

Thermo Scientific Dionex UltiMate 3000 Series

Fluorescence Detectors FLD-3100 and FLD-3400RS

Operating Instructions (Original Operating Instructions)



Revision: 1.3

Date: September 2013

© 2013 Thermo Fisher Scientific Inc.

Doc. No. 4820.7850



Declaration of Conformity

(Original Declaration of Conformity)

Product: Thermo Scientific Dionex UltiMate 3000 - Detector

Types: **FLD-3100** and **FLD-3400RS**

Dionex Softron GmbH herewith declares conformity of the above products with the respective requirements of the following regulations:

- Low-Voltage Directive 2006/95/EC
- EMC Directive 2004/108/EC

The electrical safety of the products was evaluated based on the following standard:

- DIN EN 61010-1:2010
Safety requirements for electrical equipment for measurement, control and laboratory use, Part 1: General Requirements

The Electromagnetic Compatibility (EMC) of the products was evaluated based on the following standard:

- DIN EN 61326:2006
Electrical equipment for measurement, control and laboratory use
EMC Requirements

This declaration is issued for the manufacturer

Dionex Softron GmbH
Part of Thermo Fisher Scientific Inc.
Dornierstraße 4
D-82110 Germering

by the Managing Director, Rüdiger Obst, and
the Vice President HPLC, Fraser McLeod.

September 2, 2013

Table of Contents

1	Introduction.....	1
1.1	How to Use This Manual	1
1.2	Safety	3
1.2.1	Symbols on the Instrument and in the Manual	3
1.2.2	Safety Precautions	5
1.2.3	Consignes de Sécurité.....	8
1.3	Intended Use	12
1.4	Federal Communications Commission (FCC) Note.....	14
2	Overview.....	15
2.1	Unit Description.....	15
2.2	Operating Principle	16
2.3	Configurations	19
2.4	Interior Components	20
2.5	Front Panel Elements	21
2.6	Rear Panel	22
2.6.1	Power Switch.....	22
2.6.2	Fuse Cartridge	22
2.6.3	USB Port.....	23
2.6.4	Analog Outputs (Optional).....	23
2.7	Fluid Connections	23
2.8	Flow Cells	24
2.9	Lamp	25
2.10	Leak Sensor.....	25
2.11	Detector Control	26
2.12	System Wellness, Predictive Performance, and Diagnostics.....	27
3	Installation.....	29
3.1	Facility Requirements	29
3.2	Unpacking	30
3.3	Positioning the Detector in the UltiMate 3000 System	31
3.4	Connecting the Detector	32
3.4.1	General Information	32
3.4.2	Connecting the USB Cable.....	32
3.4.3	Connecting the Power Cord.....	34
3.4.4	Connecting the Analog Outputs (Optional).....	34
3.5	Setting Up the Detector in Chromeleon.....	37
3.5.1	Loading the USB Driver for the Detector	37
3.5.2	Installing the Detector	39
3.5.3	Configuring the Detector	40
3.6	Setting Up the Detector in DCMSLink.....	44

4	Preparation for Operation (Startup)	45
4.1	Overview	45
4.2	General Precautions for Connecting Capillaries	46
4.3	Connecting the Drain System	47
4.4	Installing the Flow Cell	48
4.5	Equilibrating the System	51
4.6	General Guidelines for Detector Operation	52
4.6.1	Mobile Phases	52
4.6.2	Mobile Phase Delivery System	53
4.6.3	Flow Cells	53
5	Operation and Maintenance	55
5.1	Power-Up	55
5.2	Detector Display	55
5.3	Menus on the Detector Display	57
5.3.1	Detector Menus	58
5.3.2	General Menu Layout and Structure	59
5.3.3	Main Menu	61
5.3.4	Configuration Menu	62
5.3.5	Diagnostics Menu	63
5.3.6	Service Menu	63
5.4	Operation with Chromeleon	64
5.4.1	Connecting to Chromeleon	64
5.4.2	Direct Control	65
5.4.3	Automated Control	67
5.4.4	SmartStartup and SmartShutdown	71
5.5	Operational Settings	72
5.5.1	Detecting Liquid Leaks in the Detector	72
5.5.2	Adjusting the screen brightness or contrast	72
5.6	Operational Modes of the Detector	73
5.6.1	Single-Channel Mode	73
5.6.2	Multi-Channel Mode (FLD-3400RS Only)	73
5.6.3	Zero Order Mode	74
5.6.4	2D Scans	74
5.6.5	3D Scans (only Chromeleon 7.1 or later)	76
5.7	Optimizing Detector Performance	77
5.7.1	Determining the Optimum Excitation and Emission Wavelength	78
5.7.2	Sensitivity (Detector Sensitivity)	81
5.7.3	Filter Wheel Setting (FLD-3400RS only)	85
5.7.4	Response Time and Data Collection Rate	86
5.7.5	Multi-Channel Performance	87
5.7.6	Flow Cell Temperature	88
5.7.7	Lamp Mode	88
5.7.8	Baseline Behavior	89
5.8	Monitoring System Functions	90
5.8.1	Wavelength Calibration and Verification	90

5.8.2	Recording the Flow Cell Temperature	92
5.8.3	Predictive Performance.....	92
5.8.4	Operational Qualification and Performance Qualification.....	92
5.9	Shutting Down the Detector	93
5.10	Routine and Preventive Maintenance Intervals	95
6	Troubleshooting.....	97
6.1	Overview.....	97
6.2	Messages on the Detector Display.....	98
6.3	Operating Problems	102
7	Service.....	107
7.1	General Notes and Safety Precautions.....	107
7.2	Lamp.....	108
7.3	Flow Cell.....	109
7.3.1	Flushing the Flow Cell	109
7.3.2	Replacing the Flow Cell	110
7.4	Drying the Leak Sensor	113
7.5	Replacing the Main Power Fuses.....	114
7.6	Updating the Detector Firmware	115
8	Technical Information.....	117
9	Accessories, Consumables, and Spare Parts	119
9.1	Standard Accessories	119
9.2	Optional Accessories	120
9.3	Consumables and Spare Parts	121
10	Appendix: Common Mobile Phases	123
11	Index.....	125

1 Introduction

1.1 How to Use This Manual

The layout of this manual is designed to provide quick reference to the sections of interest to the reader. However, in order to obtain a full understanding of your Thermo Scientific™ Dionex™ detector, Thermo Fisher Scientific recommends that you review the manual thoroughly before beginning operation.

All descriptions in the manual apply to the following variants of the fluorescence detector in the UltiMate™ 3000 series:

- FLD-3100
- FLD-3400RS

The following conventions apply to the descriptions throughout this manual:

- The term "the detector" or "the device" is used throughout the manual. If some detail applies to only one version, the detector is identified by name.
- If not otherwise stated, the descriptions for the Viper™ capillary connections apply also to the nanoViper™ and possible other Viper capillary connections.
- The device configuration may vary. Therefore, not all descriptions necessarily apply to your particular module.
- The representation of a component in this manual may be slightly different from the real component. However, this does not influence the descriptions.
- The descriptions in this manual refer to firmware version 1.41 and Chromeleon™ 6.80 Service Release 13. If you want to operate the detector from Chromeleon 7, note the information on page 26.

This manual is provided "as is". Every effort has been made to supply complete and accurate information and all technical specifications have been developed with the utmost care. The information contained in this manual should not be construed as a commitment by Thermo Fisher Scientific. Thermo Fisher Scientific assumes no responsibility for any errors that may appear in this document. This document is believed to be complete and accurate at the time of publication. In no event shall Thermo Fisher Scientific be liable for incidental or consequential damages in connection with or arising from the use of this document.

The information contained in this document is subject to change without notice.

All rights reserved, including those for photomechanical reproduction and storage on electronic media. No part of this publication may be copied or distributed, transmitted, transcribed, stored in a retrieval system, or transmitted into any human or computer language, in any form or by any means, electronic, mechanical, magnetic, manual, or otherwise, or disclosed to third parties without the express written permission of Thermo Fisher Scientific Inc.

Trademarks

Analyst is a registered trademark of AB Sciex.

Compass and Hystar are trademarks of Bruker Daltonics.

Empower is a registered trademark of Waters Corp.

PEEK is a trademark of Victrex PLC.

LiChrosolv is a registered trademark of Merck KGAA.

Windows and Windows Vista are registered trademarks of Microsoft Corp.







All other trademarks are property of Thermo Fisher Scientific Inc. and its subsidiaries.

1.2 Safety





The CE Mark label and cTUVus Mark safety label on the instrument indicate that the detector is compliant with the related standards.

1.2.1 Symbols on the Instrument and in the Manual

The table shows the symbols used on the instrument:

Symbol	Description
	Alternating current—Courant alternatif
	Power supply is on (-)—L'instrument est mis sous tension (-) and Power supply is off (O)—L'instrument est mis hors tension (O)
	Surface becomes hot during operation—La surface devient chaude lors du fonctionnement.
	Refer to the Operating Instructions to prevent risk of harm to the operator and to protect the instrument against damage. Référez-vous à ce manuel pour éviter tout risque de blessure à l'opérateur et/ou protéger l'instrument contre tout dommage
	Label according to the "Measures for Administration of the Pollution Control of Electronic Information Products" (China RoHS) guideline Étiquette "Measures for Administration of the Pollution Control of Electronic Information Products" (China RoHS)
	WEEE (Waste Electrical and Electronic Equipment) label—For more information, see the WEEE Information section in the "Installation and Qualification Documents for Chromatography Instruments" binder. Étiquette WEEE (Waste Electrical and Electronic Equipment)—Pour plus d'informations, référez-vous au chapitre WEEE Information dans le classeur "Installation and Qualification Documents for Chromatography Instruments"

At various points throughout the manual, messages of particular importance are indicated by certain symbols:

-  **Tip:** Indicates general information, as well as information intended to optimize the performance of the instrument.
-  **Important:** Indicates that failure to take note of the accompanying information could cause wrong results or may result in damage to the instrument.
-  **Important:** Indique que ne pas tenir compte de l'information jointe peut conduire à de faux résultat ou endommager l'instrument.
-  **Warning:** Indicates that failure to take note of the accompanying information may result in personal injury.
-  **Avertissement:** Indique que ne pas tenir compte de l'information jointe peut entraîner des blessures corporelles.

1.2.2 Safety Precautions

When working with analytical instrumentation, you must know the potential hazards of using chemical solvents.

 **Tip:** Before initial operation of the detector, make yourself familiar with the contents of this manual.

For the safety precautions in French, see page 8.

 **Warning:** All users of the device must observe the following safety precautions and all additional safety precautions in this manual to avoid the possibility of personal injury or damage to the device when operating the device or carrying out any maintenance or service procedures.

Observe any warning labels on the device and see the related sections in these *Operating Instructions*.

- **Protective equipment**

When performing any work on or near the HPLC system, wear personal protective equipment (protective clothing, safety gloves, safety glasses) as required by the hazard of the mobile phase and sample. For information about the proper handling of a particular substance and for advice on specific hazards, refer to the material safety data sheet for the substance you are using. Observe the guidelines of Good Laboratory Practice (GLP).

An eyewash facility and a sink should be close to the device. If any substance splashes on the eyes or skin, wash the affected area and seek medical attention.

- **Hazardous substances**

Many organic solvents, mobile phases, and samples are harmful to health. Be sure that you know the toxic and infectious properties of all substances that you are using. You may not know the toxic or infectious properties of many substances that you are using. If you have any doubt about a substance, treat it as if it contains a potentially harmful substance. For advice on the proper handling of a particular substance, refer to the Safety Data Sheet (SDS) of the manufacturer. Observe the guidelines of Good Laboratory Practice (GLP).

Dispose of waste substance in an environmentally safe manner that is consistent with all local regulations. Do not allow flammable, toxic, and/or infectious substances to accumulate. Follow a regulated, approved waste disposal program. Never dispose of flammable, toxic, and/or infectious substances through the municipal sewage system.

- **Hazardous gases**

Install the HPLC system in a well-ventilated laboratory. If the mobile phase or sample includes volatile or flammable solvents, do not allow them to enter the workspace. If the mobile phase or sample includes volatile or flammable solvents, avoid open flames and sparks.

- **Electrostatic discharge**

Discharge of electrostatic energy may lead to sparking and can constitute a fire hazard. Keep in mind that liquid flowing through capillaries can generate static electricity. This effect is particularly pronounced in insulating capillaries and with non-conductive solvents (for example, pure acetonitrile).

Take appropriate measures to prevent the generation of static electricity near the HPLC system. For example, make sure that the air humidity level in the laboratory is sufficiently high and provide proper ventilation, wear anti-static clothing or shoes, prevent accumulation of air bubbles in waste lines, and use grounded waste containers. Use only non-conductive capillaries to direct solvents into the waste container. With electrically conductive capillaries, make sure that they are properly grounded.

- **Self-ignition of solvents**

Do not use solvents for which the self-ignition temperature is below 150 °C. In case of leakage, these solvents may self-ignite on a hot surface.

- **Capillaries, capillary connections, open connections**

- ◆ Capillaries, especially non-metallic capillaries may burst, slip out of their fittings or may not be screwed in. This may result in substances spraying out of the open connections.
- ◆ In an UltiMate 3000 system, some components are made of PEEK™. This polymer has superb chemical resistance to most organic solvents. However, it tends to swell when in contact with trichloromethane (CHCl₃), dimethyl sulfoxide (DMSO), or tetrahydrofuran (THF). In addition, it is attacked by concentrated acids, such as, sulfuric acid and nitric acid or a mixture of hexane, ethyl acetate, and methanol. In both cases, capillaries may start leaking or they can burst. Swelling or attack by concentrated acids is not a problem with brief flushing procedures.
- ◆ Do not use tubing that is stressed, bent, kinked, or damaged.
- ◆ Capillary connections can be contaminated by harmful substances or harmful substances can escape from open connections.
- ◆ Always wear safety glasses when handling fused silica tubing, for example, during installation or when cutting capillaries to the length.

- **Hot surfaces**

- ◆ During operation, the lamps and the surrounding parts become extremely hot and remain so for some time after the detector is turned off. To avoid possible injury, allow sufficient time for the lamp to cool down after turning off the detector. Only then start with the maintenance and repair work.
- ◆ Flow cells can become extremely hot during operation. To avoid possible injury, allow sufficient time for the flow cell to cool down before replacing the cell.

- Disconnect the detector from all power sources before removing the panels. When the panels are removed, dangerous electrical connections will be exposed. The enclosure must be opened only by Thermo Fisher Scientific service personnel.

- Always replace blown fuses with original spare part fuses authorized by Thermo Fisher Scientific.
- Replace faulty communication cables.
- Replace faulty power cords. Never use a power cord other than the power cords provided for the device.
- Use only the original spare parts and accessories authorized for the device by Thermo Fisher Scientific.
- When lifting or moving the detector, always lift the unit by the bottom sides or sides. Do not lift the detector by the front panel door. This may damage the door.
- Do not place any heavy objects on the open front panel door. This may damage the door.
- After operation, rinse out buffers and solutions that form peroxides.
- Before switching from buffer to organic solution, rinse the analytical system thoroughly with deionized or HPLC grade water.
- When switching to another solvent, ensure that the new solvent is miscible with the one contained in the HPLC system. If the solvents are not miscible, the system can be damaged, for example, by flocculation.
- If a leak occurs, turn off the instrument and remedy the situation immediately.
- Use only standard solvents (HPLC grade or fluorescence grade for highest sensitivity) and buffers that are compatible with all parts that may be exposed to solvents.
- Before interrupting operation for several days or more or when preparing the detector for transport, observe the precautions for shutting down the detector (→ page 93).
- Do not use the detector in ways other than those described in these *Operating Instructions*.
- Keep the operating instructions near the device to be available for quick reference.

1.2.3 Consignes de Sécurité

Si vous utilisez d'instrumentation analytique, vous devez connaître les risques d'utilisation de produit chimiques.

 **Veillez noter:** Avant de commencer à utiliser l'instrument, assurez-vous que vous vous êtes familiarisés avec le contenu de ce manuel.

 **Avertissement:** Toutes les personnes utilisant l'instrument doivent observer les consignes de sécurité suivantes et dans les autres chapitres de ce manuel pour éviter une mise en danger de sa personne ou de dommage à l'instrument pendant l'utilisation et des opérations de maintenance ou service de l'instrument.

Observez les étiquettes d'avertissement sur l'instrument et référez-vous aux sections correspondantes dans ce mode d'emploi.

- **Equipment de protection**

Pour tous les travaux sur le système HPLC ou à proximité, portez l'équipement de protection personnel (vêtements de protection, gant de sécurité, lunettes de protection) qui correspond aux risque découlant de la phase mobile et/ou de l'échantillon. Pour les informations sur la manipulation correcte des composés et des recommandations pour les situations de risque spécifiques, veuillez consulter la fiche de données de sécurité des substances que vous utilisez. Veuillez respecter des directives des Bonnes Pratiques de Laboratoire (BPL).

Une installation permettant de se laver les yeux ainsi qu'un lavabo doivent se trouver à proximité du système. Si une substance, quelle qu'elle soit, entre en contact avec vos yeux ou votre peau, rincez abondamment la zone affectée à l'eau, puis.

- **Substances dangereuses**

De nombreux solvants organiques, phases mobiles et échantillons sont nuisibles à la santé. Informez-vous de propriétés toxicologiques et infectieuses de toutes les substances que vous utilisez. Les propriétés toxicologiques et infectieuses de nombreuses substances peuvent être mal connues. Au moindre doute concernant une substance, traitez-la comme s'il contenait une substance potentiellement dangereuse. Pour des instructions comment utiliser correctement des composés particuliers, veuillez consulter à la fiche de données des sécurités du fabricant respectif. Veuillez respecter des directives des Bonnes Pratiques de Laboratoire (BPL).

Débarrassez-vous de tous les déchets de substances de manière écologique, conformément à la réglementation en vigueur au niveau local. Empêchez impérativement l'accumulation de solvants inflammables, toxiques et/ou infectieux. Suivez un programme d'élimination des déchets règlementé et approuvé. Ne jetez jamais de solvants inflammables, toxiques et/ou infectieux dans le système municipal d'évacuation des eaux usées.

- **Gaz dangereux**

Installez le système HPLC dans un laboratoire bien ventilé. Si la phase mobile ou l'échantillon contient des solvants volatils ou inflammables, vous devez assurer qu'ils ne pénètrent dans l'espace de travail. Si la phase mobile ou l'échantillon contient des solvants volatils ou inflammables, évitez les flammes nues et les sources d'étincelles à proximité.

- **Décharge électrostatique**

Décharge électrostatique peut provoquer la formation d'étincelles et peut présenter un risque d'incendie. Veuillez noter que des solvants fluides dans les capillaires peuvent se charger automatiquement. Cet effet se peut produire particulièrement forte dans les capillaires isolants et avec des solvants non-conducteurs (par exemple, l'acetonitrile pur).

Prenez des mesures appropriées pour éviter les charges électrostatiques à proximité du système HPLC. Par exemple, s'assurez qu'il y a une humidité de l'air suffisante et une ventilation adéquate dans la laboratoire, portez des vêtements ou équipement de protection antistatique, évitez l'accumulation de bulles d'air dans les lignes de déchets et utilisez des réservoirs à déchets mis à la terre.

Utilisez uniquement des capillaires non-conducteurs pour diriger solvants au réservoir de déchets. Capillaires électriquement conducteur devrait être mis à la terre.

- **Inflammation spontanée des solvants**

N'utilisez aucun solvants avec une température d'auto-inflammabilité inférieure à 150° C. Si une fuite se produit, ces solvants peuvent s'auto-enflammer au contact d'une surface chaude.

- **Capillaires, connecteur capillaires, connexions ouvertes**

- ◆ Des capillaires, en particulier les capillaires non-métalliques, pourraient fendre ou glisser des connecteurs ou ne peuvent pas être vissés. Ceci peut en résulter aussi que des substances pourraient jaillir des connexions ouvertes.
- ◆ Dans un système UltiMate 3000, certaines composantes sont en PEEK. Bien que ce polymère présente une excellente résistance chimique à la plupart des solvants organiques, il a tendance à gonfler lorsqu'il est en contact prolongé avec du chloroforme (CHCl₃), du diméthyle sulfoxyde (DMSO) ou du tétrahydrofurane (THF). De plus, il est attaqué par des acides concentrés tels que l'acide sulfurique et l'acide nitrique ou d'un composé du hexane, éthyle acétate et méthanol. Ceci peut causer des capillaires de fuite ou risquer des capillaires d'éclater. Ces acides peuvent cependant être utilisés dans le cadre de procédures de nettoyage, à condition que l'exposition soit brève.
- ◆ N'utilisez pas de capillaires écrasés, pliés, abimés ou endommagés.
- ◆ Les connecteurs capillaires pour pourrait être contaminé par des substances dangereuses ou des substances dangereuses pourrait sortir des connexions ouvertes.

- ◆ Dans un système UltiMate 3000 Bio RS, certains capillaires du système Viper sont faits d'alliage de nickel-cobalt MP35N. Contact avec la peau peut provoquer une réaction chez les personnes qui sont sensibles au nickel/cobalt.
- ◆ Portez des lunettes de protection lorsque vous manipulez des capillaires en silice fondue (pendant l'installation, découpe, etc.).
- **Surface chaude**
 - ◆ Lampes et les parties environnantes deviennent très chaudes pendant le fonctionnement. Pour éviter toute blessure, vous attendez après mise hors tension jusqu'à ce que les lampes soient refroidies. Commencer seulement alors les travaux d'entretien.
 - ◆ Les cellules de mesure peuvent devenir très chaudes pendant le fonctionnement. Pour éviter toute blessure, vous attendez jusqu'à ce que la cellule est refroidi avant de remplacer le capteur.
- Quand les capots de protection de l'appareil sont démontés, vous êtes exposés à des connexions électriques sous haute tension deviennent accessibles. Débranchez l'instrument de toute source d'alimentation électrique avant de retirer les capots. Ne démontez les capots de protection que si cela est explicitement demandé au cours de ces instructions. Les capots de protection devraient être démontés uniquement par le personnel de service de Thermo Fisher Scientific.
- Remplacez toujours les fusibles grillés par des fusibles de rechange autorisés par Thermo Fisher Scientific (→ page 114).
- Remplacez les câbles de communication défectueux.
- Remplacez les cordons d'alimentation électrique défectueux. Utilisez uniquement les cordons d'alimentation électrique spécifique à l'instrument.
- Utilisez seulement des pièces de rechange originales et des accessoires autorisés par Thermo Fisher Scientific.
- Réglez toujours une limite de pression minimum pour le système HPLC. Ceci prévient les dommages résultant de fuites ou du fonctionnement à sec de la pompe.
- Lorsque vous soulevez ou l'instrument, tenez-le toujours par le dessous ou par les côtés de l'unité. Soulever l'instrument par la partie avant inférieure ou par le panneau avant peut endommager la porte.
- Ne placez aucun objet lourd sur la porte ouverte du panneau avant. Ceci pourrait endommager la porte.
- Après utilisation, purgez le système des tampons et des susceptibles de former des peroxydes.
- Lorsque vous passez d'une solution saline à un solvant organique, effectuez un rinçage intermédiaire du système HPLC à l'eau dé-ionisée ou qualité HPLC.

- Lorsque vous passez à un autre solvant, assurez-vous que le nouveau solvant soit miscible avec celui qui se trouve dans le système HPLC. Dans le cas contraire, le système HPLC peut être endommagé; par exemple, par des floculations!
- Si une fuite se produit, arrêtez immédiatement l'instrument, stoppez le débit de la pompe et remédiez au problème.
- Utilisez uniquement des solvants de qualité HPLC ou qualité fluorescence (pour maximiser la sensibilité) et des solutions salines compatibles avec les matériaux exposés phase mobiles.
- Avant d'interrompre le fonctionnement pendant plusieurs jours ou plus, observez les précautions figurant en page 114).
- De nombreux solvants organiques et solutions salines sont toxiques. Informez-vous des propriétés toxicologiques de toutes les phases mobiles que vous utilisez.
- N'utilisez pas l'instrument de manière autre que celles décrites dans ce manuel.
- Conservez ce manuel à proximité de l'instrument pour pouvoir le consulter facilement.

1.3 Intended Use

For Research Use Only. Not for use in diagnostic procedures. The device is designed to be operated only by qualified and authorized personnel. All users must know the hazards presented by the device and the used substances.

The detector is designed for laboratory research use in high-performance liquid chromatography (HPLC) or ultra-high performance liquid chromatography (UHPLC) applications. It is part of the UltiMate 3000 system, but can be used also with other HPLC systems if adequate control inputs and outputs are available.

The detector can be controlled by the Chromeleon Chromatography Management System. Being part of the UltiMate 3000 system, the detector can also be operated with other data systems, such as

- Xcalibur™, Compass™/HyStar™, or Analyst®. Installation of the DCMS^{Link} (Thermo Scientific Dionex Chromatography Mass Spectrometry Link) software is required in addition to the installation of the data system.
- Empower™. Installation of the Thermo Scientific Dionex Instrument Integration Software is required in addition to the installation of the data system.

For more information, contact the Thermo Fisher Scientific sales organization for Dionex HPLC Products.

Keep the following in mind:

- Note that the detector may be operated only with accessories and spare parts recommended by Thermo Fisher Scientific (→ page 119) and within its technical specifications (→ page 117).
- Note the special properties of the solvents, such as the viscosity, boiling point, and UV absorption (UV/VIS detector). Also observe the information about the solvent compatibility of the other UltiMate 3000 system modules. For more information, refer to the Operating Instructions for the modules.
- Buffer concentration: Typically up to 1 mol/L (< 0.1 mol/L chloride ions).
- Also observe the information about the solvent compatibility and buffer concentrations of the other UltiMate 3000 system modules. For more information, refer to the Operating Instructions for the modules.

If there is any question regarding appropriate usage, contact Thermo Fisher Scientific before proceeding.



Warning:

If the device is used in a manner not specified by Thermo Fisher Scientific, the protection provided by the device could be impaired. Thermo Fisher Scientific assumes no responsibility and will not be liable for operator injury and/or instrument damage. Whenever it is likely that the protection is impaired, the instrument must be disconnected from all power sources and be secured against any intended operation.



Avertissement:

Si l'instrument est utilisé de façon non spécifiée par Thermo Fisher Scientific, la protection prévue par l'instrument pourrait être altérée. Thermo Fisher Scientific n'assume aucune responsabilité et ne sera pas responsable des blessures de l'opérateur et/ou des dommages de l'instrument. Si la protection de l'instrument n'est pas garanti à tout moment, débranchez l'instrument de toutes les sources d'alimentation électrique et assurez-vous que l'instrument n'est pas utilisé involontairement.

1.4 Federal Communications Commission (FCC) Note

This equipment has been tested and found to comply with the limits for a Class A digital device, pursuant to part 15 of the U.S. FCC Rules. These limits are designed to provide reasonable protection against harmful interference when the equipment is operated in a commercial environment. This equipment generates, uses, and can radiate radio frequency energy and, if not installed and used in accordance with the instruction manual, may cause harmful interference to radio communications. Operation of this equipment in a residential area is likely to cause harmful interference, in which case the user will be required to correct the interference at his expense.

2 Overview

2.1 Unit Description

The detector is a high-quality instrument designed for HPLC analysis as part of the UltiMate 3000 system.

- A xenon flash lamp is used to excite a wavelength range of 200 to 880 nm.
- With the unique Dual-PMT option, the wavelength range can be extended to the near infrared spectral region (up to 900 nm) *without* any loss in sensitivity in the UV/VIS spectral region.
- Data collection rates in single channel mode of up to 100 Hz (FLD-3100) or up to 200 Hz (FLD-3400RS under Chromeleon 7) allow rapid separations in UHPLC. The wavelength switching time is < 250 ms.
- The detector is optimized for high sensitivity (signal-to-noise ratio higher than 550 for the Raman spectrum of water), over the entire lifetime of the lamp. It is thus possible to detect even smallest peaks.
- The flow cells are equipped with an active temperature control to ensure improved reproducibility when ambient temperatures fluctuate.
- To suppress the higher-order radiation typical of grating spectrometers and scattering of light, the detector is equipped with an optical filter. Users can select the wavelength range that is suppressed by the filter for FLD-3400RS detectors.
- The FLD-3400RS can measure up to four channels (2D data) with independent parameters (wavelengths, sensitivity, filter wheel) simultaneously.
- The detector can be controlled by the Chromeleon Chromatography Management System. This provides a high degree of system integration, as well as maximum analysis efficiency due to comprehensive data analysis and evaluation features in Chromeleon.
- Various safety and monitoring features are provided for optimum system performance and reliability (→ page 27).
- All parts that may be exposed to solvents are made of materials that provide optimum resistance to the most commonly used solvents and buffer solutions in HPLC.

2.2 Operating Principle

Fluorescence detectors are optical detectors. In a fluorescence detector, the sample is exposed to light at a defined wavelength (excitation). The thus excited sample substance emits light at a higher wavelength (emission). The photomultiplier is positioned at an angle of 90° to the light source and detects the light that was emitted from the fluorescing substances. In contrast to UV/Vis detectors, a fluorescence detector measures a very weak light signal rather than the difference between light intensities (absorbance).



Fig. 1: Simplified presentation of absorption in a molecule

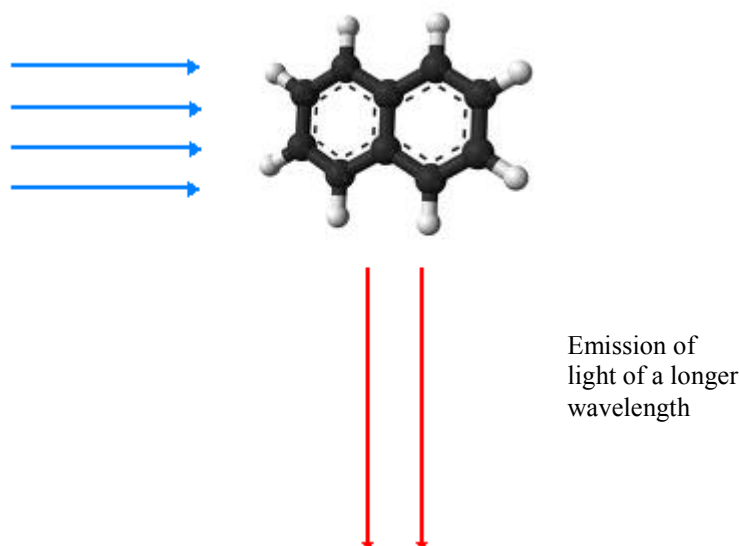

Fig. 2: Simplified presentation of the light emission in a molecule (fluorescence)

Fluorescence is used, for example, in highlighters or in whitening agents (optical brighteners). Fluorescent paint used in highlighters reacts to the blue and near, non-visible ultraviolet range of the daylight and gives off light at a longer wavelength (typically blue-green, yellow and red).

As shown in Fig. 3 (→ page 17), the light beam from the xenon lamp (no. 1) is focused by the lamp optics (no. 2) through the entrance of the excitation monochromator (no. 3). The excitation monochromator transmits only light of the user-selected wavelength to the sample inside the flow cell (no. 4). Most of the light penetrates the sample. A reference detector (no. 5) behind the flow cell measures the intensity of this light. The excitation light stimulates the sample to emit fluorescence light.

When the light exits the flow cell, it is focused by the emission optics (no. 6) through the emission monochromator (no. 8).

A cut-off filter, which lets only light above a certain wavelength pass, is located before the emission monochromator. In the FLD-3100, the filter has a fixed cut-off wavelength (280 nm). In the FLD-3400RS, a filter wheel (no. 7) is installed. With the help of a motor the wheel can be moved to 5 different positions with different cut-off wavelengths. The selectable filter helps to achieve an even better sensitivity and increase flexibility during method development.

The emission monochromator transmits only the light with the user-selected emission wavelength to a photomultiplier tube (PMT) (no. 9), where the light is measured. A second optional red-sensitive photomultiplier tube (no. 10) measures light in the near infrared region (up to 900 nm).

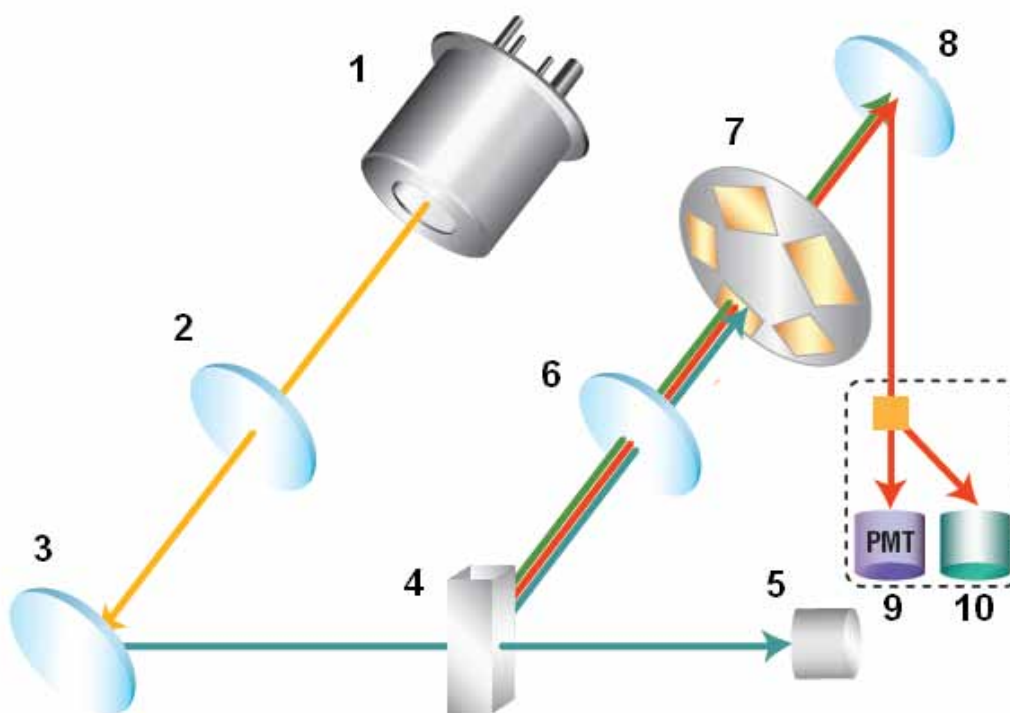

Fig. 3: Optics setup (schematic)

No.	Component	Description
1	Xenon lamp	Light source for the UV to near-infrared wavelength range
2	Lamp optics	Receives the light beam emitted from the xenon lamp and focuses it so that the beam passes through the excitation monochromator.
3	Excitation monochromator	Lets only light with the selected excitation wavelength pass.
4	Flow cell	The eluent with the analyte travels through the flow cell. The excitation light passes through the flow cell to the reference detector, the fluorescence light exits the flow cell at an angle of 90° to the excitation light.
5	Reference detector	Measures the excitation light intensity through the flow cell.
6	Emission optics	Receives the light beam emitted from the flow cell and focuses it so that the beam passes through the emission monochromator.
7	Filter wheel	Carries the optical filter, which is used to cut off light up to a certain wavelength. The FLD-3400RS provides five filter positions with different cut-off wavelengths.
8	Emission monochromator	Lets only light with the selected emission wavelength pass.
9	PMT	Photomultiplier tube (PMT) - Converts the emitted light to a measureable current signal.
10	Second PMT	(Optional) A second red-sensitive photomultiplier tube measures light in the near infrared region (up to 900 nm).

2.3 Configurations

The detector is available in the following configurations:

Detector Description	Part no.
FLD-3400RS detector for measurements up to 200 Hz*. Up to four wavelengths can be recorded simultaneously.	5078.0020
FLD-3400RS detector with Dual-PMT	5078.0025
FLD-3100 detector for measurements up to 100 Hz. However, only one wavelength can be recorded.	5078.0010
FLD-3100 detector with Dual-PMT	5078.0015

*Only with Chromeleon 7.1 or later

Dual-PMT

The variants of the FLD with Dual PMT are equipped with a second PMT for the near infrared region (up to 900 nm) (→ no. 10, Fig. 3, page 17). Depending on the PMT setting, the instrument selects the suitable PMT for each measurement, or you can manually select which PMT should be used. For emission scans, you can scan with both PMTs simultaneously.

Detectors with a single PMT can later be upgraded with a second PMT by the Thermo Fisher Scientific Service for Dionex HPLC Products.

2.4 Interior Components

The front panel door tilts downward to provide easy access to the inside front panel, for example, for maintenance and repair work.

⚠ Important: The open front panel door is not designed to carry weight. Therefore, you should not place any objects on the open front panel door.

⚠ Important: Ne placez aucun objet lourd sur la porte ouverte du panneau avant. Ceci pourrait endommager la porte.

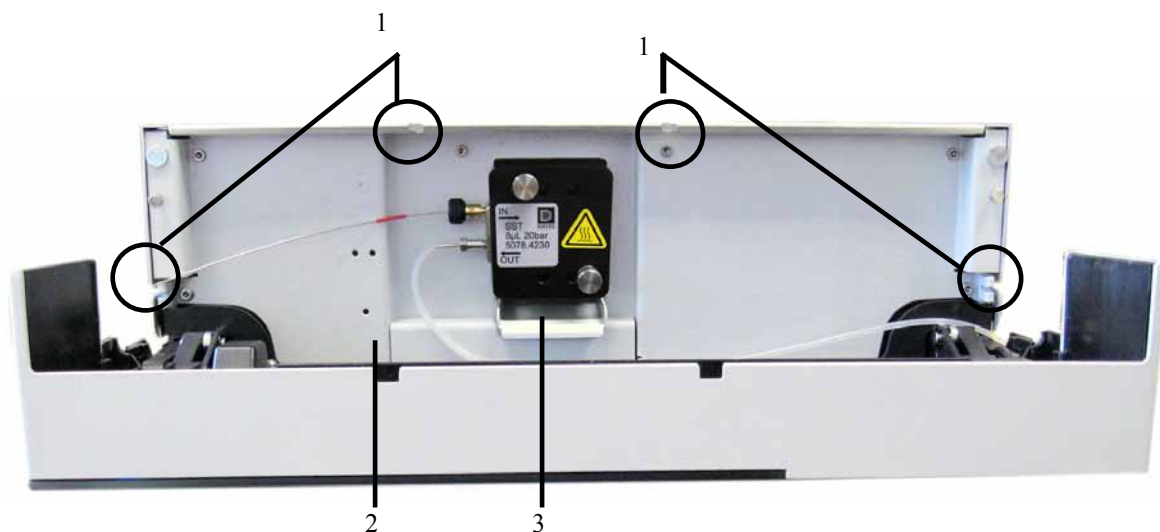

Fig. 4: Interior view from the front

No.	Description
1	Slots in the enclosure to route the flow cell capillaries to the outside (→ page 23) Two more slots with capillary guides are provided in the enclosure bottom.
2	Leak sensor (→ page 25)
3	Flow cell No flow cell is installed when the detector is shipped. Before initial operation, install a flow cell.

2.5 Front Panel Elements



Fig. 5: Front panel view

No.	Front Panel Element	Function
1	Display	Shows information about the detector: <ul style="list-style-type: none"> - General information upon power up (→ page 55) - Status screen, depending on the operating mode (→ page 55) - Various menus, accessible via the menu key (→ page 57) - Messages (→ page 97)
2	Standby button	Switches the detector to Standby mode (the LED is lighted). To cancel Standby mode and resume operation, press the Standby button again (the LED is not lighted). Note: To allow the detector to change the mode, press the Standby button for at least one second.
3	LEDs	
	Power	The LED is blue when the detector is on.
	Connected	The LED is green when the detector is controlled by Chromeleon.
	Status	The LED is red when an error has been detected, e.g. when the lamp has failed. In addition, the corresponding message appears on the front panel display (→ page 97). The LED is orange, for example, when the detector is booting. Otherwise, the LED is green.

2.6 Rear Panel

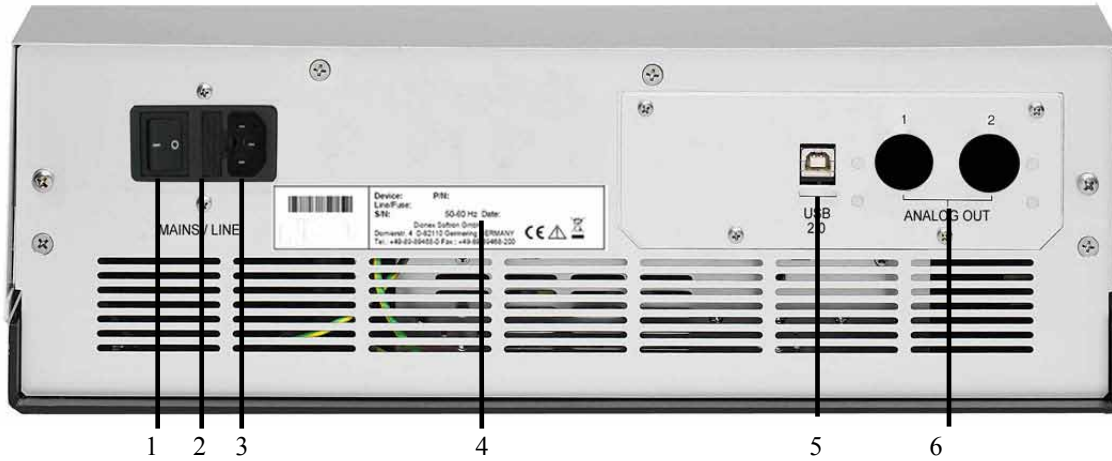

Fig. 6: Rear panel

No.	Description
1	Power switch (→ page 22)
2	Fuse cartridge (→ page 22)
3	Main power receptacle (→ page 34)
4	Type label
5	USB 2.0 (Universal Serial Bus) port for connection to the Chromeleon computer (→ page 23)
6	Analog outputs (optional, → page 34)

2.6.1 Power Switch

The power switch on the rear panel is the main power switch for the detector. Turn on the power switch before initial operation of the detector and leave it on. For routine operation, leave the main power switch on. For routine on/off control, use the standby button on the front of the detector (→ page 21). Press and hold the button for about one second to allow the detector to change the mode. Turn off the main power switch when instructed to do so, for example, before performing a service procedure or when interrupting operation for longer periods (one week or more). Observe the precautions on page 93.

2.6.2 Fuse Cartridge

The fuse cartridge contains two slow-blow fuses, rated at 2 A (5 x 20 mm). For information about how to change the fuses, see page 114.

2.6.3 USB Port

The Chromeleon Chromatography Management System uses a USB connection to control the detector. Data is transferred digitally via the appropriate USB cable (→ page 32). The PC must be equipped with a USB port. To ensure trouble-free operation, use only the cables shipped with the detector.

For information about how to connect the detector to the Chromeleon computer, see sections 3.4.1 and 3.4.2 (→ page 32).

2.6.4 Analog Outputs (Optional)

If the optional DAC plug-in module (part no. 6078.0305) is installed, two analog outputs with a resolution of 20 bits each are provided. The outputs can be connected to additional evaluation devices. The analog output voltages are updated with the data rate selected in Chromeleon (Data Collection Rate), however, not exceeding a maximum data rate of 50 Hz. For information about how to install the board, see page 34. For configuration details, see page 36.

2.7 Fluid Connections

The detector is designed to provide easy access to the fluid components. Tilt the front cover downward. At dedicated positions in the front part of the enclosure, six slots are provided for the capillaries: on the top and bottom of the enclosure (two slots each), and on the left and right side of the enclosure (one slot each) (→ Fig. 4, page 20).

Capillary guides on the bottom slots facilitate routing the capillaries to devices that are located underneath the detector in the UltiMate 3000 system stack.

When closing the front panel door, avoid bending the capillaries and make sure that they are routed to the outside through these slots.

i **Tip:** The volume between the column and the flow cell should be as low as possible to avoid peak broadening effects and the accompanying loss of chromatographic efficiency. Preferably use Viper capillaries to prevent dead volume.

2.8 Flow Cells

The detector is shipped without a flow cell. The following flow cells are available for the detector:

Flow cell type	Flow cell material	Flow cell volume	Volume Heat exchanger and/or inlet capillary	Part no.
Analytical, pressure limit: 20 bar	Fused silica, stainless steel, PTFE	8 μ L, \varnothing inlet capillary 0.18 mm	6.3 μ L	6078.4230
Micro, pressure limit: 40 bar	Fused silica, stainless steel, PTFE	2 μ L, \varnothing inlet capillary 0.13 mm	3.3 μ L	6078.4330

All parts of the flow cell that are exposed to solvents are made of fused silica, stainless steel, or PTFE (Polytetrafluorethylene).

All flow cells are optimized for fast separations with no loss in chromatographic resolution. An identification chip is fitted to the flow cell in the factory. The chip stores unique information about the flow cell, including the cell type and serial number. When the flow cell is installed, a contact on the flow cell connects the chip to the detector electronics.

The flow cells are equipped with a temperature control. Flow cell and heat exchanger can be heated to a user-defined temperature (\rightarrow page 88). The heat exchanger helps to adapt the temperature of the mobile phase to the flow cell temperature before the mobile phase enters the optical part of the cell. Note that the volume of the heat exchanger and inlet capillary indicated in the table influences the retention times and peak widths.

The micro flow cell is optimized for best resolution in UHPLC, and is recommended for use with 2.1 mm ID columns. The analytical flow cell provides higher sensitivity and a better signal-to-noise ratio with most other columns.

To ensure optimum performance of the flow cells, observe the guidelines (\rightarrow page 53).

2.9 Lamp

The light source is a xenon flash lamp with a power of 15W. The flash frequency of the lamp varies, depending on the selected lamp mode.

The lamp is turned on when data acquisition starts, and automatically turned off after data acquisition was stopped to extend its lifetime. It is not required that the lamp is turned on during the entire chromatographic separation. For example; during re-equilibration of the chromatographic column, usually no peaks of interest will elute. If you are not interested in the baseline during the wash and re-equilibration phase, you can turn off the lamp by stopping data acquisition, or set the lamp mode to a lower frequency. This will save lamp power on time or reduce the number of lamp flashes, respectively, and thus extend the lamp lifetime. In addition, you can extend the lamp lifetime by selecting a different lamp mode (→ page 88).

The lamp must be replaced only by Thermo Fisher Scientific Service for Dionex HPLC Products.

2.10 Leak Sensor

A leak sensor (→ Fig. 4, page 20) is installed inside the detector. If liquid collects in the drip tray under the fluid connections, the leak sensor reports a leak, and the **Status** LED on the front panel door changes to red. In addition, a message appears on the front panel display and in the Chromeleon Audit Trail and a beep alerts you. Leak sensor settings see page 72.

When the leak sensor reports a leak, eliminate the cause for the leakage and dry the leak sensor (→ page 113). If the sensor is not dry, the **Status** LED remains red. To remove the message from the display, select **Clear** on the navigation bar.

2.11 Detector Control

The detector can be controlled by the Chromeleon Chromatography Management System. To operate the detector with Chromeleon, an appropriate Chromeleon version and the corresponding license are required.

 **Tip:** All software details in this manual refer to *Chromeleon 6.80*, unless stated otherwise.

If you want to operate the detector with *Chromeleon 7*, refer to the following documents for information about how to perform the related processes in Chromeleon 7 (all documents are included in the Chromeleon 7 shipment):

- *Chromeleon 7 Help*—provides extensive information and comprehensive reference material for all aspects of the software.
- *Quick Start Guide*—describes the main elements of the user interface and guides you step-by-step through the most important workflows.
- *Reference Card*—provides a concise overview of the most important workflows.
- *Installation Guide*—provides basic information about module installation and configuration. For specific information about a certain module, refer to the Chromeleon 7 Instrument Configuration Manager Help.

Note the following:

- Chromeleon 7 terminology is different from the terminology used in Chromeleon 6.80. For details, refer to the Glossary, which is available in the Documents folder of your Chromeleon 7 installation.
- Chromeleon 7 may not yet support all functions supported in Chromeleon 6.80.

Two modes of software control are available:

- **Direct Control**
With direct control, you select operating parameters and commands in the **Commands (F8)** dialog box. Direct commands are executed as soon as they are entered. For routine operation, most parameters and commands are available also on a control panel. For more information about direct control, see page 65.
- **Automated Control**
With automated control, you create a program (or PGM File). This is a list of control commands, executed in chronological order, for automated operation of the detector. Programs can be created automatically with the help of a software wizard or manually by editing an existing program. For more information about automatic control, see page 67.

2.12 System Wellness, Predictive Performance, and Diagnostics

System Wellness monitors the health of the detector. Therefore, the detector supports several performance and reliability features that can help you detect small problems before they turn into big ones:

- Internal monitoring of all mechanical operations
- Automatic self test upon power up
- Monitoring the lamp age (→ page 108)
- Flow cell identification and documentation of the flow cell type (→ page 63)
- Leak sensor (→ page 25)
- General information for detector diagnostics (→ page 63)

When an error is detected, the **Status** LED on the front panel is red and a message appears on the detector display (→ page 98).

In Chromeleon, additional functions for estimating the lifetime of consumables and monitoring and recording service and (re)qualification information (= predictive performance; → page 92) are available to check the performance of the UltiMate 3000 system and certain system components, and the overall performance of the instrument.

3 Installation

3.1 Facility Requirements

The installation site must meet the following requirements:

- The main power switch and the main power receptacle are on the rear panel. Make sure that
 - ◆ Free and unrestricted access to the main power switch is ensured at all times.
 - ◆ The power cord of the device can be easily reached and disconnected from the power line at all times. Provide sufficient space behind the device to unplug the cable.
- Make sure that the installation site meets the power and environmental specifications listed in the Technical Information section (→ page 117).
- Install the detector in the laboratory on a stable surface that is free of vibrations.
- Make sure that the surface is resistant to solvents.
- Avoid locations with extreme changes in temperature.
- Avoid direct sunlight and high humidity.
- Allow sufficient clearance behind and to the sides of the detector for ventilation.

3.2 Unpacking

All electrical and mechanical components of the detector are carefully tested before the instrument is shipped from the factory. After unpacking the detector, inspect the module for any signs of mechanical damage, which might have occurred during transit.

 **Tips:** Immediately report any shipping damage to both, the incoming carrier and Thermo Fisher Scientific. Shipping insurance will compensate for the damage only if reported immediately.

Keep the original shipping container and packing material. They provide excellent protection for the instrument in case of future transit. Shipping the unit in any other packaging automatically voids the product warranty.

1. Place the shipping container on the floor and remove the accessories kit and the power cord.
2. Grasp the detector by the sides. Slowly and carefully, pull the instrument out of the shipping container and place it on a stable surface.

 **Important:** To prevent the device from falling, grasp the device by the sides, and then lift the unit together with the foam spacers out of the shipping container. Do not lift the unit by the packaging material or the front panel.

 **Important:** Afin d'empêcher l'instrument de tomber, saisissez-la par les côtés. Ne soulevez l'instrument à l'aide du matériau d'emballage ou par la porte du panneau avant.

3. Remove the foam spacers, and then remove the polythene packaging.
4. Before connecting the detector to the power source, wait approximately 4 hours to allow the instrument to come to room temperature and to allow any condensation that might have occurred during shipping to evaporate. After 4 hours, check the detector; if condensation still exists, allow the detector to continue to warm up (without connecting it to the power source) until the condensation is completely gone.

3.3 Positioning the Detector in the UltiMate 3000 System

If the detector is part of an UltiMate 3000 system, for example, for analytical HPLC applications, you should stack the individual modules. However, the arrangement of the system modules depends on the application.

- In a standard system with only one detector, where all modules are stacked, the fluorescence detector is always the *bottom* module.
- In a system that includes a UV detector in addition to the fluorescence detector, the modules can be arranged as shown in Fig. 7.

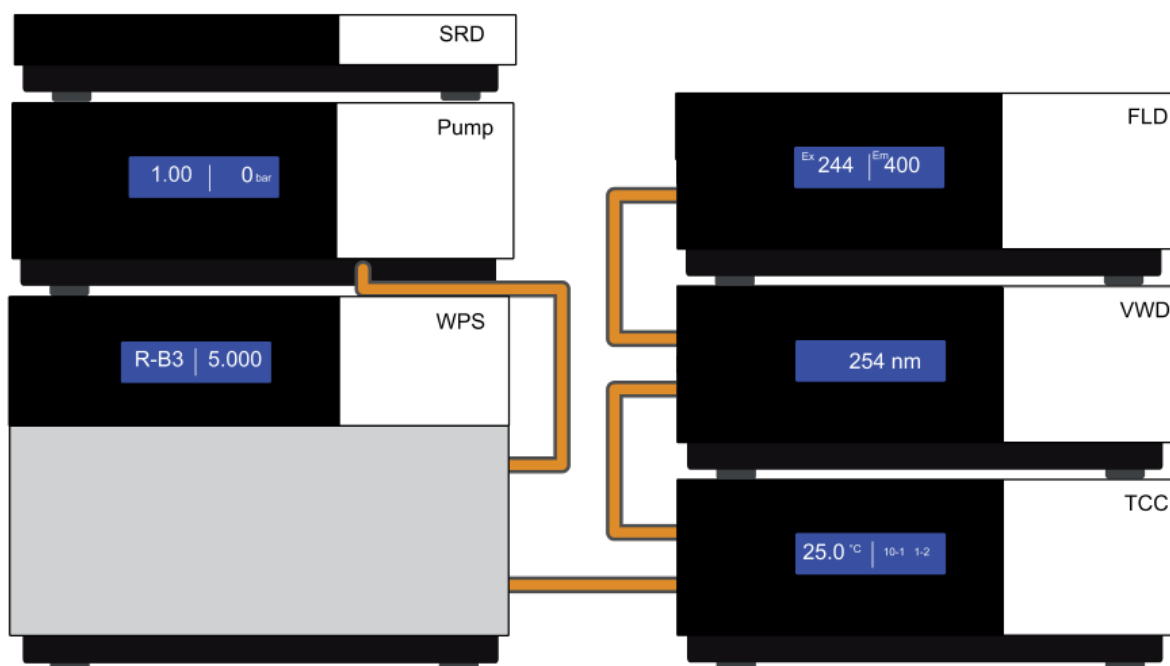

Fig. 7: Module arrangement for an UltiMate 3000 RS system with two detectors (example)

Left from top to bottom: SR-3000 solvent rack, LPG-3400RS pump, WPS-3000TRS autosampler

Right from top to bottom: FLD-3400RS fluorescence detector, UV detector (VWD-3400RS or DAD-300RS), TCC-3000RS thermostatted column compartment

i **Tip:** As the flow cell of the fluorescence detector has a pressure limit of 20 bar (analytical flow cell) or 40 bar (micro flow cell), the fluorescence detector must always be the last module in the fluidic path.

Refer to section 3.4.2 for information how to connect the USB ports on the rear panels.

3.4 Connecting the Detector

3.4.1 General Information

Verify that Chromeleon is installed on the computer and that the license code is entered *before* you connect the detector to the USB port on the Chromeleon computer and turn on the detector power. Only if you install Chromeleon first, the detector is connected to the computer and the USB driver for the detector is automatically loaded. The Windows[®] operating system can detect the detector when the power is turned on.

3.4.2 Connecting the USB Cable

Connect the detector to the Chromeleon computer via the USB port on the rear panel. Select one of the following alternatives:

- Connect the detector directly to the USB port on the computer.
- Connect the detector to an internal USB port on the pump. Thermo Fisher Scientific recommends connecting all modules to the pump, and then connecting the system to the Chromeleon computer via only one connection (→ Fig. 8, page 33). If the system includes a UV detector in addition to the fluorescence detector, Thermo Fisher Scientific recommends connecting the UV detector directly to the Chromeleon computer.

 **Tip:** The USB standard limits the USB cable length to 5 meters. Each USB device can be separated from the PC or next USB hub by no more than 5 meters.

The following cable is available (provided in the accessories kit for the detector):

USB Cable	Part no.
USB cable, type A to type B, high speed USB 2.0 (cable length: 5 m)	6911.0002

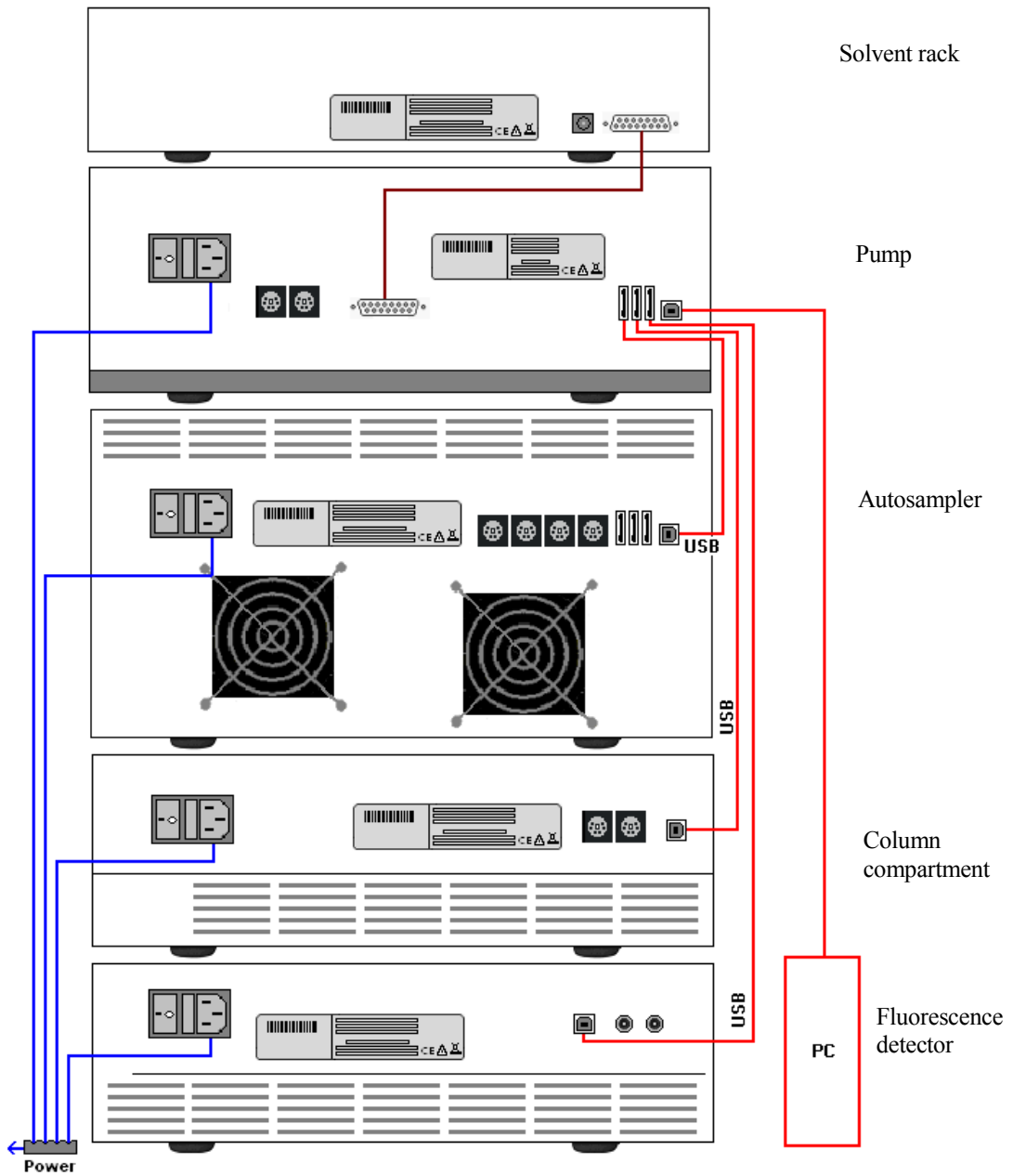

Fig. 8: Example for the rear panel connections on an UltiMate 3000 system

3.4.3 Connecting the Power Cord

Use the power cord shipped with the device to connect the detector to the main power source. No manual adjustment is required to adapt the line voltage to local voltage requirements.



Warning:

Never use a power cord other than the power cords provided for the device.

Do not use multiple sockets or extension cords. Using defective multiple sockets or extension cords may cause personal injury or damage to the device.



Avertissement: Utilisez uniquement les cordons d'alimentation électrique spécifique à l'instrument.

N'utilisez pas des blocs multiprise ou des câbles prolongateurs. Cela pourrait entraîner des blessures corporelles ou endommager l'instrument.

3.4.4 Connecting the Analog Outputs (Optional)

3.4.4.1 Installing the DAC Board

1. Turn off the detector and disconnect the power cord from its source.
2. Use appropriate grounding protection to avoid electrostatic discharge, which may result in damage to electronic components.
3. Loosen the four screws indicated in Fig. 9 and remove the access panel from the rear panel.

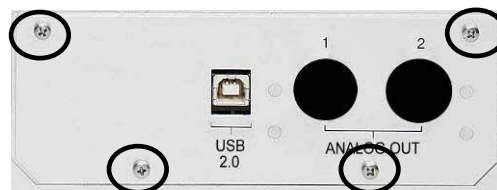

Fig. 9: Screws on the access panel

- Slide the left guide bar of the DAC board onto the green edge next to the USB port.



Fig. 10: Installing the DAC board

- Push the board partially into the enclosure. Apply slight pressure between the two analog outputs to push the board further into the enclosure until it locks into position.
- Attach the board to the rear panel, by using the 4 screws as shown in Fig. 9.
- Connect the analog outputs to an evaluation device (→ page 35).

i **Tip:** Installation of the DAC board does not require additional validation, such as Operational Qualification or Performance Qualification.

3.4.4.2 Connecting an Analog Output to an Evaluation Device

- Locate the analog output cable (part no. 6074.0002) provided with the DAC board. Plug the cable connector into the analog output on the detector rear panel.
- Connect the free end of the cable to the analog input on the evaluation device.
- Make the required settings in Chromeleon (→ section 3.4.4.3).

3.4.4.3 Configuring the Analog Outputs

Make the required settings for the analog outputs in Chromeleon.

1. On the **Detector** page in the **Properties** dialog of the detector, verify that the **DAC Board** check box is selected (→ page 42). When the check box is cleared, the analog outputs will not be available in Chromeleon.
2. Open the **Commands** dialog box for the detector.
3. Make the required settings.

Analog Output Setting	Description
Analog1_Channel Analog2_Channel	Sets the signal that is available at the analog output.
Analog1_Offset Analog2_Offset	Adjusts the zero position of the analog output when it is plotted. The value entered is a percentage of the full-scale analog output. The offset allows the evaluation device to plot the signal if it becomes negative. Even with a very small, positive analog output signal an offset of 5 %, for example, should be set, because the minimum output voltage of the analog output cannot be exactly 0 V.
Analog1_Range Analog2_Range	Sets the value range, and thus the resolution of the analog output signal. The range to use depends on the values expected for the application and the evaluation device to which the output is connected.
Analog1_Voltage Analog2_Voltage	Sets the maximum voltage value of the analog output signal (1 or 10). The range to be used depends on the input voltage of the evaluation device to which the output is connected.

3.5 Setting Up the Detector in Chromeleon

This section provides brief instructions for setting up the detector in Chromeleon. For details, see the Chromeleon Help.

-  **Tip:** When the detector is connected to the Chromeleon computer, verify that the Chromeleon software is installed before turning on the detector power for the first time. Only then, the USB driver for the detector is automatically loaded and the Windows operating system detects the detector when the power is turned on.

3.5.1 Loading the USB Driver for the Detector

1. Turn on the computer power, if it is not already on.
2. Under Windows Vista[®] (Windows[®] XP, Windows[®] 7, or Windows[®] Server 2008) log on as a
 - Local administrator if the computer is a local computer.
 - User with local computer administrator privileges if the computer is a network computer.
3. Open the **Chromeleon Server Monitor** program by double-clicking the Chromeleon Server Monitor icon  on the Windows taskbar.

If the Server Monitor icon is not on the taskbar, click **Start** on the taskbar, point to **Programs** (or **All Programs**, depending on the operating system), point to **Chromeleon**, and then click **Server Monitor**.

4. Click **Start** to start the server.
5. Click **Close** to close the Server Monitor window. The Server Monitor icon  appears on the taskbar.

-  **Tip:** Clicking the **Quit Monitor** button quits (exits) the **Server Monitor** program, but does not stop the server. To stop the server, click **Stop**.
6. Turn on the main power switch on the rear panel of the detector.

7. *Windows Vista, Windows 7, and Windows Server 2008*

will automatically detect the new detector and perform the USB installation.

If Windows fails to detect the detector and launches a wizard instead, this indicates that you connected the detector to the computer and turned on the power for the first time before you installed Chromeleon. To resolve the problem:

- a) Click **Cancel** to exit the wizard.
- b) Turn off the detector.
- c) Install Chromeleon.
- d) Turn on the detector power. Windows will now detect the detector and install the USB software for the detector automatically.

Windows XP

will automatically detect the new detector and launch the **Found New Hardware Wizard**, which guides you through the USB installation. Select the following options:

- a) If asked whether Windows can connect to Windows Update to search for software, select **No, not this time**.
- b) Accept the default option (**Install the software automatically**) and click **Next>**.
- c) Click **Finish** when the wizard reports that the software for the detector has been installed.

If Windows XP fails to detect the detector and a message box asks for a USB configuration file (cmwdmusb.inf), this indicates that you connected the detector to the computer and turned on the power for the first time before you installed Chromeleon. To resolve the problem:

- a) Click **Cancel** in the Windows message box.
- b) Turn off the detector.
- c) Install Chromeleon.
- d) Turn on the detector power. Windows will now automatically detect the detector and launch the **Found New Hardware Wizard**.

3.5.2 Installing the Detector

After the USB software for the detector has been installed (→ page 37), install and configure the detector in Chromeleon:

1. Start the Chromeleon **Server Monitor** (→ page 37) and the Chromeleon server if they are not yet running.
2. Start the Chromeleon **Server Configuration** program by clicking **Start** on the taskbar. Point to **Programs** (or **All Programs**, depending on the operating system), point to **Chromeleon**, and then click **Server Configuration**.
3. If necessary, click the plus sign next to the server name to display the items underneath.
4. Select the timebase to which the detector will be assigned, or create a new timebase (on the **Edit** menu, click **Add Timebase**).
5. Open the **Add device to timebase** dialog box. To do so, click **Add Device** on the **Edit** menu or right-click the timebase and click **Add Device** on the menu.
6. On the **Manufacturers** list, click **Dionex HPLC: UltiMate 3000** and on the **Devices** list, click **FLD-3x00(RS) Detector**.
7. The configuration pages are opened. On each page, verify that the settings are correct and select additional settings if needed. For a description of the pages, see section 3.5.3.1.
8. Click **OK** to complete the configuration of the detector.
9. On the **File** menu, click **Save Installation** and then close the Server Configuration program.

3.5.3 Configuring the Detector

3.5.3.1 Initial Installation

During the installation, Chromeleon connects to the detector and transfers the settings from the instrument firmware to Chromeleon, setting the options on the wizard pages accordingly. Verify that the settings are correct and make additional settings if needed. You may reopen the configuration pages later again to change the settings (→ page 43).

i **Tip:** Changing the settings for a specific application in the **Commands** dialog box, in a program file (PGM), or on a control panel will not change the default settings on the configuration pages.

For additional information about a page, click **Help**.

General Page

Shows the general instrument parameters.

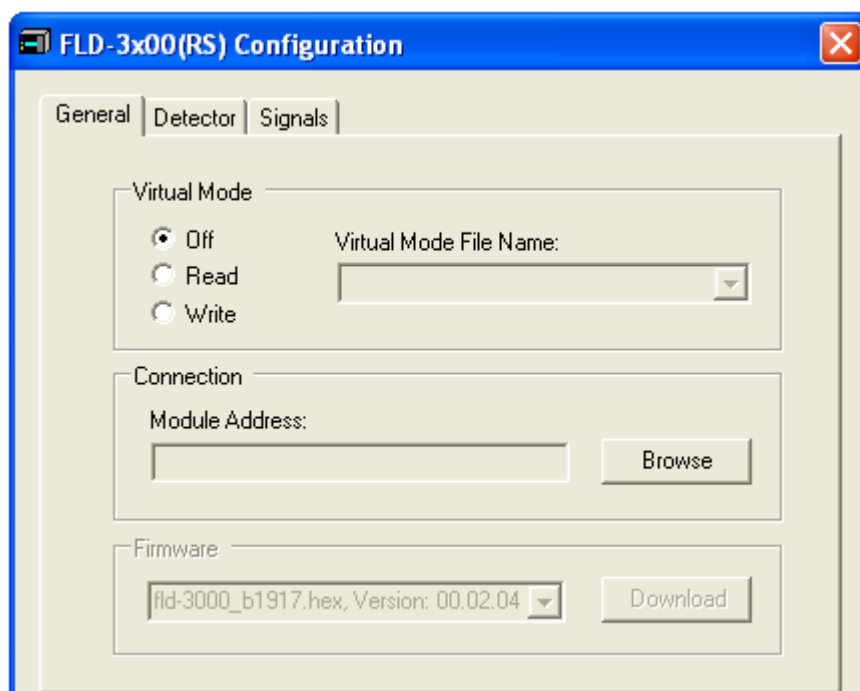

Fig. 11: General page

- **Virtual Mode**

Verify that the virtual mode is set to off. If the virtual mode is enabled, the **Module Address** box will be unavailable. If you exit this page without having entered a module address, the virtual mode will be enabled automatically.

In the virtual mode, Chromeleon simulates detector control and data acquisition.

- ◆ Click **Read** to read and display data from an existing demo file instead of real data. Select the file from the **Virtual Mode File Name** list.

- ◆ Click **Write** to save the data currently delivered by the detector as a demo file. Enter the file name in the **Virtual Mode File Name** field or select a name from the list.

- ❏ **Tip:** When recording virtual mode files in Chromeleon 6.80, the size of the file is limited to 35MB. This corresponds to about 9 minutes at a data collection rate of 100 Hz. If you want to record longer virtual mode files, reduce the data collection rate.

- **Module Address**
Select the module address of the detector. Click **Browse** and then double-click the detector that you want to use on the **Device List**. The address is automatically entered in the **Module Address** field. Chromeleon connects to the detector and transfers the settings from the instrument firmware to Chromeleon, setting the options on the pages accordingly. Confirm the related message with **OK**.

- **Download**
Click this button to transfer the current detector configuration to Chromeleon. (The button appears dimmed if the virtual mode is enabled.)

The detector is shipped with the most recent firmware version. If a firmware update is ever required, follow the steps in section 7.6 (→ page 115).

Detector Page

The Detector page shows the detector configuration.

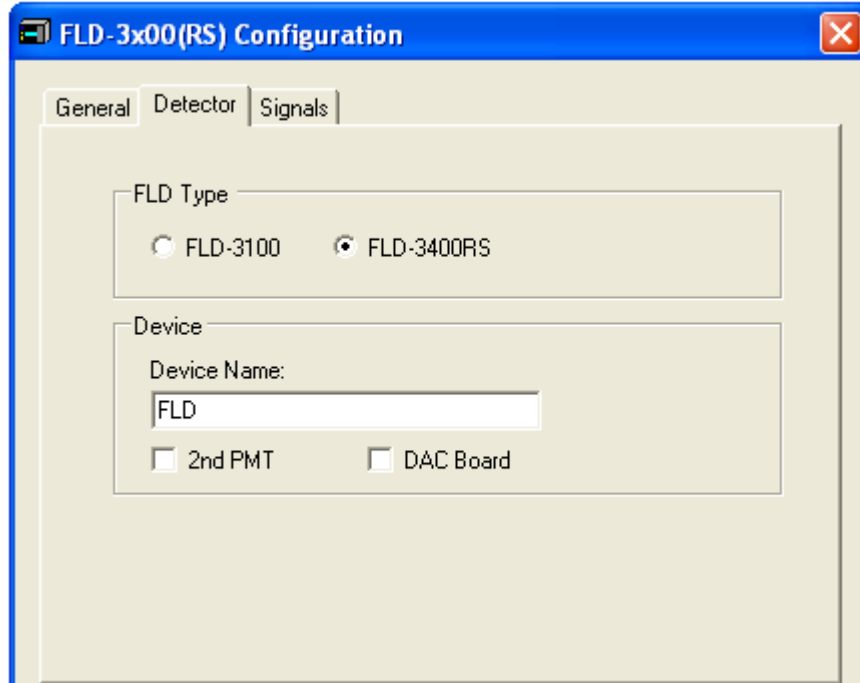

Fig. 12: Detector page

- **FLD Type**
Select the detector type. Make sure that the selected option corresponds to the actually installed detector type.
- **Device Name**
Displays the name used to identify the detector the installation environment and in the Chromeleon client program. To control the detector with the existing control panels, accept the default name. If you enter a different name, you may have to re-link the controls on the control panels and edit the device name in the program files.
- **2nd PMT**
This check box must be selected if the optional red-sensitive Dual-PMT option for measuring wavelengths up to 900 nm is installed.
- **DAC Board**
This check box must be selected if optional analog output are installed. (→ page 34)

Signals Page

The page lists all signal channels that the detector can record. A name is defined for each channel. To allow raw data collection for a channel, select the **Enabled** check box next to the channel name. If the check box is cleared, the detector cannot collect raw data for the channel. To change a name, click in the field and overwrite the existing name directly in the field.

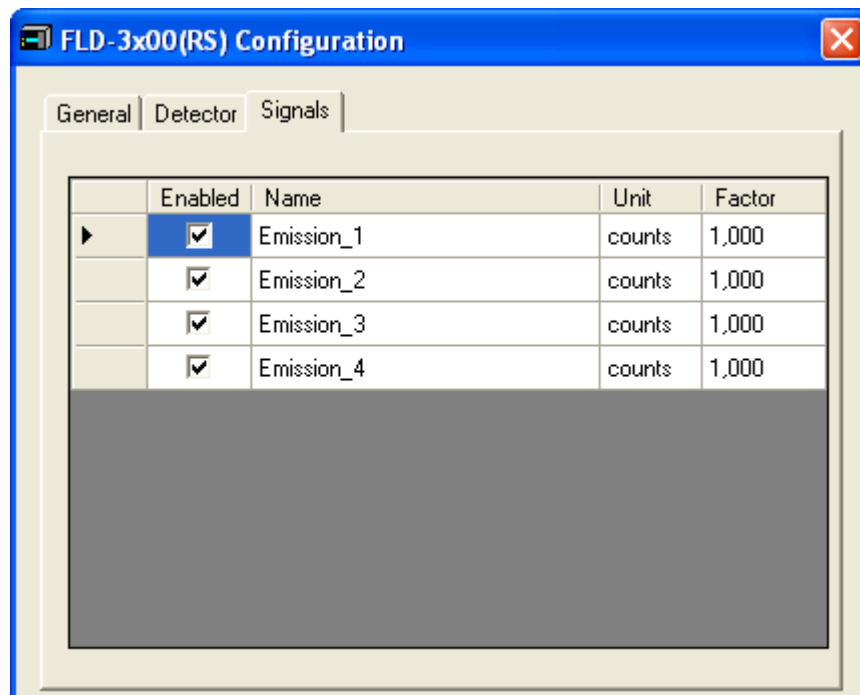

Fig. 13: Signals page (here: FLD-3400RS)

3.5.3.2 Changing the Configuration Properties

You may reopen the configuration pages later again to change the settings.

1. Start the **Server Configuration** program (→ page 39).
2. Right-click **FLD-3x00(RS) Detector** in the timebase and click **Properties** on the menu.
3. Change the settings as needed. For a description of the pages, see section 3.5.3.1 (→ page 40).
4. To save the changed configuration, click **Save** on the **File** menu and then close the **Server Configuration** program.

3.6 Setting Up the Detector in DCMSLink

To set up the detector in DCMSLink, refer to *DCMSLink Installation Guide*, which is provided on the DCMSLink DVD in the *Additional Documents\DCMSLink User Documents* folder.

1. Install and configure the DCMSLink software (→ *DCMSLink Installation Guide*).
2. Open the Chromeleon **Server Configuration** program (→ *DCMSLink Installation Guide*).
3. In the **Server Configuration** program, add the detector to the timebase. The steps in section 3.5.2 apply equally (→ page 39).
4. Configure the detector. The steps in section 3.5.3 apply equally (→ page 40).

For more information about DCMSLink, refer to the *DCMSLink Quick Start Guide*, which is also provided on the DCMSLink DVD and to *DCMSLink Help*.

4 Preparation for Operation (Startup)

4.1 Overview

After you have unpacked, positioned and connected the detector as described in sections 3.1 through 3.5 (→ page 29 and following), prepare the detector for operation. Follow the sequence of steps below:

1. No flow cell is installed when the detector is shipped. Install a flow cell (→ page 110) and connect the cell inlet connection to the separator column outlet. Connect a waste capillary to the flow cell outlet.
2. Connect the drain tubing (→ page 47).
3. Set up the detector in Chromeleon if it is not already set up (→ page 37).
4. Check and change the leak sensor setting if necessary (→ page 72).
5. Adjust the brightness and contrast of the detector display if necessary (→ page 72).
6. *If you want to connect additional evaluation devices to the detector*
Install the DAC plug-in board and configure the analog outputs (→ page 34).
7. Before using the module for sample analysis, equilibrate the entire system (→ page 51).

4.2 General Precautions for Connecting Capillaries

When connecting capillaries, observe the following general precautions:

- Observe the precautionary statements for capillaries and capillary connections in section 1.2.2 (→ page 5).
- UltiMate 3000 systems with stainless steel fluidics are shipped with Viper capillary kits. The kits include a Viper capillary for connecting the detector to the separation column when the system includes only one detector. For UltiMate 3000 RSLC systems, you can use the post column cooler to connect the detector to the column as an alternative. This is recommended if you are operating the column at temperatures above 60°C, as high temperatures may reduce the intensity of the fluorescence signal.
- If you are using more than one detector in a system, for example, a UV detector and a fluorescence detector, another Viper capillary is available in the flow cell accessories.
- If possible, use a Viper capillary between the column and the detector. In rare cases, this may not be possible for columns from third-party manufacturers. Always make sure that the ID of replacement capillary corresponds to the ID of the capillary shipped with the system.
- Depending on the fitting connection, also observe the following:

- ◆ *Viper fitting connections*

Loosen or tighten the Viper connection only using the black knurled screw and only with your hand (do not use tools). The knurled screw can be easily removed and reattached to the capillary at any time. Viper capillaries are designed to be leak-free for all pressures that arise in UltiMate 3000 systems simply by tightening them with your hand. If you observe leakage on the connection, tighten the screw a little further. If leakage continues, remove the capillary, clean the capillary ends carefully by using a cloth or tissue wetted with isopropanol, and reinstall the capillary. If the connection continues to leak, replace the Viper capillary.

When connecting the Viper capillary to the flow cell inlet, observe the guidelines in the Installation Instructions shipped with the capillary.

Capillaries with Viper fitting connections can be reused also for a different connection.

◆ *Conventional fitting connections (non-Viper)*

Do not over-tighten these fitting connections. If you observe leakage on the connection, tighten a little further.

If leakage still exists, first consider cleaning the connection port with a cleaning swab (part no. 6040.0006). Replace the capillary and/or fitting if this does not eliminate the problem.

Reuse used fittings and ferrules only for the same capillary connection. This is to avoid increased dead volume or damage to the system and leakage

4.3 Connecting the Drain System

To discharge liquid leaks and waste, the detector has a drain port at the bottom right of the instrument.

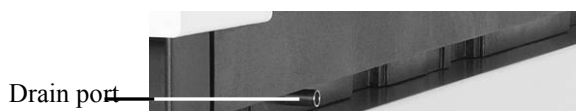

Fig. 14: Drain port

Direct liquid leaks to waste via the drain system of the UltiMate 3000 system, using the components from the drain kit. The kit is shipped with the UltiMate 3000 pumps and can be ordered separately (part no. 6040.0005). The kit includes all required components and detailed installation instructions. If there is more than one detector in your system and you need an additional tee piece, you can find one in the accessories kit of the fluorescence, multiple wavelength, or diode array detector.

4.4 Installing the Flow Cell

Observe the following when installing a flow cell:

- Always hold flow cells by the flow cell body with the type label. Do not touch the optical block of the flow cell (→ Fig. 15) or the sensitive electronics on the flow cell rear side.

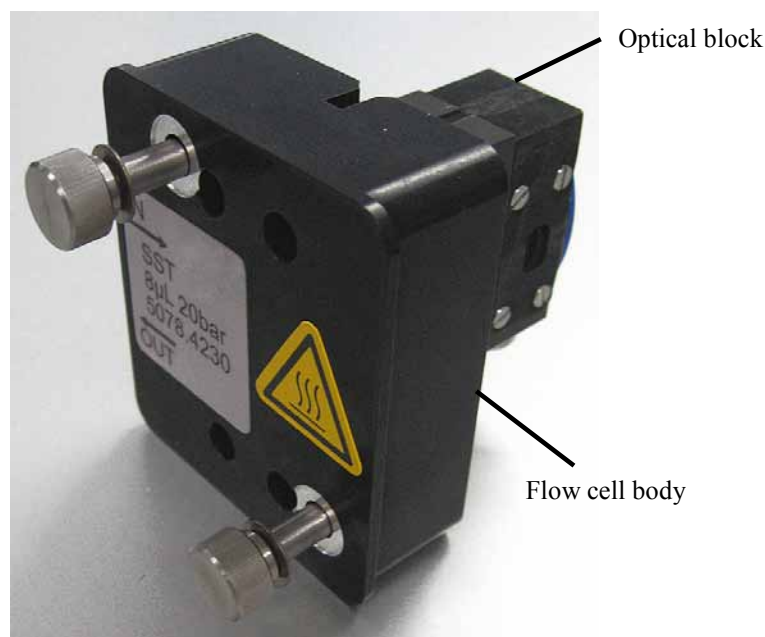

Fig. 15: Flow cell of the fluorescence detector

- A cover is mounted on the flow cell opening when the detector is shipped. Keep this cover in a safe place. If the detector is shipped or shut down for a longer time period, reinstall the cover.
- Plugs are installed at the flow cell in and out connections (→ Fig. 19). Keep the plugs in a safe place. If the detector or the cell is shipped or if the detector is shut down for a longer time period, reinstall the plugs.
- Capillary connections between the column and flow cell should be as short as possible to avoid peak broadening effects due to excessive dead volume.
- When connecting the flow cells, make sure not to invert input and output. This will deteriorate the measured results and may destroy the flow cell due to the increased backpressure in the cell.

- The backpressure on the flow cell must not exceed 20 bar (analytical flow cell) or 40 bar (micro flow cell). Do not connect any capillaries or instruments to the flow cell out line as this might generate a higher backpressure. Even if the pressure exceeds the upper limit for a very short time only, the flow cell may be permanently damaged. If it is required to connect a valve at the flow cell outlet, the valve may only be switched while the flow is stopped. When switching valves while the flow is turned on, pressure peaks may occur and destroy the flow cell. Thermo Fisher Scientific recommends using a capillary or tube with an internal diameter of at least 0.5 mm at the flow cell out line.

Installing the Flow Cell

1. Remove the cover on the flow cell opening (if installed). To do so, loosen the two finger-tight screws. No tools are required to loosen the screws. The screws are captive in the cover and do not need to be removed.

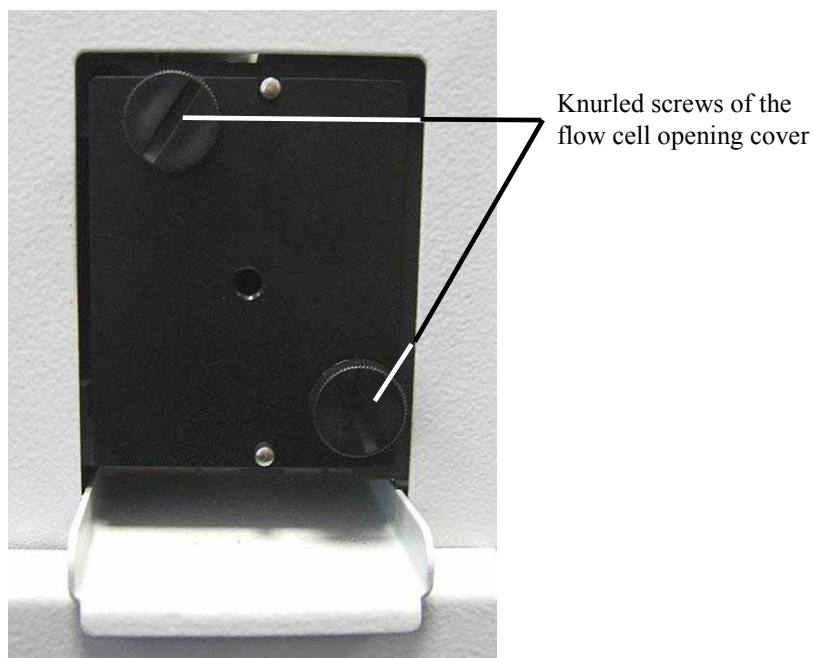

Fig. 16: Removing the cover

2. Insert the flow cell straight into the cell opening.



Fig. 17: Inserting the flow cell

3. Tighten the flow cell screws hand-tight.

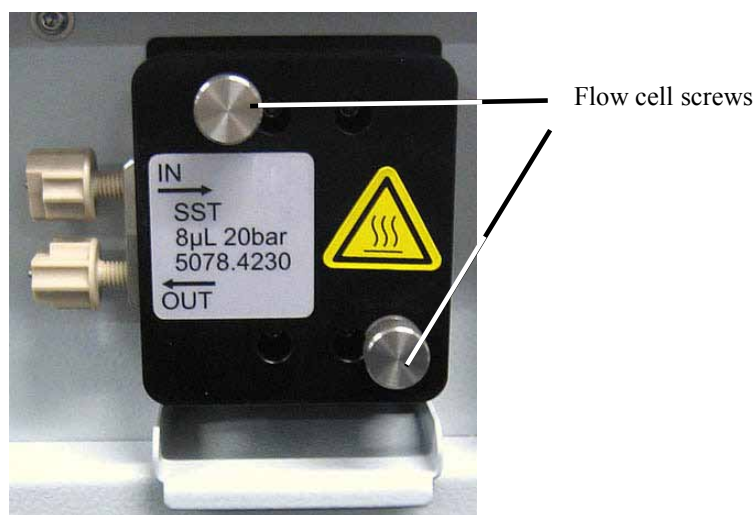

Fig. 18: Tighten the flow cell screws

4. Remove the dummy plugs at the flow cell in and out connection ports. Connect the flow cell inlet to the separation column. Connect the PEEK capillary from the accessories kit for the detector as waste capillary to the flow cell outlet. Extend the PEEK capillary with the silicone tubing (also included in the accessories kit for the detector). Route the capillaries to the outside through the slots provided in the detector enclosure to prevent them from being pinched when the front panel door is opened.
5. Close the front panel door to allow the firmware to detect the new flow cell.
6. Perform a wavelength calibration (→ page 90).

4.5 Equilibrating the System

Before using the detector for sample analysis, equilibrate the UltiMate 3000 system:

1. Pump the starting solvent through the entire system until the system is free of any other liquid composition.
2. Heat or cool all temperature-controlled devices, such as the column oven, to the temperature required for the application.
3. Heat the flow cell of the fluorescence detector to the required temperature.
4. *If a UV detector is installed:* Set the detector wavelengths and turn on the lamp.
5. Monitor the pump pressure. Verify that the reading is correct for the application and is stable.
6. Monitor the UV detector signal and verify that the baseline signal is at the expected reading for your application and is stable.

Perform system equilibration in Chromeleon or select the required commands and parameters on the front panel menus of the instruments.

To equilibrate the system from Chromeleon

- Select and perform the operating commands and parameters from the **Commands** dialog box.
- Create and run an equilibration program to automate the process (→ page 67).
- Use the SmartStartup Wizard to create and run the equilibration program (see the next section).

To create the equilibration program with the SmartStartup Wizard

1. To open the wizard, select **SmartStartup** on the **Batch** menu.
2. Follow the instructions as they appear on each page of the wizard. For additional information about a page, click **Help**.
3. After you finish the wizard, Chromeleon
 - ◆ Generates an equilibration program and sequence.
 - ◆ Opens the equilibration control panel for the instruments in the timebase.
 - ◆ Opens the **Start Batch on** dialog box.

Click **Start** to begin equilibration.

The equilibration panel shows the equilibration status of each instrument in the system.

4.6 General Guidelines for Detector Operation

The following sections offer general guidelines for detector operation. For information about how to optimize the detector performance, see section 5.7 (→ page 77).

4.6.1 Mobile Phases

Mobile phase quality significantly affects detection limits and instrument performance. To ensure optimal performance of the detector, observe the following guidelines:

- Prepare all mobile phases with HPLC-grade (or better) solvents, reagent-grade chemicals, and filter HPLC-grade water. Usually, HPLG-grade solvents will provide good results. As impurities in the solvents increase the baseline noise, you should use special fluorescence-grade solvents, for example LiChrosolv[®], for sensitive applications. Always use fluorescence-grade solvents and water for Raman tests and instrument qualification.
- Degas all mobile phases before use and maintain them in a degassed state.
- Strong bases can etch the silica windows of the flow cell. Therefore, avoid the use of mobile phases with a pH value > 9.5. In any case, disconnect the separation column and flush the system with HPLC-grade water for 5°minutes at 1.0°mL/min immediately after the analysis when alkaline solutions are used.
- Mobile phase pH affects not only the retention time of the separation, but the fluorescence intensity and wavelength of the sample.
- When changing from a buffer to a different operating mobile phase, be sure the solvents are miscible and will not induce precipitation of the buffers. Flush the cell with a buffer-compatible solvent (in most cases, HPLC-grade water) immediately after the analysis. Do not allow buffers to remain in the cell for extended periods.

For information about the properties of common used mobile phases, see section 10 in Table 1 (→ page 123).

4.6.2 Mobile Phase Delivery System

The pumping system should deliver continuous flow while ensuring intermixing of the mobile phase (if gradient elution is used). Fluctuations in pump backpressure can cause baseline noise. If the noise is synchronized with the pump stroke, check your HPLC pump.

The plastics present in some solvent delivery systems from third-party manufacturers are not fully compatible with the solvents commonly used in chromatography. Therefore, plastic components may dissolve, and thus impair fluorescence detection.

For UV wavelengths, these guidelines are recommended:

- The mobile phase reservoir should be glass.
- All tubing connections should be made of materials suitable for HPLC applications (for example, PTFE, ETFE, PEEK, stainless steel, or titanium), as required for the operating pressures and application.
- Some pump seals incorporate a band spring to preload the seal during the vacuum stroke of the piston. The band spring should be made of stainless steel, a fluoropolymer (perfluoroelastomer or fluorosilicone), or another material of known quality.

If you are working with an UltiMate 3000 system, using original Dionex parts only, all the above recommendations are met.

4.6.3 Flow Cells

To ensure optimum performance of the flow cells, observe the following guidelines:

- The backpressure on the flow cell must not exceed 20 bar (analytical flow cell) or 40 bar (micro flow cell). Do not connect any capillaries or instruments to the flow cell out line as this might generate a higher backpressure. Even if the pressure exceeds the upper limit for a very short time only, the flow cell may be permanently damaged. If it is required to connect a valve at the flow cell outlet, the valve may only be switched while the flow is stopped. When switching valves while the flow is turned on, pressure peaks may occur and destroy the flow cell. Thermo Fisher Scientific recommends using a capillary or tube with an internal diameter of at least 0.5 mm at the flow cell out line.
- When connecting the flow cells, make sure not to invert input and output. This will deteriorate the measured results and may destroy the flow cell due to the increased backpressure in the cell.
- The contacts for the flow cell identification chip and the temperature control are located on the rear of the flow cell. To ensure proper functionality, be careful not to touch the sensitive electronics. If liquid comes into contact with the electronics, dry it immediately.

- The flow cells are sensitive to dirt and dust. Therefore:
 - ◆ Always keep unused flow cells in their original dust-free packaging.
 - ◆ Always hold flow cells by the flow cell body with the type label. Do not touch the optical block of the flow cell (→ Fig. 15, page 48).
 - ◆ Even during periods of detector inactivity, a flow cell or the cover shipped with the detector must be installed. This is to prevent dust particles from causing damage to the detector optics.
 - ◆ When shipping the instrument, *remove* the flow cell and install the special cover to protect the flow cell opening. Close the flow cell inlet and outlet with the plugs that were installed when the flow cell was shipped (→ Fig. 19). The flow cell must be shipped in its original packaging.

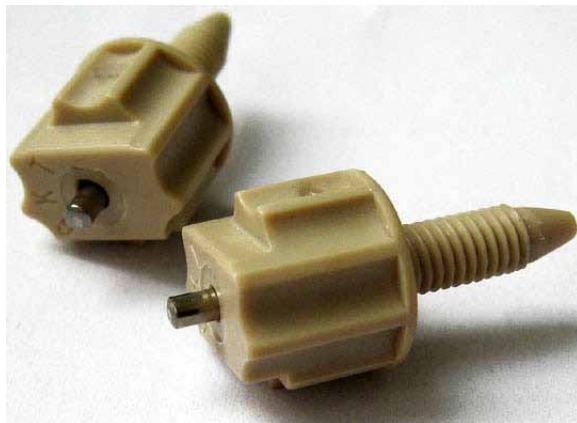

Fig. 19: Original Dionex flow cell plugs

- During longer idle times, the flow cell should not be filled with pure water to avoid the growth of algae. Add 10% HPLC-grade isopropyl alcohol, for example, and plug the flow cell input and output using the plugs that were installed when the flow cell was shipped (→ Fig. 19). Using different plugs and tightening them may destroy the flow cell.
- If a flow cell leaks, remove the flow cell from the detector as quickly as possible, and replace the flow cell.
- For information about how to clean a flow cell, see page 109.

5 Operation and Maintenance

The detector can be controlled by the Chromeleon Chromatography Management System. For details, see section 5.4 (→ page 64) and the following.

5.1 Power-Up

To start the detector for the first time, turn on the main power switch on the rear panel of the detector. The following sequence of events occurs when the detector is powered up

- For a short time, general information about the detector appears on the display: device type, firmware version, and serial number.
- The detector runs a series of internal tests. (The test takes about 30 seconds.) During these self-diagnostics, all of the main components are checked. When the self test was successful, the initial screen changes to the status screen (→ page 55).
- If an error is detected, the detector is not ready for analysis. The **Status** LED on the front panel is red and a message appears on the front panel display. If the detector is operated with Chromeleon, the message appears also in the Chromeleon Audit Trail. Turn off the detector, take appropriate remedial action (→ page 97), and turn on the detector again.
- If the message "Not calibrated" appears, verify that a flow cell is installed and execute the **Calibrate** command in Chromeleon.

For routine operation, leave the main power switch on. For routine on/off control, use the standby button on the front of the TCC (→ page 21). Press and hold the button for about one second to allow the detector to change the mode. Turn the main power switch off when instructed to do so, for example, before performing a service procedure.

5.2 Detector Display

When the self test was successful, the initial screen changes to the status screen.

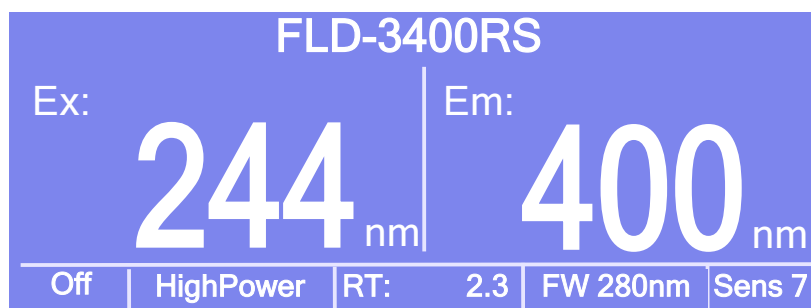

Fig. 20: Status screen (example)

You can adjust the screen brightness or screen contrast to your requirements from Chromeleon or on the detector display (→ page 72).

View the progress of data acquisition on the detector display

After data acquisition was started via Chromeleon (**AcqOn**), you can monitor the progress of data acquisition on the display. The display shows a scaled fluorescence value (in counts) at the selected wavelength. The number of measurement channels determines the appearance of the screen.

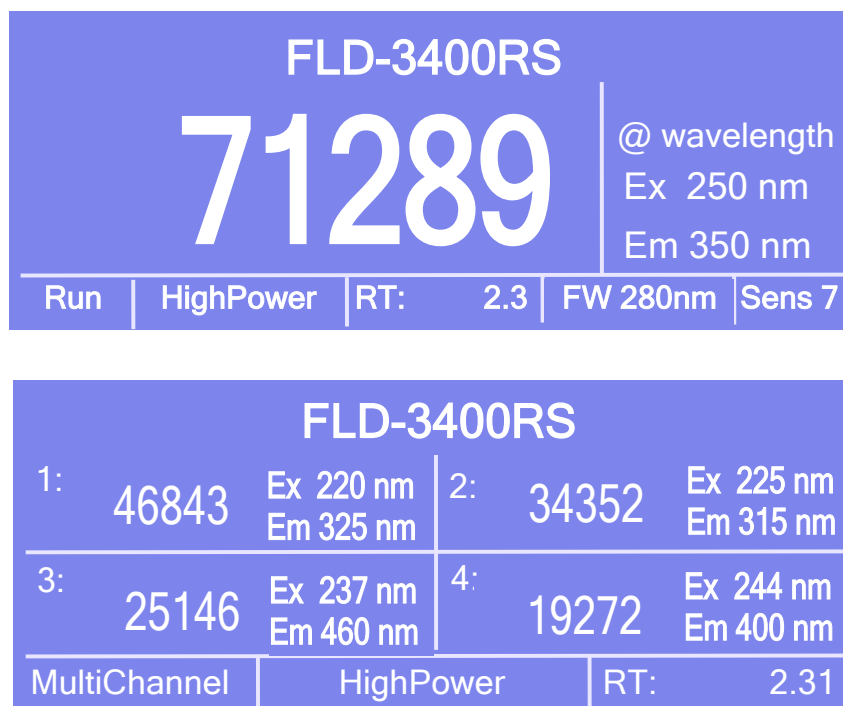

Fig. 21: Data acquisition screen (examples)

The status screen shows the following information:

- Fluorescence values
- Emission and excitation wavelength
- Operational Status
- Lamp mode
- Retention time
- Filter wheel setting and sensitivity (only in Single-Channel Mode)

5.3 Menu on the Detector Display

Via the menus that are available on the front panel display, you can make several settings or access information directly from the detector.

For information about the menus, see section 5.3.1 (→ page 58).

Showing the menu key

Four white spots can be found on the front panel below the display. To show the keys, touch the position of the utmost left spot on the display with the menu pen (part no. 6300.0100). The menu pen is included in the accessories kit for the UltiMate 3000 autosampler.



Fig. 22: Showing the menu key

The menu key replaces the information in the bottom line of the status screen. Select the utmost left spot again to call the main menu. If no key is selected, the bottom line of the status screen is restored after about 5 seconds.



Fig. 23: Menu key

If the detector is connected with Chromeleon, settings that do not interfere with the measurement, such as, the screen brightness or contrast, can still be changed from the display.

5.3.1 Detector Menus

Fig. 24 shows an overview of the detector menu. For information about the general menu layout and structure, see page 59. For information about the individual commands and parameters, see sections 5.3.3 through 5.3.5 (→ page 61 and following pages).

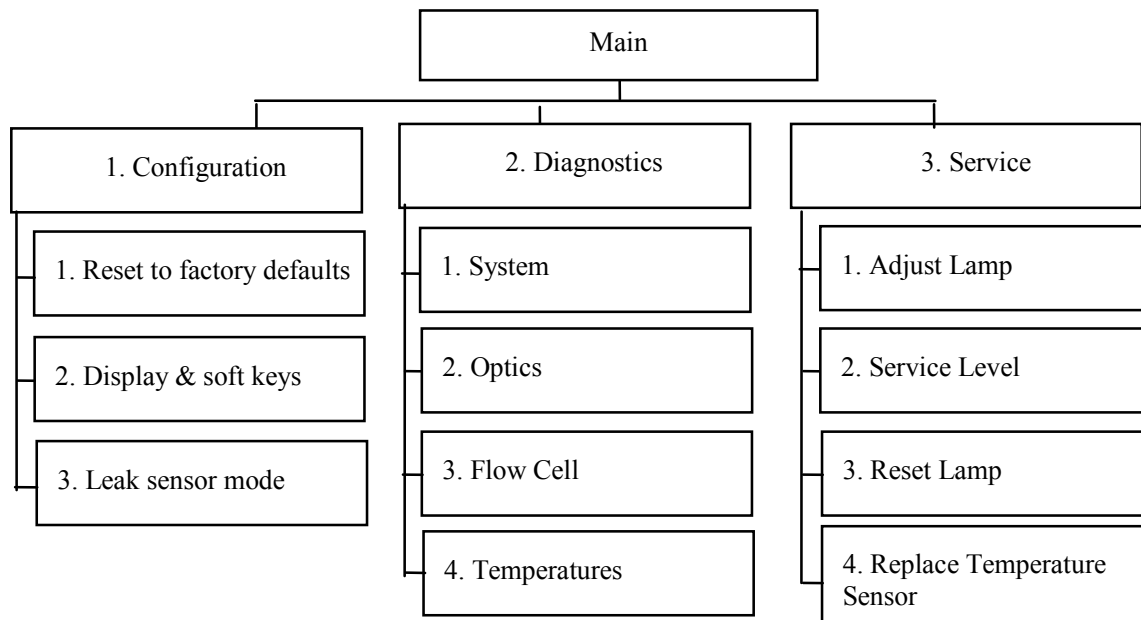

Fig. 24: Detector menu structure

5.3.2 General Menu Layout and Structure

In general, the menu layout is as follows:

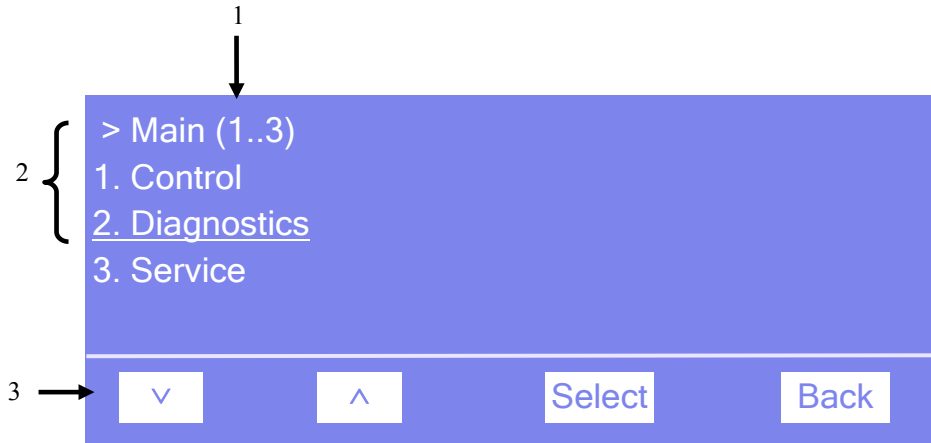

Fig. 25: Menu layout (here Main menu)

No.	Description
1	Reports the menu name and the number of items on the menu list.
2	The menu items appear on a list and are numbered consecutively. The selected item is underlined.
3	Navigation bar

Select an item with the arrow up or down key—the selected item is underlined. Confirm your selection with **Select**. **Back** returns you to the previous menu level.

The selected menu item or parameter determines which function keys appear on the navigation bar:

To ...	Select ...
Return to the previous entry on a list. If the list contains 5 or more items, you can use the arrow up key to scroll up through the list, after reaching the first line (→ Key autorepeat, page 62).	^
Increment numerical values.	^
Proceed to the next entry on a list. If the list contains 5 or more items, you can use the arrow up key to scroll up through the list, after reaching the fourth line (→ Key autorepeat, page 62).	v
Proceed to the next figure in a number. Any decimal point is skipped.	>
Confirm the selection and activate the input field if applicable. Note: If an item is read-only, the Select key will not be available.	Select
- Return to the previous menu level. - Return to the status screen (from the Main menu).	Back

To ...	Select ...
Toggle between two operating states (for example, between Silent and Audible in the Leak sensor mode).	Toggle
Confirm the selection and perform the action. For example, if you change the brightness of the display, you have to select OK to confirm the change.	OK.
Cancel the action and restore the last value. For example, if you have changed the brightness of the display, select Cancel to undo this action and to restore the previous operating state.	Cancel
Note: Depending on the selected option, specific keys may replace these general keys.	

If an error is found, one or more messages appear on the front panel display. In this case, the **Prev**, **Next**, and **Clear** keys appear on the navigation bar.

To ...	Select ...
Return to the previous message.	Prev
Proceed to the next message.	Next
Remove a message from the display.	Clear

5.3.3 Main Menu

The **Main** menu provides top-level access to the menu structure. To open the **Main** menu, show the function keys and select **Menu** (→ page 57).

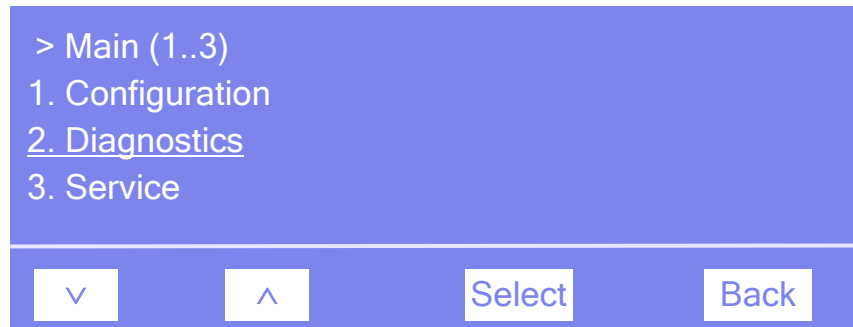

Fig. 26: Main menu

Select an item with the arrow up or down key—the selected item is underlined. Confirm your selection with **Select**. **Back** returns you to the status screen.

For information about the menus, see

- Configuration Menu (→ page 61)
- Diagnostics Menu (→ page 63)
- Service Menu (→ page 63)

5.3.4 Configuration Menu

The **Configuration** menu provides information about the detector configuration and allows you to make the required settings or change the settings.

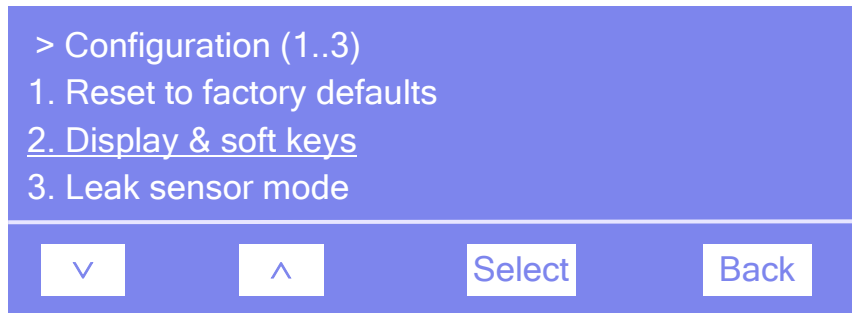

Fig. 27: Configuration menu

To ...	Select ...
Reset all important detector settings to the standard settings. In the Reset to factory defaults? dialog box, select OK to confirm the restore or select Cancel to keep your settings.	Reset to factory defaults
Set the display and function key parameters: Brightness —sets the screen brightness. Contrast —sets the screen contrast. Key sound —sets whether a beep sounds when you select a function key: On —yes or Off —no. Key autorepeat —sets whether the keystroke is automatically repeated when you remain on the key for a longer period, for example, to change a value quickly (On = yes or Off = no).	Display & soft keys
Set how you are alerted in case of a leak alarm: Audible —activates the leak alarm. When a leak is detected, a beep sounds. Silent —deactivates the leak alarm. When a leak is detected, a message appears on the front panel display, but no beep sounds.	Leak Sensor Mode

5.3.5 Diagnostics Menu

The **Diagnostics** menu provides information for diagnostics purposes (read-only).

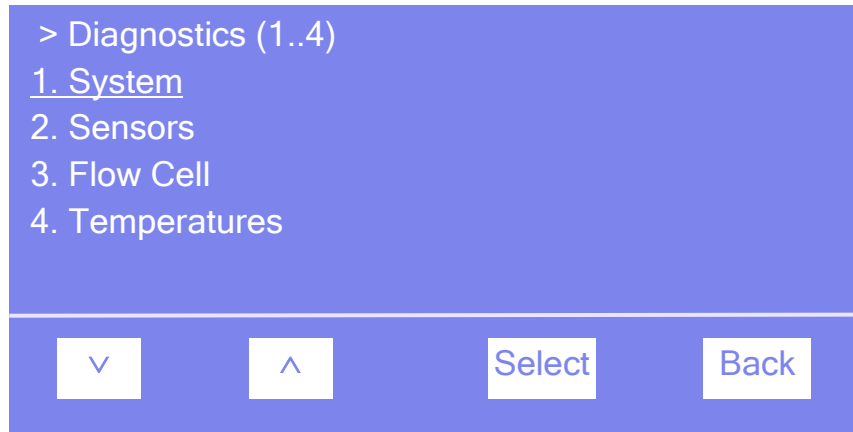

Fig. 28: Diagnostics menu

You can see the following information (all information is read-only):

To ...	Select ...
View information about the detector, such as detector type and firmware version.	System
Check whether a second, red-sensitive PMT is installed.	Optics
View information about the flow cell, such as, serial number, flow cell type, and flow cell material.	Flow Cell
View information about the temperatures inside the detector	Temperatures

5.3.6 Service Menu

The **Service** menu provides information for authorized service personnel when exchanging certain components.

5.4 Operation with Chromeleon

Before you begin, verify that

1. The Chromeleon software is installed on the computer and the license code is entered.
2. The detector is connected to the Chromeleon computer via a USB connection.

i **Tip:** Verify that Chromeleon is installed on the computer and that the license code is entered *before* you connect the detector to the USB port on the Chromeleon computer and turn on the detector power. Only then, the USB driver for the detector is automatically loaded and the Windows operating system can detect the detector when the power is turned on.

3. The detector is set up in Chromeleon, as described in section 3.5 (→ page 37).

Before you can operate the detector with Chromeleon, you have to connect the timebase in which the detector is installed to the Chromeleon client program (→ page 64).

Two modes of software control are available:

- **Direct control** with the parameters and commands from the **Commands** dialog box (→ page 65) or from a control panel (→ page 66).
- **Automated control** with a control program (PGM) (→ page 67).

5.4.1 Connecting to Chromeleon

1. Start the Chromeleon **Server Monitor** and the Chromeleon server if they are not yet running (→ page 37).
2. Start the Chromeleon client by clicking the Chromeleon icon  on the desktop. If the Chromeleon icon is not on the desktop, click Start on the taskbar, point to Programs (or **All Programs**, depending on the operating system), point to Chromeleon, and then click **Chromeleon**.
3. Connect the Chromeleon client program to the timebase in which the detector is installed. For details about how to do this from the **Commands** dialog box, see page 65. For details about how to do this on a control panel, see page 66.

When the detector is correctly connected to Chromeleon

- The **Connected** LED on the front panel is green.
- Front panel input related to the measurement is disabled.
- Functions for estimating the lifetime of consumables and monitoring and recording service and (re)qualification information are provided (→ page 87).
- The **Standby** button on the front panel remains active.

Before turning off the detector by the main power switch, always **disconnect** the module in Chromeleon.

5.4.2 Direct Control

With direct control, you select operating parameters and commands in the Commands (F8) dialog box. Direct commands are executed as soon as they are entered. For routine operation, most parameters and commands are available also on a control panel.

 **Tip:** Manual acquisition from the **Commands** dialog box is only supported for one channel. The Multi-Channel Mode is not available.

To open the Commands dialog box for the detector

1. Open a control panel (any panel is possible). To open a control panel, open the Chromeleon Browser and double-click a control panel in the **Dionex Templates/Panels** folder.
2. Connect the control panel to the timebase in which the detector is installed. On the **Control** menu, select **Connect to Timebase**, and then select the timebase on the **Timebase** tab. (The Control menu is visible only when a control panel is open.) For information about the **Timebase** dialog, click **Help**.
3. Press the F8 key or select **Command** on the **Control** menu.
4. To see the parameters and commands that are available for the detector, click the plus sign next to **FLD**.

The commands and parameters available in the dialog box vary, depending on the

- ◆ Chromeleon version
- ◆ Options selected for the detector in the Properties dialog (→ page 40).
- ◆ Display filter level (**Normal**, **Advanced**, or **Expert**)

5. Change the display filter level if necessary. Right-click in the commands list and select the filter level on the menu.

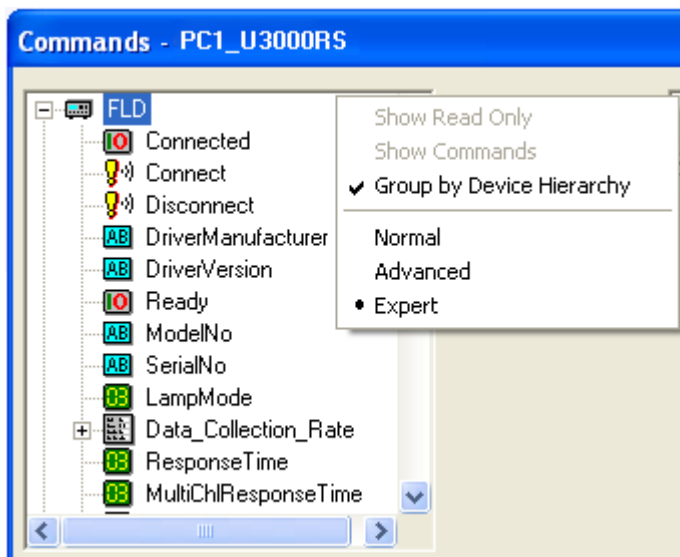

Fig. 29: Commands dialog box

6. Verify that the detector is connected to Chromeleon. If it is not, select **Connect** to connect the detector.

For a list of the commands and properties that are supported for the detector, see the Chromeleon Help. In addition to the detector commands and parameters, the **Commands** dialog box provides access to all of the commands and parameters available for all devices that are installed in the selected timebase.

To open a control panel

1. On the **View** menu, click **Default Panel Tabset** or click the corresponding icon on the toolbar , and then connect to the Chromeleon server.

Chromeleon creates centralized control panels, called panel tabsets, for all timebases available on the Chromeleon server. A panel tabset provides control panels for the individual instruments in a timebase and, in addition, one or more panels for performing system-wide functions, for example, creating and running sequences. For more information about panel tabsets, see the Chromeleon Help.

2. On the Panel Tabset for your timebase, click the page for the detector.

- Verify that the detector is connected to Chromeleon (the LED next to the Connect button is green). If it is not, click **Connect**.

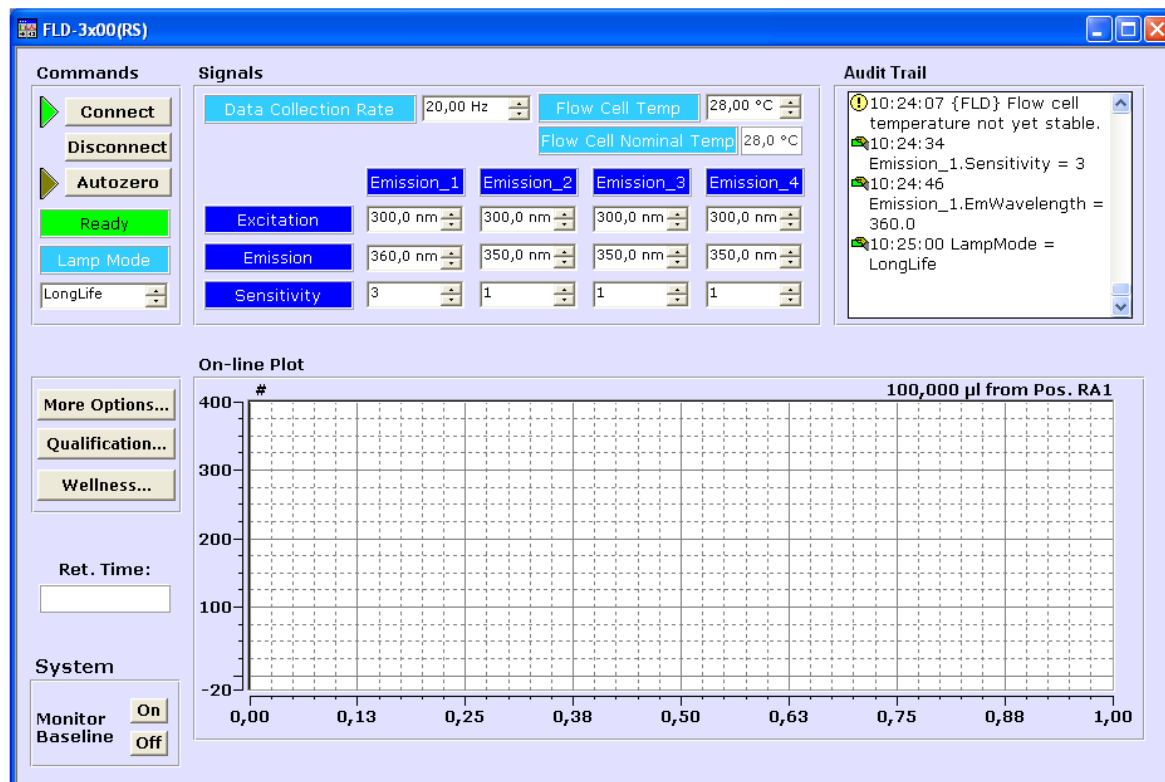

Fig. 30: Detector control panel (here FLD-3400RS)

The control panel provides access to the operating parameters and commands required for routine operation of the detector. Additional functions are available in the **Commands** dialog box. To open the **Commands** box from the panel tabset, select **Command** on the **Control** menu.

5.4.3 Automated Control

With automated control, you create a program file (PGM) for automated operation of the detector. Programs can be created automatically with the help of a software wizard or manually by editing an existing program.

In addition to programs for sample analysis, you can also create programs for special purposes, for example, to automate system shutdown (→ page 94) or to ensure that the system automatically restarts operation as desired after a power failure. For details, see the Chromeleon Help.

To create a program with the Program Wizard

1. Open the Program Wizard. On the **File** menu, select **New**, and then select **Program File**.
2. The wizard guides you through program creation. On each wizard page, make the desired settings or accept the default values. For additional information about a page, click **Help**. The page to be used for the fluorescence detector settings is named **FLD Options**.

First, select whether you want to record one or several emission channels. Select the parameters for the channel or channels in the table. For information about parameter settings, see page 77. The wizard page changes depending on whether you select one or several channels for recording data.

If you are recording a *single* channel, enter the expected (typical) minimum peak width at half height of the peak in the **Peak Width** box. Chromeleon calculates an appropriate data collection rate and response time on the basis of these two parameters. Click **Apply** to accept these values (recommended). Then select a lamp mode in the **Lamp Mode** box (→ page 88).

In addition, you can define the flow cell temperature (→ page 88) and the allowed deviation.

Start settings and data acquisition times:

No.	Channel name	AcqOn[<i>min</i>]	AcqOff[<i>min</i>]	Ex Wavel.[<i>nm</i>]	Em Wavel.[<i>nm</i>]	Sens.	
1	<input checked="" type="checkbox"/> Emission_1	0,000	30,000	300,0	350,0	1	Pr
2	<input type="checkbox"/> Emission_2						
3	<input type="checkbox"/> Emission_3						
4	<input type="checkbox"/> Emission_4						
5	<input checked="" type="checkbox"/> FLD FlowCell	0,000	30,000				

Signal Parameter Assistant

Please specify the peak width at half height for the narrowest expected peak in your chromatogram.

Peak Width [min]

Data Collection Rate [Hz]

Response Time [s]

Flow Cell Temperature

Temperature [None...50,00 °C]

Ready Temp. Delta [None...50,00 °C]

Data Collection Rate [0,00...100,00]

Response Time [None...60]

Lamp Mode

Diagram: A chromatogram showing a single peak. A red double-headed arrow indicates the width of the peak at its half-height, labeled "Peak Width".

Fig. 31: FLD Options page in the program wizard (Single-Channel)

When you record *multiple* channels (FLD-3400RS only), the baseline noise increases at higher data collection rates. The maximum data collection rate and response time depend on a number of parameters and are always automatically calculated on the basis of the selected parameters. In the **Multi Channel Performance** box, select a measuring performance (→ page 87).

In addition, you can define the flow cell temperature (→ page 88) and the allowed deviation.

i **Tip:** In Multi-Channel Mode, the selected lamp mode is always **HighPower**.

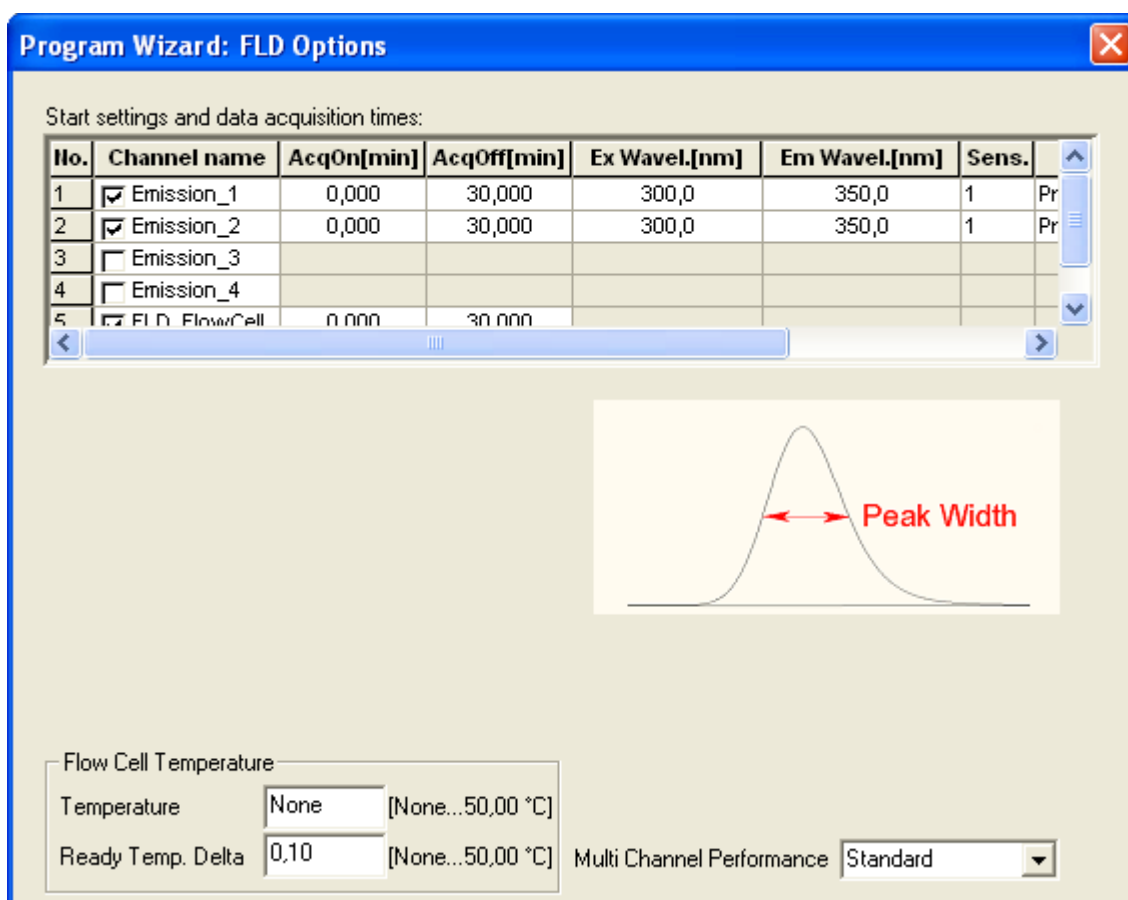

Fig. 32: FLD Options page in the program wizard (Multi-Channel)

3. After you finish the wizard, Chromeleon automatically creates the corresponding program.
4. To start the program, follow the steps below (→ page 71).

To create a program manually

1. Open an existing program.

Select and double-click the program you want to open.

—or—

On the **File** menu, select **Open**. In the dialog box, select **Program** on the **Object of Type** list and select the program.

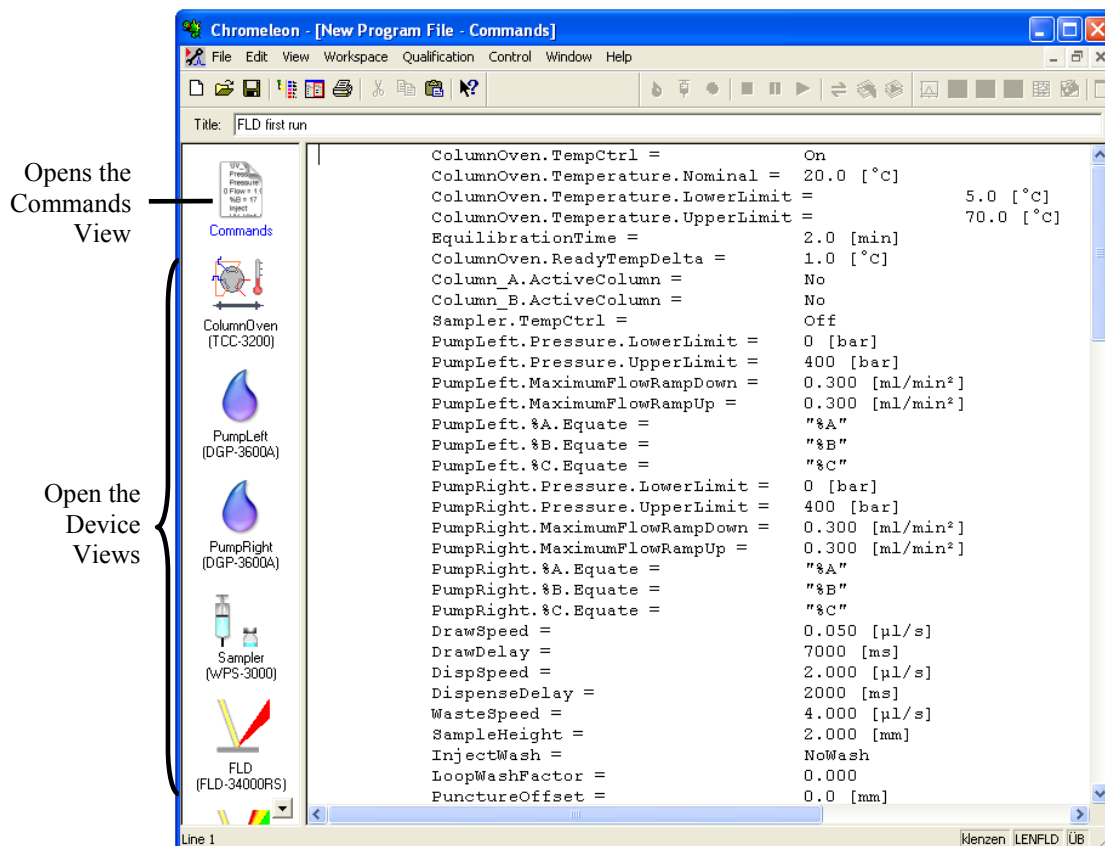

Fig. 33: Chromeleon program file (here program shown in the Commands view)

2. Change the settings in the program as desired.

The easiest way to edit a program is to do this in the Device Views (→ Fig. 33). Click a device icon and change the settings on the device pages. Editing the program in the Device Views ensures correct command syntax.

If you cannot edit a certain parameter in the Device View, click **Commands** to open the Commands View. The **Commands** view shows the entire program, listing the control commands in chronological order. For more information, see the Chromeleon Help.

3. To start the program, follow the steps in the next section.

To start a program

Program for sample analysis

1. Create a sample list (sequence). A sequence must include the program and a method for evaluating the sample data (for example, for peak identification, area determination, and amount determination).
2. Assign the program and method to each sample on the list.
3. Add the sequence to the batch and start the batch.

For information about each of the above steps, see the Chromeleon Help.

Other programs

Add the program to the batch and start the batch.

5.4.4 SmartStartup and SmartShutdown

The **SmartStartup** wizard assists you in automating regular routine tasks (→ page 51). With SmartStartup, the different modules of the UltiMate 3000 system are turned on automatically and in a controlled manner. For the fluorescence detector, for example, SmartStartup turns the flow cell heating on. In addition, SmartStartup can purge the pump of the HPLC system automatically, flush the column, and perform system equilibration. Important module parameters are monitored. When the modules operate within these limits, the sample sequence, which was set up before, can be started automatically. SmartStartup can be used at any time.

If you have to interrupt system operation, use the SmartShutdown wizard to create a program to set the HPLC system into standby mode or to automate shutdown of the system (→ page 94).

5.5 Operational Settings

5.5.1 Detecting Liquid Leaks in the Detector

Leak detection is enabled as a standard when the detector is shipped. When leak detection is active and the leak sensor reports a leak

- The Status LED on the front panel door is red.
- A message appears in Chromeleon and on the detector display.
- The **Leak** property in Chromeleon is set to **Leak_Detected**.
- A beep alerts you.

When the leak sensor reports a leak, eliminate the cause for the leakage and dry the leak sensor (→ page 113). If the leak is not eliminated immediately, Chromeleon aborts the running batch.

Disabling leak detection (not recommended):

In Chromeleon, open the **Commands** dialog box for the detector and set **LeakSensorMode** to **Disabled**.

Disabling the leak alarm

Call the Configuration menu on the detector display and set the Leak sensor mode to **Silent**. When a leak is detected, a message appears on the front panel display, but no beep sounds.

5.5.2 Adjusting the screen brightness or contrast

You can adjust the screen brightness or screen contrast to your requirements from Chromeleon or on the front panel display.

To adjust the settings from Chromeleon

1. Open the **Commands** dialog box for the detector.
2. Select **Brightness** and change the value for the screen brightness as appropriate. Select **Contrast** and change the value for the screen contrast as appropriate.

To adjust the settings on the front panel display

1. Show the function keys and select **Menu**.
2. Select the **Configuration** menu and select **Display & soft keys**.
3. Select **Brightness** and change the value for the screen brightness as appropriate. Select **Contrast** and change the value for the screen contrast as appropriate.

5.6 Operational Modes of the Detector

5.6.1 Single-Channel Mode

A fluorescence detector is usually operated in single-channel mode, that is, a *single* excitation/emission wavelength pair is measured. As this mode provides the highest possible data rates and best signal-to-noise ratio, always use the single-channel mode for very small peaks.

5.6.2 Multi-Channel Mode (FLD-3400RS Only)

In multi-channel mode, both monochromators quickly switch between the selected wavelengths. A single analysis is sufficient to measure several channels. The FLD-3400RS can acquire up to four wavelength pairs simultaneously. However, note that:

- Each additional channel increases the time that the detector requires to set the grating positions, reduces maximum possible data collection rate and leads to an increased baseline noise.
- Switching permanently between the wavelengths can lead to wear in the long term. The multi-channel mode is therefore only recommended for method development, but not for continuous routine operation.
- As an alternative, you can switch the wavelengths as often as required in a data channel in Chromeleon. Thus, you can switch the excitation and emission wavelength, respectively, and, if required, the sensitivity, the emission filter and the PMT. For further information, see section 5.7 (→ page 77) or the *Fluorescence Method Development Handbook* that is shipped with the detector.

 **Tips:** In Multi-Channel Mode, you cannot directly select the Response Time and Data Collection Rate, as these parameters are determined automatically (→ page 87) and adjusted accordingly when wavelengths are switched during the measurement.

In Multi-Channel Mode, the selected lamp mode is always **HighPower**.

Manual acquisition from the **Commands** dialog box is only supported for one channel.

5.6.3 Zero Order Mode

In Zero Order Mode, the grating of the emission monochromator is set to the position of zero order. In this position, the monochromator lets the entire spectrum pass, rather than only a certain wavelength. The excitation monochromator is set to one wavelength as usual. The FLD-3400RS allows you to cut off undesired wavelengths using the filter wheel setting (→ page 85). To activate the Zero Order Mode in Chromeleon, set the **EmWavelength** property to **ZeroOrder**.

Use this mode during method development, if you do not know the retention times of the various substances in your sample. As the entire range of emission wavelengths is acquired, you can determine the retention times of all substances in a single run.

The Zero Order Mode is also suitable for samples that emit light at a broad spectral bandwidth. In this case, the measured intensity is higher in Zero Order Mode than under normal operation. This allows you to measure samples with a lower concentration.

5.6.4 2D Scans

With the FLD-3x00(RS) detectors, you can also record several types of 2D spectra. The excitation monochromator or emission monochromator (or both simultaneously) moves over a settable wavelength range, while the intensity of the fluorescence signals is measured and recorded continuously for each wavelength. This allows you, for example, to record spectra for determining the optimum emission and excitation wavelengths.

During all scans, stop the pump flow or pump at a very low flow rate to achieve stable conditions in the flow cell of the fluorescence detector.

A baseline spectrum with the same parameters can be recorded for all scan modes. The baseline spectrum is stored and automatically subtracted from the recorded spectra. The result is a difference spectrum. If the parameters for a scan change, the background spectrum is automatically deleted and a new spectrum must be recorded. You can delete a baseline spectrum any time by using the **ClearBaseLine** command.

Chromeleon automatically saves the spectra, including the baseline spectrum, to a spectra library named **FLD3000.LIB**. The spectra library is saved in the timebase directory on the local data source. If a scan is performed during sample processing, the library is saved in the associated sequence.

There are three different scan types:

Excitation Scan

The wavelength on the emission monochromator is kept constant, while the excitation monochromator scans a wavelength range. The result is an excitation spectrum of the sample.

Emission Scan

The wavelength on the excitation monochromator is kept constant, while the emission monochromator scans a wavelength range. The result is an emission spectrum of the sample.

Synchro Scan

A user-defined excitation wavelength range is scanned, while the emission wavelength is scanned synchronously with a fixed distance. This allows you to determine rough values for the excitation and emission wavelengths of all substances in a first scan. However, the optimum excitation and emission wavelengths can be determined by using excitations scans and emission scans only.

To perform a 2D spectra scan

Spectra scanning can be performed manually (as described below) or by using a program. For additional information and more options for spectrum scans as well as program examples, see the Chromeleon Help.

i **Tips:** During the scan process, no other commands can be sent to the fluorescence detector.

The duration of the scan process depends on the range to be scanned and the selected scan speed.

Before each scan, select a detector sensitivity, using the **ScanSensitivity** command (→ page 81).

Artefacts may occur when scanning near extreme changes in the spectrum (which frequently occur near the excitation wavelength), for example, when scanning the Raman emission spectrum of water near the excitation of 350 nm. In this case, select a greater distance between the wavelength scan range and the edge. For the Raman emission scan, for example, select a start wavelength of 385 nm.

Manual spectra scans are supported under Chromeleon 6.80, but are currently not supported under Chromeleon 7.1 or later.

Complete the following steps to record an excitation spectrum:

1. Open the Commands dialog box for the detector. Under **ScanStartExWavelength**, enter the first wavelength of the range to be scanned and the last wavelength under **ScanEndExWavelength**. Select an emission wavelength (**ScanStartEmWavelength**) and a scan speed (**ScanSpeed**).
2. Stop the pump flow (**Flow=0**) or set it to a very low flow rate.
3. Execute the **ScanExcitation** command.

Complete the following steps to record an emission spectrum:

1. Open the Commands dialog box for the detector. Under **ScanStartEmWavelength**, enter the first wavelength of the range to be scanned, and the last wavelength under **ScanEndEmWavelength**. Select an excitation wavelength (**ScanStartExWavelength**) and a scan speed (**ScanSpeed**).
2. Stop the pump flow (**Flow=0**) or set it to a very low flow rate.
3. Execute the **ScanEmission** command.

Complete the following steps to perform a Synchro Scan:

1. Open the Commands dialog box for the detector. Under **ScanStartExWavelength**, enter the first wavelength of the range to be scanned, and the last wavelength under **ScanEndExWavelength**. Then enter the offset between the scanned wavelengths under **ScanSyncOffset** and select a scan speed (**ScanSpeed**).
2. Stop the pump flow (**Flow=0**) or set it to a very low flow rate.
3. Execute the **ScanSynchronous** command to run a synchro scan.

5.6.5 3D Scans (only Chromeleon 7.1 or later)

From Chromeleon 7.1 on, 3D scanning is supported for the FLD to facilitate determining the retention times and absorption maxima. As opposed to 2D scans, where the selected spectral range is scanned *once*, the spectral range is scanned continuously, resulting in a spectral field similar to a 3D field of a diode array detector. As for 2D scans, 3D scan modes include excitation scan, emission scan, and synchro scan.

Instrument methods must be used for recording the spectra. In the Instrument Method Wizard, select the **3D Data Acquisition on** option. All required parameters can be set on the **FL Field Settings** page of the wizard. During a 3D scan, no emission channels can be recorded.

The recorded 3D data are represented as a 3D data field in the **Contour Plot**. Use the 3D data field to determine the retention times and optimum emission or excitation wavelengths.

For more information about 3D data fields, see the Chromeleon 7.1 (or later) Help.

5.7 Optimizing Detector Performance

The performance of the detector can be optimized by careful selection of key operating parameters. The table summarizes these parameters, indicates the performance characteristics affected, and offers guidelines for selecting the parameters.

Operating Parameter	Performance characteristics affected	Selection guidelines
Excitation wavelength, emission wavelength	Fluorescence intensity, limit of detection, selectivity	→ page 78
Sensitivity	Baseline noise, max. fluorescence intensity	→ page 81
Filter wheel setting (FLD-3400RS only)	Baseline noise	→ page 85
Response time	Baseline noise, peak width, peak height	→ page 86
Data collection rate	Peak resolution, disk space, possibly baseline noise	→ page 86
Multi-channel performance	Data collection rate, response time, baseline noise	→ page 87
Flow cell temperature	Fluorescence intensity, reproducibility	→ page 88
Lamp mode	Lebensdauer der Lampe, Basislinienrauschen, maximale Datenaufnahmerate	→ page 88
Baseline behavior	Course of the baseline after switching the wavelength, sensitivity, filter wheel, or PMT.	→ page 89

In Chromeleon, you can set the operating parameters manually in the **Commands** dialog box for the detector (→ page 65) and on the page for the detector of the Panel Tabsets (→ page 66). When you create a program with the Program Wizard, you can enter most parameters on the **FLD Options** page (→ page 68).

Fluorescence Method Development Handbook

Basic information about how to optimize the detector performance can be obtained from the following sections of these Operating Instructions and from the *Fluorescence Method Development Handbook* that is shipped with the detector. The *Fluorescence Method Development Handbook* includes technical background information and describes additional aspects that may be helpful when further optimizing the detector performance.

5.7.1 Determining the Optimum Excitation and Emission Wavelength

The most important parameters that need to be optimized are the excitation and emission wavelength. Note the following key criteria for determining the wavelength for an analysis:

- Preferably, select an excitation wavelength on the absorption maximum of the sample components.
- The mobile phase should be "transparent", showing little or no absorption, at the selected wavelength. Thus, the excitation wavelength should always be above the UV cutoff of the solvent (→ table page 123).
- Select an emission wavelength that is at least 20 nm above the excitation wavelength.

The following section outlines two methods to determine the optimum wavelengths. After you have determined the optimum wavelengths and the retention times, you should perform another analysis run using these parameters to determine a suitable sensitivity (→ page 81).

Method using 1 sample with the fluorescence detector

1. Set the excitation wavelength to a wavelength at which most sample components absorb. Many fluorescent molecules absorb at 250 nm. Set the filter wheel setting to a wavelength that is at least 30 nm above the excitation wavelength (in the example 280 nm). Run a sample analysis in Zero Order Mode. To activate the Zero Order Mode in Chromeleon, set the **EmWavelength** property to **ZeroOrder**. You will get a peak for most sample components, provided that the emission wavelength is not (significantly) smaller than the selected filter wavelength.
2. From step 1 you have obtained the retention times of the sample components. Perform an emission scan for each sample component at its retention time. The excitation wavelength remains 250 nm. You will get the optimum emission wavelengths (largest peak) for each sample component. (Even if the excitation wavelength is not selected at the excitation maximum, the resulting emission spectrum is identical in most cases.)
3. Now perform an excitation scan for each sample component using the optimum emission wavelengths to determine the optimum excitation wavelengths (largest peak).

Method using 2 samples of different concentrations with a diode array detector and the fluorescence detector

If your UltiMate 3000 system includes a diode array detector (DAD-3000 or DAD-3000RS), you can use the UV spectrum determined with the diode array detector to find the optimum excitation wavelengths and retention times.

1. Use a sample with a concentration that is suitable for diode array detectors (for example, 100 ng/μL) and run an analysis with the DAD, recording a 3D field. You can extract the retention times and absorption maxima, and thus the optimum excitation wavelengths, of each sample component from the Chromeleon 3D plot (→ Fig. 34, page 79).
2. Use a sample with a concentration that is suitable for fluorescence detectors (for example, 100°pg/μL for high-fluorescing substances) and run an emission scan for each sample component with the FLD, using the retention times and excitation wavelengths. Note that you may have to add a time offset between the DAD and FLD when determining the retention times if the two detectors are connected in series. You will get the optimum emission wavelengths (largest peak) for each sample component.

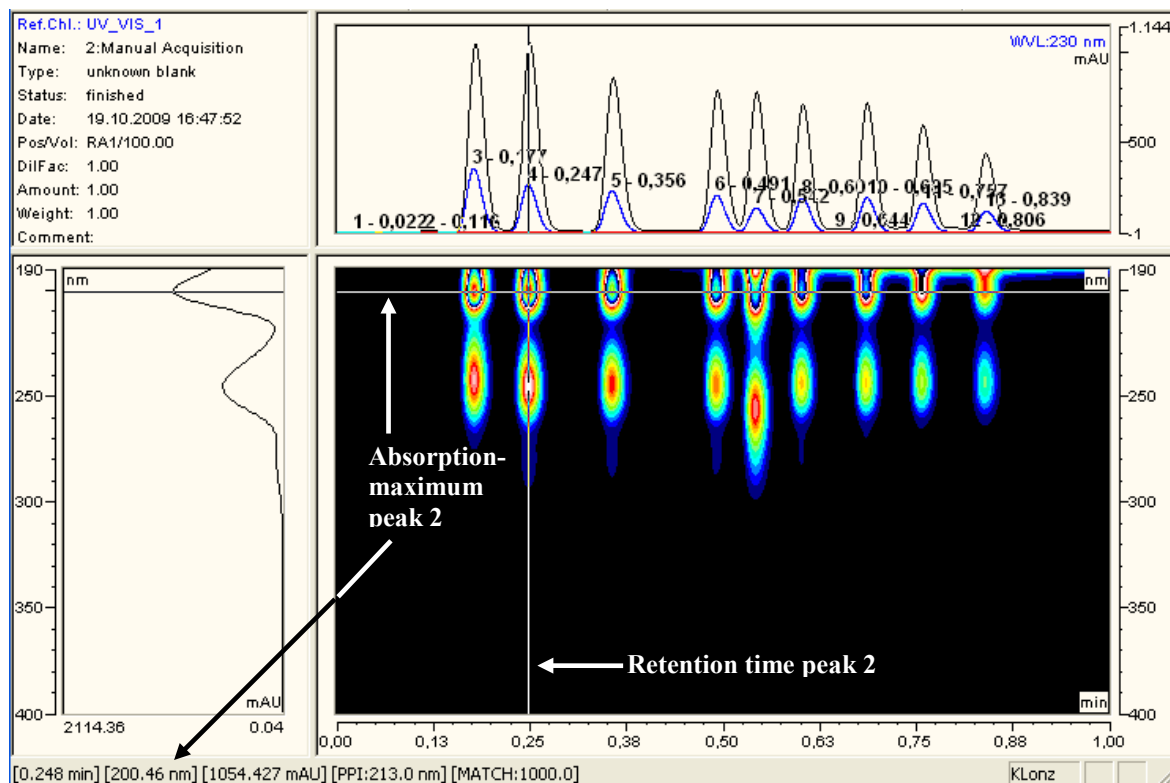

Fig. 34: 3D data recorded with a diode array detector

i Tip: Chromeleon 7.1 (or later) supports 3D spectra scanning for the FLD, which facilitates determining the retention times and absorption maxima without a diode array detector (→ page 76).

Wavelength switching in Chromeleon

Thermo Fisher Scientific recommends using the single-channel mode to record data by switching the wavelengths in-between the detected peaks of the various sample components, rather than to simultaneously measure all interesting wavelengths in multi-channel mode.

Use the Program Wizard to set the start wavelengths for one channel (→ page 68). After completion of the wizard, open the program in the Program Editor (→ page 70). In the Device View for the detector, on the **Timetable** tab page, you can define the times for switching the wavelengths.

Setting the wavelengths for multiple channels in Chromeleon

On the **Signals** page in the detector **Properties** dialog box, verify that the channels you want to record were selected by the **Enabled** check box during the installation of the detector (→ page 43). If they were not, the detector cannot collect raw data for these channels.

Use the Program Wizard to set the wavelengths for all channels (→ page 68).

5.7.2 Sensitivity (Detector Sensitivity)

The sensitivity is used to optimize the signal-to-noise ratio in a chromatogram. Depending on the intensity of the fluorescence, it may be necessary to adjust the sensitivity several times during an analysis. To find the best sensitivity, it is required to determine the maximum emission intensities. This section describes a method for this and the technical background.

Background

A PMT (or optionally two PMTs) measures the intensity of the emission light after the emission monochromator. The sensitivity of the PMT can be adjusted in 8 steps (1 to 8) with the Sensitivity parameter. With each step, the sensitivity of the PMTs increases by approximately a factor 2. If a peak with sensitivity = 5 is 15 million counts high, for example, the peak height increases to 30 million counts when the sensitivity = 6 (→ Fig. 35).

- If the selected sensitivity is *too small*, the peak height is reduced and the signal-to-noise ratio is not optimal (→ Fig. 35, Sensitivity = 1).
- If the selected sensitivity is *too large*, the PMT signal is saturated. In this case, the detector automatically reduces the sensitivity. Lines appear in the chromatogram at the beginning and at the end of the saturation (→ Fig. 35, Sensitivity = 8). If the detector is not saturated any more, the Sensitivity setting before saturation is restored.

 **Tips:** When the sensitivity was automatically reduced or when the initial value was restored, the Chromeleon Audit Trail shows a warning with the new sensitivity value after the adjustment.

Calibration depends on the PMT. Therefore, calibration and quantification must always be performed with the same PMT.

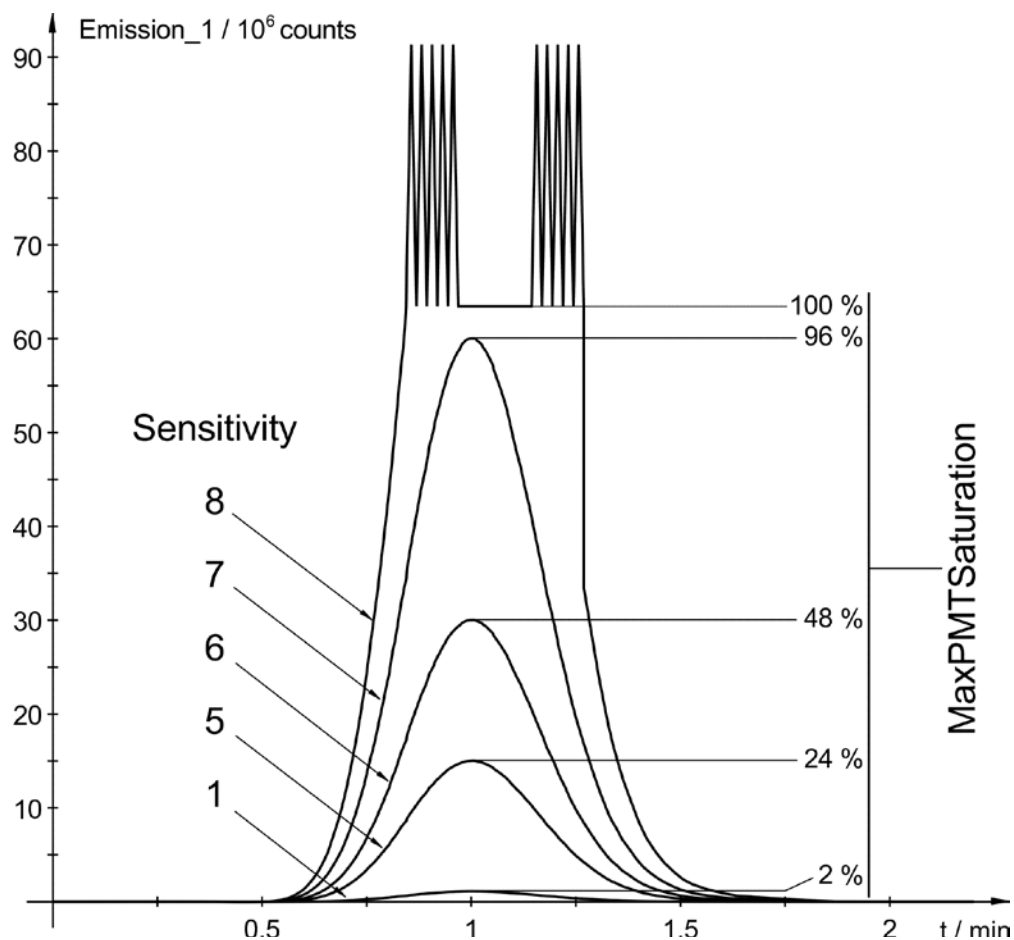

Fig. 35: Effects of the Sensitivity setting

Determining the optimum Sensitivity

Determine the optimum sensitivity in a separate sample run after you have determined the optimum wavelengths (→ page 78). Use a sample (standard) with the maximum expected concentration of the analytes and select a sensitivity at which a saturation is not expected (for example; 1 or 2). If the peak heights of the individual peaks in a chromatogram differ, you can improve the signal-to-noise ratio of the smaller peaks by switching the sensitivity during the run. You can select the Sensitivity for all channels directly in the Program Wizard (→ page 68).

With the FLD-3x00(RS), the intensity of the emission light (measured by the PMT) is normalized with the intensity of excitation light through the sample (measured by the reference diode). Therefore, the values (counts) that the emission channel displays cannot be used for optimizing the sensitivity. In Fig. 35 the PMT is saturated at 63 million counts. However, under different measuring conditions, the PMT may be saturated at a value of 100 million counts, for example.

Therefore, use the **MaxPMTSaturation** parameter to optimize the Sensitivity (→ Fig. 35 right). This parameter continuously stores the maximum PMT saturation in percent of the saturation value. A program example can be found in the Chromeleon Help.

1. Open the program you want to optimize in the **Commands** View. The required commands must be added to the program manually.
2. Add a **Log** command for the **MaxPMTSaturation** property after the peak maximum of an expected peak (or group of peaks) to log the maximum saturation value at this time in the Audit Trail (→ Fig. 36).
3. Add a **ClearMaxPMTSaturation** command shortly after, before the next peak elutes, to reset the **MaxPMTSaturation** value to zero (→ Fig. 36).
4. Repeat steps 2 through 3 for all peaks.

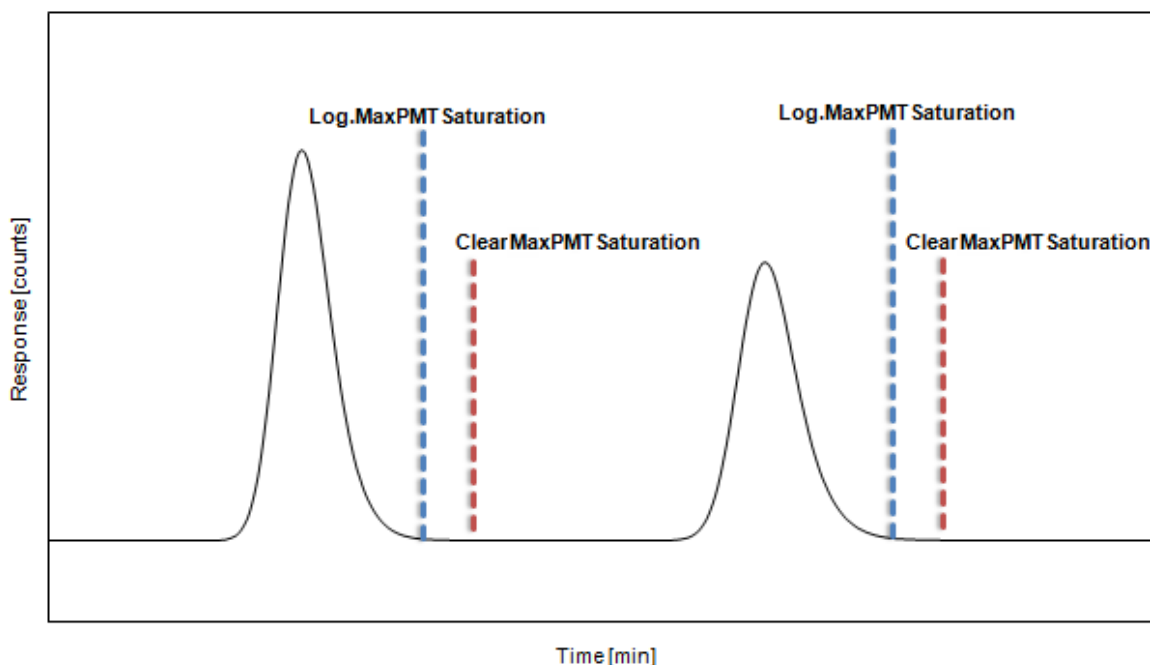

Fig. 36: Monitoring the MaxPMTSaturation parameter

Run a sample and read out the **MaxPMTSaturation** values in Chromeleon and evaluate the results:

Value	What you should do...
< 30%	Increase the Sensitivity. The following is a rough guideline: < 30 %: by one stage < 15 %: by two stages Then repeat the optimization, starting with step 1.
30% - 80%	The Sensitivity value is optimal.
80% - 99%	The Sensitivity should be reduced by 1 step to avoid undesired saturation when concentration varies.
≥ 100%	The Sensitivity must be reduced by at least one step. In most cases, the detector has reduced the PMT sensitivity by autoranging. Check the Audit Trail for the smallest sensitivity value after the autoranging and repeat the optimization with this value, starting from step 1.

If you do not know the expected concentrations of the analytes, reduce the Sensitivity even at smaller values of **MaxPMTSaturation**.

i **Tips:** The maximum saturation shown with **MaxPMTSaturation** affects the signals of both PMTs with the parameters of all channels.

You can completely turn off fluorescence detection by setting the sensitivity to **Off**. This may be required, for example, if you want to record the incoming signal from a UV detector for a sample of high concentration, or to suppress an extremely high peak that is not of interest for you but triggers an automatic adjustment of the sensitivity.

5.7.3 Filter Wheel Setting (FLD-3400RS only)

To prevent this stray light from reaching the PMT, additional optical edge filters are installed in the light path between the flow cell and the emission monochromator. This reduces direct scattering of light from the light source. In addition, a grating monochromator lets unwanted fractions (the half, one third, ...) of a selected wavelengths pass. If the monochromator is set to 500 nm, for example, second-order stray light at 250 nm from the sample may reach the PMT. The filters also eliminate this higher-order stray light.

Ideally, these filters let all wavelengths above their cut-off wavelength pass, while light with a smaller wavelength than the cut-off wavelength is blocked. In practice, there is a transition area where the transmission of the light increases from the lower wavelengths near the range where the light is cut off to the higher wavelengths near the range where the light passes. Fig. 37 shows the transmission behavior of the 280 nm filter, which is the filter that is installed in the FLD-3100 before the emission monochromator.

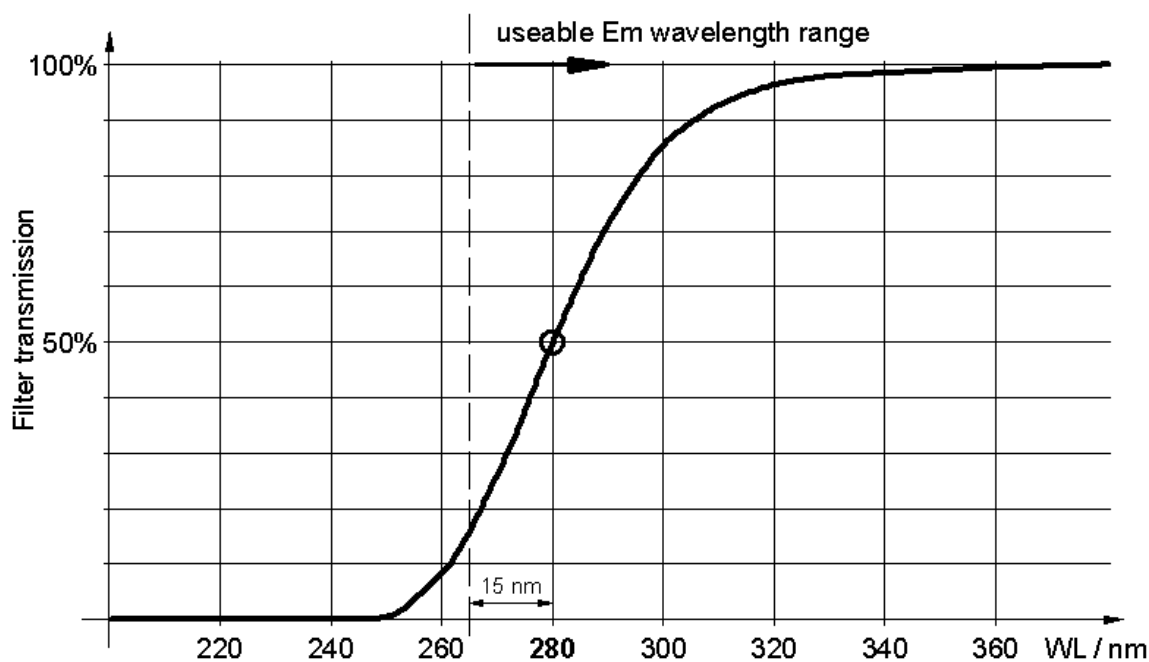

Fig. 37: Transmission behavior of the 280 nm filter

The FLD-3400RS provides a filter wheel that is located before the emission monochromator. The filter wheel carries several optical filters with different cut-off lengths. The qualitative transmission behavior of all filters is shown in Fig. 37, with a transmission range of approx. +/- 30 nm. At the cut-off wavelength, the filters let 50% of the light pass. The filter wheel setting can be selected automatically or manually.

- If the filter wheel mode is set to **Auto**, the detector automatically selects a filter wheel position. It selects the first filter with a cut-off wavelength below the selected emission wavelength. This mode is selected by default and provides best results for most applications.

- You can manually select the filter wavelength. Available filters are 280 nm, 370 nm, 435 nm or 530 nm. The selected emission wavelength must not be more than 15 nm below the filter wavelength. In special situations (for example, if the emission wavelength is near the cut-off wavelength of a filter), setting the filter manually may provide better results than the **Auto** setting.

If you select **Open**, the filter wheel remains in an open position. Use this setting if you want to measure with an emission wavelength between 220 nm and 280 nm.

Manually select the filter wheel position, for example, in combination with the Zero Order Mode. The emission monochromator opens and the emitted light is measured over the entire wavelength range. Use the cut-off filter to suppress light below the wavelength you are interested in. Note that this setting usually requires a lower Sensitivity setting due to the stray light and auto fluorescence of the eluent (the entire spectral range is recorded).

You can select the filter wheel setting for all channels directly in the Program Wizard (→ page 68).

For further information about selecting the filter wheel setting, refer to the *Fluorescence Method Development Handbook* that is shipped with the detector.

5.7.4 Response Time and Data Collection Rate

 **Tip:** In Multi-Channel Mode, you cannot directly select the Response Time and Data Collection Rate, as these parameters are determined automatically (→ page 87).

The response time is a measure of how quickly the detector responds to a change in signal. The data collection rate is the number of data points per second (Hz) that Chromeleon collects from the detector and stores as raw data.

The Program Wizard in Chromeleon automatically calculates the appropriate response time and data collection rate, based on the value you enter for the peak width at half-height (→ Fig. 31, page 68). If you want to select a different response time and data collection rate, note the following guidelines:

Response time

- Select a response that is about 1/3 of the peak width at half-height of the narrowest peak of interest. A longer response time allows more averaging of the signal and results in less short-term noise.
- However, if the selected response time is too long, this can result in reduced peak heights and asymmetrical peak shapes. Peaks that elute shortly after each other may not be separated properly. When set correctly, the response time significantly reduces baseline noise, but reduces peak height only slightly.

Data collection rate

- Data can be generated with a maximum collection rate of 100 Hz or 200 Hz (FLD-3400RS under Chromeleon 7.1 or later). The **LongLife** lamp mode supports a maximum data collection rate of 20 Hz.
- In general, each peak should be defined by at least 20 data points. For chromatograms with co-eluting peaks or low signal-to-noise ratios, 40 data points per peak is recommended.
- If all peaks are relatively wide, select a slower data collection rate (for example, 1.0 Hz). This saves disk space and allows for a faster display of data in Chromeleon.
- If the data collection rate is too slow, the start points and end points of peaks will not be determined accurately.
- If any peaks of interest are less than a few seconds, select a faster data collection rate (10.0 Hz, for example). If the collection rate is too high, data files may need more disk space and post-run analyses may require more processing time.

5.7.5 Multi-Channel Performance

In multiple wavelength applications, baseline noise increases at higher data collection rates. The maximum data collection rate depends on a number of parameters, for example, the number of recorded channels and the wavelength ranges. Therefore, in Multi-Channel Mode, the Data Collection Rate and Response Time are always automatically calculated on the basis of the selected parameters. However, you can select the measuring performance (Multi-Channel Performance). Determine whether the measurement is performed faster, but with more noise, or whether minimum noise is required, which means a longer measuring time and thus a lower Data Collection Rate. The possible values are: **UltraFast**, **Fast**, **Standard**, **LowNoise**, **UltraLowNoise**.

Use the Program Wizard to set the measuring performance for all channels (→ page 68) if you have selected multiple channels.

5.7.6 Flow Cell Temperature

The temperature of a sample influences its fluorescence. Thus, a problem with fluorescence detection is that the results can strongly be influenced by fluctuations in ambient temperature. The FLD allows you to heat the flow cell and thus keep temperatures inside the flow cell at a constant level. Thus the temperature remains the same during measurements, even if ambient temperatures change.

As the fluorescence of a sample decreases as temperature increases, the temperature must not be selected too high. However, it must be above the temperature inside the detector optics, which is influenced by the ambient temperature. Therefore, select a temperature that is roughly 15°C above the expected ambient temperature.

Example: The expected maximum temperature in the laboratory is 27°C (80.6 F). Set the flow cell temperature to 42°C (107.6 F).

Use the Program Wizard to define the flow cell temperature and the allowed deviation (→ page 68).

5.7.7 Lamp Mode

The FLD offers three different modes for the xenon flash lamp:

- In **HighPower** mode, the lamp flashes at the highest frequency. This mode is recommended for applications that require highest sensitivity. It is selected automatically when you are recording multiple wavelength channels. The sensitivity is roughly twice the sensitivity in Standard mode. The expected lifetime of the lamp is approximately 1300 hours. (Only the time during data acquisition is counted.)
- In **Standard** mode, the lamp flashes at a medium frequency. This mode is recommended for applications that require a high sensitivity. The expected lifetime of the lamp is approximately 4000 hours. (Only the time during data acquisition is counted.)
- In **LongLife** mode, the lamp flashes at a lower frequency. When the xenon lamp is operated in this mode, the lamp life is approximately four times the lifetime in Standard mode. However, note that signal-to-noise ratio is reduced to roughly the half. The expected lifetime of the lamp is approximately 16000 hours. (Only the time during data acquisition is counted.)

This mode only supports data collection rates up to 20 Hz. If you select the **LongLife** mode and a data collection rate higher than 20 Hz, the data collection rate will be automatically reduced.

You can select the Lamp Mode directly in the Program Wizard (→ page 68) if you have selected a single wavelength channel.

i **Tip:** You can change the lamp mode during a measurement, for example, from **LongLife** mode (between the peaks) to **Standard** or **HighPower** mode (for the interesting peaks). This extends the lamp lifetime, without any loss in sensitivity in the important areas. For further information about the modes for the Xenon lamp, refer to the *Fluorescence Method Development Handbook* for the detector.

5.7.8 Baseline Behavior

If wavelengths are switched or the sensitivity, filter wheel, or PMT setting are changed during a program, the chromatogram may show baseline jumps. You can define how the baseline behaves in these cases. Select whether you want to automatically perform an autozero (**Zero**), to append the baseline to the previous signal (**Append**), or to let the baseline "jump" to the new value (**Free**).

To set the baseline behavior in Chromeleon

1. Open the **Commands** dialog box for the detector.
2. Click **BaselineBehavior**.
3. Select the preferred setting from the list.
4. Click **Execute**.

i **Tip:** Using the **AutoZero** command, you can perform an autozero any time, that is, the intensity measured at the time of the autozero is subtracted from any intensities measured thereafter. Always select a time at which no sample flows through the cell to perform an autozero. The values are stored and can be reset using the **ClearAutoZero** command.

5.8 Monitoring System Functions

This section provides a short overview of some special functions for qualification, documentation and monitoring the system that Chromeleon supports for the detector. Some functions are available also on the control panel for the detector. For additional information about a function, see the Chromeleon Help.

For information about how to monitor the remaining lamp lifetime, refer to section 7.2 (→ page 108).

5.8.1 Wavelength Calibration and Verification

A simple calibration procedure is performed after power-up of the detector. This requires that a flow cell is installed in the detector. During the calibration process, ensure that the eluent composition in the flow cell does not change and no air bubbles are present in the flow cell. If the message "Not calibrated" appears when the detector is turned on, verify that these conditions are met and execute the **Calibrate** command in Chromeleon.

In addition, you can verify the wavelength calibration using water (Raman measurement). If verification fails, that is, if the calibration shows a significant deviation, you can perform a wavelength calibration using water (Raman measurement). During wavelength calibration, the light spectrum of the xenon flash lamp is used to calibrate the excitation wavelength. Afterward, the emission monochromator is adjusted with the help of the maximum of the Raman emission spectrum (379 nm).

The following conditions *must* be met for both wavelength verification and Raman wavelength calibration:

- The system is equilibrated and environmental conditions are stable.
- There are no air bubbles in the flow cell. We recommend degassing the water. Set a flow rate of 0.5 mL/min and wait about 15 minutes before you begin, until the baseline is stable.
- The water has no impurities. Always use fluorescence-grade water and consider using a filter or a suitable column before the detector.

To perform wavelength verification

You can perform wavelength verification via Chromeleon. Wavelength verification can take a few minutes. During this time, data acquisition is not possible.

1. Open the **Commands** dialog box for the detector.
2. Select **ValidateRaman** to start the verification.

The following message appears in Chromeleon:

Make sure that

- the system is equilibrated and conditions are stable
- fluorescence-grade water is flowing through the cell
- the water is degassed (no air bubbles) and free of particles

Confirm with **OK** if you are sure that the above conditions are met.

The result (passed/failed) is displayed in the Chromeleon Audit Trail.

Passed: The calibration accuracy is within the allowed deviation range. The exact wavelength can be found under **RamanValidationWL**. The ideal value for the measurement is 397 nm.

Failed: The calibration of the detector is not sufficient. Perform a wavelength calibration (→ page 91). If wavelength verification fails again after the recalibration, check the causes and remedial actions outlined in section 6.3 (→ page 102).

Wavelength Calibration

You can perform wavelength calibration via Chromeleon. Wavelength calibration can take a few minutes. During this time, data acquisition is not possible.

1. Open the **Commands** dialog box for the detector.
2. Select **CalibrateRaman** to start the calibration. The following message appears in Chromeleon:

Make sure that

- the system is equilibrated and conditions are stable
- fluorescence-grade water is flowing through the cell
- the water is degassed (no air bubbles) and free of particles

Confirm with **OK** if you are sure that the above conditions are met.

3. The new calibration values are stored in the detector.
4. Perform wavelength verification.

5.8.2 Recording the Flow Cell Temperature

The **FLD_FlowCell** channel for recording the flow cell temperature is available in the **Commands** dialog box for the detector and on the **FLD Options** page in the Program Wizard (→ page 68).

Thermo Fisher Scientific recommends always recording the flow cell temperature. If a problem occurs, the temperature channel can provide helpful information to identify and eliminate the source for the problem.

5.8.3 Predictive Performance

Predictive Performance provides various functions for estimating the lifetime of consumables and for monitoring and recording service and (re)qualification information.

After you have ...	Perform the following command ...
Serviced the detector (for example, annual maintenance)	ServiceDone
Performed instrument qualification	QualificationDone

These commands reset the related counters and update the information when the action was performed.

Control Panel

On the control panel for the detector, click **Wellness**, **Qualification**, and **Service** to see the related predictive performance commands and parameters on separate panels. You can define limits and grace periods for service and qualification intervals. In addition, wellness bars provide visual indicators of qualification and service periods.

Color	Description
Green	Ok
Yellow	The value will soon reach the specified limit and/or the related component needs servicing or should be replaced soon.
Orange	(Only for monitoring Qualification properties.) The value has reached the specified limit. However, a Grace Period has been specified during which the component may still be operated.
Red	The value has reached the specified limit. Replacement, servicing, or qualification of the detector is overdue. The detector can no longer be operated. Besides, it is not possible to start a batch.

5.8.4 Operational Qualification and Performance Qualification

Operational Qualification and Performance Qualification allow you to check and document the performance of the HPLC system. All materials required for performing qualification and detailed instructions are available on request.

5.9 Shutting Down the Detector

Observe the following precautions before interrupting the operation or before shipping the detector:

- Even during periods of detector inactivity, a flow cell or the cover shipped with the detector must be installed. This is to prevent dust particles from causing damage to the detector optics.
- Rinse out any solvents from the flow cell, for example, by using isopropanol. You can flush the flow cell by using the optional syringe injection/flushing kit (part no. 6078.4200). During longer idle times, the flow cell should not be filled with pure water to avoid the growth of algae. Add a suitable proportion of isopropyl alcohol, for example, and plug the flow cell input and output using the plugs that were installed when the flow cell was shipped (→ Fig. 19, page 54). Using different plugs and tightening them may destroy the flow cell.
- When shipping the instrument, *remove* the flow cell and install the special cover to protect the flow cell opening. The flow cell must be shipped in its original packaging.
- Ship the module only in the original shipping container and observe the packing instructions. Shipping the unit in any other packaging automatically voids the warranty. If the original shipping container is not available, appropriate shipping containers and packing material can be ordered from Thermo Fisher Scientific sales organization for Dionex HPLC products. The packing instructions are included in the "Installation and Qualification Documents for Chromatography Instruments" binder and are also available on request.

If you are running Chromeleon, you can set the detector and HPLC system into the standby mode or automate system shutdown, as described in the sections below.

Standby Program

A standby program sets the HPLC system into standby mode. The application can be reactivated very quickly afterward. The pump flow is automatically reduced at the end of the program, and the temperature of all temperature-controlled system modules, for example, the FLD flow cell heating, can be reduced or the temperature control turned off.

Shutdown Program

A shutdown program automates shutdown of the HPLC system. The pump flow is automatically stopped at the end of the program. Certain system components and functions are turned off (for example, detector lamps, temperature control of the column oven or FLD flow cell heating).

To create a standby or shutdown program

Select one of the following alternatives:

- Select and perform the operating commands and parameters from the **Commands** dialog box.
- Create and run a corresponding program to automate the process (→ page 67).
- Use the SmartShutdown Wizard to create and run the program (see the next section).

To create the program with the SmartShutdown wizard

1. To open the wizard, click SmartShutdown on the Batch menu.
2. Follow the instructions as they appear on each page of the wizard. For additional information about a page, click **Help**.
3. After you finish the wizard, Chromeleon
 - ◆ Creates the program and saves it in the timebase for which you create the program.
 - ◆ Opens the **Start Batch on** dialog box.Select the program and click **Start** to run the program.

For more information about the SmartShutdown wizard, see the Chromeleon Help.

5.10 Routine and Preventive Maintenance Intervals

The detector is made of high-quality components and materials to minimize maintenance requirements. All surfaces are well resistant to weak acids, alkali, and organic solvents. Nevertheless, immediately wipe up all liquids spilled onto the detector surface by using lint-free cloth or paper. If surfaces are exposed for longer periods, these liquids can cause damage.

Perform the maintenance procedures listed in the table at regular intervals to ensure optimum performance and maximum uptime of the detector. The exact maintenance schedule for the detector will depend on a number of factors.

Frequency	What you should do...
Daily	Inspect the fluid connections for indications of leakage or restrictions.
	When buffer solutions are used, flush the system thoroughly after use. Use a solvent that does not contain buffers or salts.
Regularly	Check the drain tube for discharging liquid that may have accumulated in the interior of the detector. The tube is connected to the drain port at the front right of the detector (→ page 47). Verify that the tubing is unclogged and is routed below the drain port. Check the volume of the liquid in the waste container and empty as needed.
	Monitor the lamp (→ page 108).
Annually	Have a service representative check the detector once a year to prevent contamination and excessive wear.

 **Tip:** Chromeleon supports functions for monitoring qualification and service intervals (→ page 92).

6 Troubleshooting

6.1 Overview

The following features help you to identify and eliminate the source for problems that may occur during the operation of the detector or UltiMate 3000 system.

Status Screens

The status indicators on the front panel provide a quick visual check of the operational status of the detector. They indicate whether the detector is turned on, connected in Chromeleon, and operating properly (→ page 21).

Error Messages

If a fault or error is detected during the operation of the detector, a message appears on the detector display. Check the Messages on the Detector Display section for recommended courses of action (→ page 98). If the detector is operated by Chromeleon, a message is also displayed in the Chromeleon Audit Trail.

 **Tip:** For information about operating problems that might occur during the operation of an UltiMate 3000 system, see Operating Problems (→ page 102).

If you are unable to eliminate a problem following the instructions given here, contact the Thermo Fisher Scientific Service for Dionex HPLC products.

6.2 Messages on the Detector Display

Each time a fault or error occurs during the operation of the detector, the **Status** LED on the front panel door changes to red (or orange) and a message appears on the detector display. In this case, the **Prev**, **Next**, and **Clear** keys appear on the navigation bar.

To ...	Select ...
Return to the previous message.	Prev
Proceed to the next message.	Next
Remove a message from the display.	Clear

These keys are active also when the detector is connected with Chromeleon.

If the detector is connected with Chromeleon

- The message is also displayed in the Chromeleon Audit Trail.
- Messages on the front panel display can be removed also via the **ClearDisplayError** command in Chromeleon.

The following table lists the most important detector-related messages along with recommended remedial actions. In addition to the messages in the table, other messages may appear. In this case, note the exact wording of the message and contact Thermo Fisher Scientific Service for Dionex HPLC Products if you are unable to eliminate the problem.

Message	Remedial Action
Command rejected - device is busy.	Wait until the detector has executed the active command and retry.
Command rejected - device standby.	The detector was turned off by the Standby button. Turn on the detector and try again.
Data not available	Verify that the flow cell is properly installed. Open and close the front panel door. Turn the detector off and on again by pressing the power switch on the rear of the detector.
Download failed.	The firmware download failed. Repeat the firmware download.
Download firmware mismatch.	Verify that you have selected the correct firmware file. Repeat the firmware download.
Flow cell found. CalibrateRaman recommended.	A new flow cell was found. It is recommended to perform a wavelength calibration (→ page 91); without calibration, wavelengths may deviate from the actual wavelength by up to a few nanometers.
Flow cell ID chip not found.	Verify that the flow cell is properly installed. Open and close the front panel door. Turn the detector off and on again by pressing the power switch on the rear of the detector.

Message	Remedial Action
Flow cell temperature sensor not found.	Verify that the flow cell is properly installed. Open and close the front panel door. Turn the detector off and on again by pressing the power switch on the rear of the detector.
ID bus controller error	Turn the detector off and on again by pressing the power switch on the rear of the detector.
ID bus short circuit detected.	Remove the flow cell. Turn the detector off and on again by pressing the power switch on the rear of the detector. If the error occurs again with the flow cell installed, contact Service.
Internal hardware configuration failure.	Turn the detector off and on again by pressing the power switch on the rear of the detector.
Invalid PMT selection for excitation scan.	You cannot select both PMTs (PMT1 and PMT2) for excitation scans. Select either the standard (PMT1) or the infrared (PMT2) PMT.
Leak detected.	The leak sensor has reported a leak. Check the flow cell for indications of leakage. Retighten leaking connections if necessary. Dry the leak sensor (→ page 113).
Leak detected - eliminate within approx. x seconds.	The leak sensor has reported a leak. Check the flow cell for indications of leakage. Retighten leaking connections if necessary. Dry the leak sensor (→ page 113).
Memory failure - flash access error.	The firmware download failed. Repeat the firmware download.
No flowcell found.	Verify that the flow cell is properly installed. The lamp is automatically turned off when a flow cell is missing.
Not calibrated.	The detector is not calibrated. Verify that a flow cell is installed correctly and that the eluent composition in the flow cell does not change and no air bubbles are present. Then open and close the front panel door.
Overflow - scan data invalid.	Signal overflow. Repeat the scan with a lower sensitivity.
Qualification interval warning % days remaining.	The qualification interval will expire after the number of days indicated in the message. Perform a qualification.
Qualification out of date or missing.	The qualification interval has expired. Perform a qualification.
PMT Autorange for <CHANNEL> ignored, (...).	The detector was unable to perform autoranging (the automatic reduction of the sensitivity when the detector becomes saturated), as the Sensitivity was changed manually at the same time.
PMT sensitivity autorange for <CHANNEL> -new sensitivity is x.	The detector had to automatically reduce the Sensitivity. Select a suitable Sensitivity (→ page 81) and repeat. The Chromeleon Audit Trail shows a warning, in which x indicates the new sensitivity value after the adjustment. Use this value in your method when you expect similar concentrations.
PMT sensitivity change aborted autorange for <CHANNEL>.	The Sensitivity was changed manually during autoranging (the automatic reduction of the sensitivity when the detector becomes saturated).

Message	Remedial Action
PMT sensitivity restored for <CHANNEL> - new sensitivity is x.	The Sensitivity was restored to the initial value (= x) after automatic adjustment.
Scan command with equal start and end position.	Enter a different start and end time for the wavelength scan range.
Service interval expired.	The service interval has expired. Have authorized service personnel perform system maintenance.
Service interval warning - % days remaining.	The service interval will expire after the number of days indicated in the message. Have authorized service personnel perform system maintenance.
Signal overflow in channel xxx.	The reference signal is too low (high absorption, high PMT signal). Check if the flow cell is contaminated. Consider cleaning or replacing the flow cell. Check if the eluent concentration is too high. The lamp may be too old and may have to be replaced.
System fan operation failure.	Turn the detector off and on again by pressing the power switch on the rear of the detector.
System overtemperature detected.	Verify that the ventilation slots on the side panels are not obstructed, and that there is sufficient clearance behind and to the sides of the detector for ventilation. Reduce the room temperature, if necessary.

When the detector is operated with Chromeleon and if communication between Chromeleon and the detector cannot be established, related messages may appear in the Chromeleon Audit Trail.

Message	Remedial Action
FLD-3100@USB-1610103 - Device not found on the USB.	The USB connection between the detector and the Chromeleon server may be interrupted. Check the USB connection. The power supply to the detector may be interrupted. Check the power supply connection of the detector.
Error opening FLD-3100 @USB-1610103 – The System cannot find the file specified	The USB connection between the detector and the Chromeleon server may be interrupted. Check the USB connection. The power supply to the detector may be interrupted. Check the power supply connection of the detector.
Error issuing control request to FLD-3100@USB-1610103	The USB connection between the detector and the Chromeleon server may be interrupted. Check the USB connection. Check the power supply connection of the detector. Remove the detector specified in the message from the server configuration or else, select a different detector from the list of available detectors in the server configuration program.
Error reading from FLD-3100 @USB-1610103 Data error (cyclic redundancy check)	Check the USB connection. The connection to the next hub must not exceed 5 m. The overall connection length, including the hub connections must not exceed 30 m. Replace any defective USB cable or hub.
Error reading from FLD-3100 @USB-1610103	The USB connection between the detector and the Chromeleon server may be interrupted. Check the USB connection. The power supply to the detector may be interrupted. Check the power supply connection of the detector.

6.3 Operating Problems

The following table provides information about common operating problems that might occur with an UltiMate 3000 system and lists probable causes, as well as remedial actions. For more information, also see the manuals for the other modules of the UltiMate 3000 system.

Problem	Probable Cause	Remedial Action
No information appears on the detector display.	<p>The instrument is not connected to the mains.</p> <p>The power is turned off.</p> <p>The instrument is in standby mode.</p> <p>The screen brightness or contrast is not adjusted correctly.</p> <p>The fuses blow.</p> <p>Replacement fuse blows immediately.</p> <p>An error occurred in the electronic system.</p>	<p>Connect the power cord.</p> <p>Turn on the detector power.</p> <p>Press the Standby button on the front panel.</p> <p>Adjust the brightness or contrast in Chromeleon (→ page 72).</p> <p>Replace the fuses (→ page 114).</p> <p>Contact Service.</p> <p>Contact Service.</p>
Problems during control under Chromeleon	<p>There is no connection between the detector and the Chromeleon computer.</p> <p>The USB port on the computer is not ready for operation.</p>	<p>Check the USB cable and connection to the computer.</p> <p>Check the USB port on the computer. It must comply to the USB 1.1 standard.</p>
No flow	<p>The system is leaking.</p> <p>There is a gas bubble in the flow path.</p> <p>For further causes, refer to the Operating Instructions of your pump.</p>	<p>Find and eliminate the leak.</p> <p>Perform a wash cycle (→ <i>Autosampler Manual</i>). Non-degassed wash solution is used. Degas the wash solution (→ <i>Autosampler Manual</i>).</p>
The system has very high backpressure.	<p>Fluidic parts in the system (capillaries, filter, column) are blocked by precipitate, or capillaries are damaged by bending.</p>	<p>Check the capillaries in the system step by step from the detector to the pump, remove the blockage, or replace the capillaries.</p>

Problem	Probable Cause	Remedial Action
Analysis run takes a long time to start or does not start at all.	The flow cell is still being preheated.	Check the set flow cell temperature. At high flow rates, the flow cell may not reach the desired temperature. Select a lower temperature.
Strong noise, non-periodic baseline fluctuation/ the Raman S/N value cannot be met	The eluent is dirty or their purity is insufficient. The detector is defective. The lamp is too old. Incorrect signal parameters were selected. The flow cell is contaminated. The water is degraded.	Use fresh eluent. Use fluorescence-grade eluents only. Contact Service. Contact Service. Also observe the guidelines for optimizing the parameters (→ page 81). Select suitable wavelengths (→ page 78). Flush the flow cell (→ page 109). Use fluorescence-grade water.
Periodic baseline fluctuation, pulsation	There are pressure fluctuations from the pump. There are air bubbles in the system.	Purge the pump; check general function (→ <i>Pump Manual</i>). Purge the system. (→ <i>Pump Manual</i>).
Peak tailing	Too large extra column volume There are bad capillary connections. Flow cell input and output are exchanged.	Use short capillary connections with a suitable inner diameter. Use different capillaries, for example, Viper capillaries. Verify that the flow cell input and output are connected correctly.
Vertical lines in peak	The detector had to automatically adapt the Sensitivity. The peak is marked by several lines.	Select a lower sensitivity. Check the Chromeleon Audit Trail to find out whether the Sensitivity was adjusted automatically.
Peak broadening, peak tailing, increased dead time	The inner diameter of the capillary to the detector is too large. There are bad capillary connections. Too large detector cell. The volume of the detector cell should not exceed the smallest peak volume by more than 1/10. The filter frits on the solvent lines are clogged.	Change the capillary. Use different capillaries, for example, Viper capillaries. Use a smaller volume flow cell (micro flow cell). Check the filter for permeability. Replace the filter frit if necessary (→ <i>Pump Manual</i>).

Problem	Probable Cause	Remedial Action
Peak broadening, peak tailing, increased dead time (<i>Cont'd</i>)	<p>The capillaries are clogged, or capillary connections bad.</p> <p>The sample loop is clogged.</p> <p>The proportioning valve is defective.</p> <p>The column is overloaded or contaminated.</p> <p>The solvent is degraded.</p> <p>Flow cell input and output are exchanged.</p> <p>The selected response time is too large.</p>	<p>Replace the capillaries. Use different capillaries, for example, Viper capillaries.</p> <p>Replace the needle (→ <i>Autosampler Manual</i>).</p> <p>Contact Service.</p> <p>Clean or replace the column.</p> <p>Use fresh solvent.</p> <p>Verify that the flow cell input and output are connected correctly.</p> <p>Select a suitable response time, e.g., using the Chromeleon Program Wizard (→ Fig. 31).</p>
Reproducible ghost peaks in the chromatogram.	<p>The degassing channels are contaminated.</p> <p>The solvents are degraded or dirty or their purity is insufficient.</p> <p>Contamination occurs somewhere in the system.</p>	<p>Rinse the degassing channels (→ <i>Solvent Rack or Pump Manual</i>).</p> <p>Use fresh and appropriate solvents.</p> <p>Flush the system with an appropriate solvent.</p>
Some broad ghost peaks in the chromatogram.	Late eluting peak from previous analysis.	Extend the run time. Increase the elution strength of the gradient (higher organic content). At the end of the run, flush column with strong eluent.
Spikes	<p>There are air bubbles in the flow cell.</p> <p>The detector lamp is old or not properly installed.</p> <p>Electrical interferences from other instruments.</p> <p>The column temperature is significantly above boiling point of the mobile phase.</p> <p>The flow cell temperature is near the boiling point of the mobile phase.</p>	<p>Check all fluid connections for tightness. Degas the mobile phase.</p> <p>Contact Service.</p> <p>Isolate the electrical circuit from strong current consumers. Consider using an UPS (Uninterruptible Power Supply) to filter current fluctuations.</p> <p>Install a backpressure regulator at the flow cell outlet. Install a post-column cooler (→ <i>TCC-3000RS Manual</i>).</p> <p>Turn off the flow cell heating.</p>

Problem	Probable Cause	Remedial Action
Negative peaks	<p>Sample solvent and mobile phase differ in composition.</p> <p>The fluorescence of the solute is lower than the fluorescence of mobile phase.</p> <p>The fluorescence of the substance or eluent is quenched by other components.</p> <p>Wrong polarization of the analog output interface.</p>	<p>Dissolve the sample in the mobile phase.</p> <p>Select a different wavelength pair. Use a mobile phase with less background fluorescence.</p> <p>Consider using the negative peaks for quantification.</p> <p>Check the analog output polarization.</p>
Wavelength verification fails.	<p>The flow cell is incorrectly installed.</p> <p>The wavelength calibration is not within the acceptable range.</p> <p>The flow cell is contaminated.</p> <p>The system does not meet the required conditions.</p>	<p>Verify that the flow cell is seated correctly and that the screws are tightened finger-tight.</p> <p>Perform a wavelength calibration (→ page 90).</p> <p>Flush the flow cell (→ page 109).</p> <p>Observe the conditions on page 90. If the procedure is repeatedly interrupted, contact Service.</p>
Poor peak area precision	<p>The autosampler draws air from the vial.</p> <p>There are air bubbles in the syringe or the autosampler fluidics.</p> <p>There is an air bubble in the flow path.</p> <p>The draw speed is too high.</p> <p>The gas content of the sample is too high or saturated.</p> <p>The needle is clogged or the needle tip is deformed.</p> <p>The autosampler, the injection valve, or the syringe valve is not tight.</p>	<p>There is not enough amount of sample in the vial, the needle height setting is incorrect (→ <i>Autosampler Manual</i>), or there are too many replicates.</p> <p>Flush the syringe (→ <i>Autosampler Manual</i>).</p> <p>Non-degassed wash liquid is used. Degas the wash liquid (→ <i>Autosampler Manual</i>).</p> <p>Perform a wash cycle (→ <i>Autosampler Manual</i>).</p> <p>Reduce the draw speed (→ <i>Autosampler Manual</i>).</p> <p>Reduce the draw speed (→ <i>Autosampler Manual</i>).</p> <p>Degas the sample if possible.</p> <p>Replace the needle (→ <i>Autosampler Manual</i>).</p> <p>→ <i>Autosampler Manual</i></p>

Problem	Probable Cause	Remedial Action
<p>Poor peak area precision (Cont'd)</p>	<p>Carry-over occurs in the system.</p> <p>The capillary connections are not installed properly or they are not tight.</p> <p>There are dead volumes in the capillary connections.</p> <p>The piston seals are not tight.</p> <p>There is air in the working head.</p> <p>There is pump pulsation.</p> <p>The gradient is irreproducible.</p> <p>The sample is unstable and decomposes.</p> <p>Baseline fluctuations</p> <p>The wrong emission wavelength was selected, e.g., in a UV spectrum flank.</p> <p>The selected response time is too small.</p> <p>The environmental conditions are unstable.</p> <p>Contamination occurs somewhere in the system.</p> <p>The detector had to automatically adapt the Sensitivity.</p>	<p>Flush the needle using an appropriate solvent (→ <i>Autosampler Manual</i>).</p> <p>Check and tighten the capillary connections. Exchange the needle seat if necessary (→ <i>Autosampler Manual</i>). Exchange the needle if necessary (→ <i>Autosampler Manual</i>).</p> <p>Replace the fittings. Make sure that the capillaries are installed correctly. Thermo Fisher Scientific recommends using Viper capillary connections whenever possible.</p> <p>Replace the seals (→ <i>Pump Manual</i>).</p> <p>Purge the pump; check general function (→ <i>Pump Manual</i>).</p> <p>Use degassed solvents.</p> <p>Change the gradient. Check the pump function and degassing. Check the filter frits in the solvent lines for contamination and replace as necessary.</p> <p>Use new sample or change the conditions. Cool the sample in the autosampler.</p> <p>see "Periodic baseline fluctuations, pulsation"</p> <p>Choose an emission wavelength which is located near the apex of the spectrum. A wavelength switch might be required.</p> <p>Select a suitable response time, e.g., using the Chromeleon Program Wizard (→ Fig. 31).</p> <p>Make sure that the temperature and air humidity are constant. Use column thermostating and/or flow cell thermostating. Avoid draft.</p> <p>Flush the system with an appropriate solvent.</p> <p>Select an appropriate Sensitivity. Check the Chromeleon Audit Trail to find out whether the Sensitivity was adjusted automatically.</p>

7 Service

7.1 General Notes and Safety Precautions

The following sections describe all procedures for the detector that the user may perform. All other maintenance and service procedures must be performed only by Thermo Fisher Scientific service personnel.

 **Warning:** The fluid components of the device may be filled with solvents that are harmful to health. Wear appropriate personal protective equipment. Rinse the fluid components with an appropriate solvent to remove harmful substances.

For information about the proper handling of a particular substance and for advice on specific hazards, refer to the material safety data sheet for the substance you are using. Observe the guidelines of Good Laboratory Practice (GLP).

 **Avertissement:** Les composants fluidiques de l'instrument peuvent être remplis de solvants nocifs. Portez l'équipement de protection personnel approprié. Rincez les composants fluidiques avec un solvant approprié afin d'éliminer les substances nocives.

Pour les informations sur la manipulation correcte des composés et des recommandations pour les situations de risque spécifiques, veuillez consulter la fiche de données de sécurité des substances que vous utilisez. Veuillez respecter des directives des Bonnes Pratiques de Laboratoire (BPL).

Before starting maintenance or service procedures, observe the following precautions:

- For all service and repair procedures, observe all precautionary statements provided in these operating instructions.
- Use only the original spare parts and accessories authorized for the device by Thermo Fisher Scientific.
- Before returning the detector for repair, contact the Thermo Fisher Scientific Service for Dionex HPLC products. An RMA (Return Material Authorization) number is required in order to track your instrument. Always use the original packaging and observe the packing instructions when shipping the module. Shipping the module in anything other than the original packaging voids the warranty.

If the original shipping container is not available, appropriate shipping containers and packing material can be ordered from Thermo Fisher Scientific sales organization for Dionex HPLC products. The packing instructions are included in the "Installation and Qualification Documents for Chromatography Instruments" binder and are available on request.

For instructions on shutting down the detector, see page 93.

7.2 Lamp

The lamp must be replaced only by Thermo Fisher Scientific Service for Dionex HPLC Products. Never try to exchange the lamp or open the enclosure yourself.

You can monitor the lamp age. This function can help to decide when a lamp is due to be replaced.

Lamp Age

 **Tip:** You can extend the lifetime of the Xenon lamp to about four times the lifetime compared to **Standard** mode by switching to **LongLife** mode. However, note that sensitivity is roughly halved.

On the basis of the number of lamp flashes, Chromeleon calculates a value that indicates how many hours the lamp was operated. The value is based on the assumption that the lamp was operated in **Standard** mode. For the calculation of the expected lamp lifetime, one operating hour is weighted depending on the selected lamp mode.

Mode	1 operating hour is counted as ...	Expected lamp lifetime
LongLife	0.25 hours	approx. 16000 hours
Standard	1 hour	approx. 4000 hours
HighPower	3 hours	approx. 1300 hours

Example: If the lamp age in Chromeleon indicates 2000 hours, this means that the lamp has reached about the half of its lifetime. Thus, if the lamp is operated in **LongLife** mode, it is expected to operate for another 8000 hours.

1. Open the **Commands** dialog box for the detector.
2. Select the **EffectiveLampAge** parameter. If the value exceeds 4000 hours, the lamp should be replaced by Thermo Fisher Scientific Service for Dionex HPLC Products.

7.3 Flow Cell

7.3.1 Flushing the Flow Cell

Flush the flow cell when you suspect that eluent or sample components may have deposited on the cell walls. Complete the following steps:

1. Flush the flow cell with HPLC-grade water.
2. Flush the flow cell with 0.1M nitric acid for 10 minutes.



Warning:

To avoid damage to the skin and eyes, wear appropriate protective clothing and glasses when cleaning the flow cell with nitric acid.



Avertissement:

Afin d'éviter des brûlures cutanées ou oculaires, portez des vêtements de protection appropriés et des lunettes de protection lorsque vous utilisez de l'acide nitrique.

3. Flush the flow cell with HPLC-grade water until the solvent leaving the cell is neutral (pH 7).
4. If cleaning the flow cell does not eliminate the problem, install a new flow cell.

7.3.2 Replacing the Flow Cell

Observe the following when removing or installing a flow cell:

 **Warning:** Flow cells can become extremely hot during operation. To avoid possible injury, allow sufficient time for the flow cell to cool down before replacing the cell.

 **Avertissement:** Au cours du fonctionnement, les cellules peuvent être extrêmement chaudes. Afin d'éviter de possibles brûlures, laissez la cellule refroidir pendant une période suffisamment longue.

- Observe the precautionary statements in section 7.1 (→ page 107).
- If no flow cell is installed, the lamp turns off automatically.
- No tools are required to remove and install a flow cell.
- The contacts for the flow cell identification chip and the temperature control are located on the rear of the flow cell. To ensure proper functionality, be careful not to touch the sensitive electronics. If liquid comes into contact with the electronics, dry it immediately.
- Capillary connections between the column and flow cell should be as short as possible to avoid peak broadening effects due to excessive dead volume.
- The backpressure on the flow cell must not exceed 20 bar (analytical flow cell) or 40 bar (micro flow cell). Do not connect any capillaries or instruments to the flow cell out line as this might generate a higher backpressure. Even if the pressure exceeds the upper limit for a very short time only, the flow cell may be permanently damaged. If it is required to connect a valve at the flow cell outlet, the valve may only be switched while the flow is stopped. When switching valves while the flow is turned on, pressure peaks may occur and destroy the flow cell. Thermo Fisher Scientific recommends using a capillary or tube with an internal diameter of at least 0.5 mm at the flow cell out line.,

The following flow cells are available for the detector:

Part no.	Description
6078.4230	Analytical flow cell <i>For details about the flow cell, see page 117.</i>
6078.4330	Micro flow cell <i>For details about the flow cell, see page 117.</i>

7.3.2.1 Removing the Flow Cell

1. Stop the pump flow.
2. Open the front panel door and disconnect the capillaries from the cell inlet and outlet connection ports, if applicable. Close the flow cell inlet and outlet with the dummy plugs that were installed when the flow cell was shipped.
3. Loosen the two flow cell screws (→ Fig. 38) until they are loose but *not* unscrewed completely. The screws are captive in the flow cell and do not need to be removed.

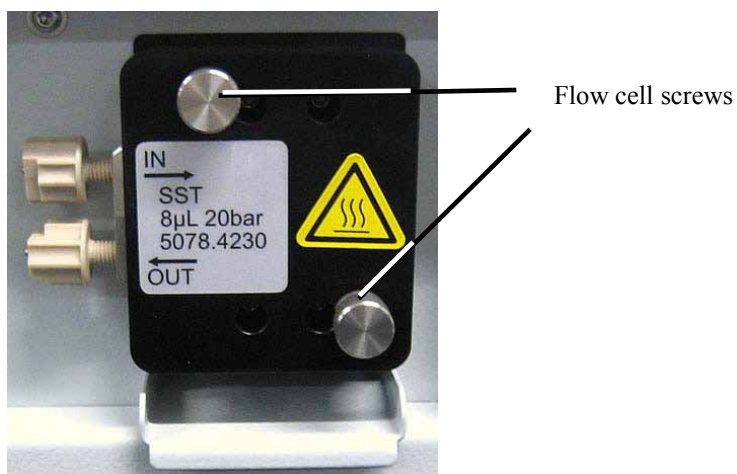

Fig. 38: Loosening the flow cell screws

4. Remove the flow cell from the optical bench.

i **Tip:** You can flush the flow cell by using the optional syringe injection/flushing kit (part no. 6078.4200).

7.3.2.2 Installing the Flow Cell

1. Insert the flow cell straight into the cell opening.



Fig. 39: Inserting the flow cell

2. Tighten the flow cell screws (→ Fig. 38) hand-tight.
3. Remove the dummy plugs on the flow cell in and out connection ports. Reconnect the flow cell inlet to the separation column and reconnect the waste capillary to the flow cell outlet. Route the capillaries to the outside through the slots provided in the detector enclosure to prevent them from being pinched when the front panel door is opened.
4. Close the front panel door to allow the firmware to detect the new flow cell.
5. Perform a wavelength calibration (→ page 90).

7.4 Drying the Leak Sensor

The leak sensor is installed inside the detector and reports a leak when liquid collects in the drip tray under the fluid connections. Eliminate the cause for the leakage and dry the leak sensor.

1. Turn off the detector.
2. Inspect the flow cell for signs of leakage. If the flow cell is leaking, tighten the connections to the flow cell. If necessary, replace the flow cell (→ page 110).
3. With a cloth or tissue, absorb all liquid that has collected in the tray.

⚠ Important: Make sure that you do not bend or damage the sensor.

⚠ Important: Assurez-vous que vous ne tordez, ni n'endommagez le capteur.



Fig. 40: Drying the leak sensor

4. Allow the sensor to adjust to the ambient temperature for a few minutes.
5. Turn on the detector.
6. If no error is reported after turning on the detector, operation can be resumed.

i Tip: If the sensor is not dry, the **Status** LED remains red. If a message appeared on the front panel display, select **Clear** on the navigation bar to remove the message from the display.

7.5 Replacing the Main Power Fuses

STOP Warning: Turn off the main power switch. Disconnect the power cord from its source.

STOP Avertissement: Avant de remplacer les fusibles, arrêtez le détecteur. Assurez-vous de bien débrancher le cordon d'alimentation de la source secteur.

1. Remove the fuse cartridge by using a small screwdriver.



Fig. 41: Fuse cartridge

2. Replace the fuses.

STOP Warning: Always install two new fuses. Use only the fuses indicated in the following table.

STOP Avertissement: Installez toujours deux nouveaux fusibles.
Utilisez uniquement les fusibles indiqués ci-dessous.

Description	Part no.
Überlastsicherung, 2A, träge, 5 x 20 mm	Included in Fuses Kit (part no. 6074.0005) For information about the kit, see section 9.3 (→ page 121).

3. Reinstall the fuse cartridge.
4. Reconnect the power cord to its source. Turn on the detector power.

7.6 Updating the Detector Firmware

The detector is shipped with the most recent firmware version. The detector firmware is also included in Chromeleon.

To check which firmware version is installed in the detector and which version is included in Chromeleon:

- *Firmware version installed in the detector*
 - Turn on the detector by pressing the power switch on the rear of the detector. General information about the detector appears on the display, including the firmware version.
 - On the detector display, select the **Diagnostics** menu (→ page 63), and then select **System**. The current firmware version is displayed under **Firmware version**
- *Firmware version in Chromeleon*
 - In the **Server Configuration** program, open the configuration pages for the detector (→ page 40). On the **General** page, the firmware version is displayed.
 - In the Windows Explorer, locate the **IQReport.log** file in the **IQ** folder of your Chromeleon installation. In the file, search for FLD-3000.hex.

 **Tip:** When updating the firmware via Chromeleon, this information will also be provided during the download (see below).

Whenever a new firmware version is released for the detector, the new version will be provided with the next Chromeleon Service Release and described in the related release notes.

The new firmware will not be downloaded automatically to the detector when you install a Chromeleon Service Release. To update the firmware in the detector, follow the steps below:

 **Important:** To ensure that the download is successful, make sure that the communication between the detector and Chromeleon is *not* interrupted during the download and do *not* turn off the detector.

 **Important:** Au cours du téléchargement, assurez-vous que la communication entre la pompe et Chromeleon n'est pas interrompue et n'arrêtez pas l'instrument. Ceci peut entraîner des dysfonctionnements de l'instrument.

1. Before you begin, verify that
 - ◆ The detector is connected with Chromeleon.
 - ◆ The Chromeleon server is in *running idle* mode. This means that all processes on the Chromeleon server PC and in Chromeleon have been stopped.
2. Start the **Server Configuration** program (→ page 39).

3. Right-click the detector in the timebase and select **Properties** on the menu.
4. On the **General** page (→ page 40), the firmware version provided by Chromeleon for the detector is displayed in the **Firmware** field. If more than one firmware version is available for the detector in Chromeleon, select the version from the **Firmware** list.
5. Click **Download**. A message displays the firmware version that is currently installed in the detector and the version that will be downloaded from Chromeleon.

 **Tip:** If the detector comes with a newer firmware than the version included in Chromeleon, do *not* downgrade the firmware. Older firmware may be incompatible with new hardware revisions.

6. Click **Yes** to start the download. (Click **No** to cancel the action.)

The download may take several minutes. The download is complete when **Download finished successfully** appears in the **Messages Server** window in the Chromeleon Server Configuration program. The message appears also in the Chromeleon Audit Trail.

If the download is not successful, the related messages appear in the Audit Trail. In this case, turn off the detector. Turn on the detector again and repeat the download as described above. If the download fails again, contact Service.

8 Technical Information

Specification	FLD-3100	FLD-3400RS
Optical Design:	Two monochromators with concave holographic gratings and hyperbolic mirrors for highest efficiency in light transmission	
Light source:	Xenon flash lamp (15W); Three different flash frequencies (HighPower, Standard, LongLife) can be selected.	
Reference system:	Reference diode behind flow cell for compensation of lamp intensity fluctuations	
Data collection rate:	Adjustable, max. 100 Hz	Adjustable, multi-channel: max. 4 Hz single-channel: max. 100 Hz (Chromeleon 6.80) or 200 Hz (Chromeleon 7.1 or later)
Spectra scanning modes:	2D scans: Excitation, Emission, Synchro Under Chromeleon 7.1 or later: 3D scans: Excitation, Emission, Synchro	
Wavelength range:	Ex Min: 200 nm Ex Max: 630 nm (with Dual-PMT: 880 nm) Em Min: 265 nm Em Max: 650 nm (with Dual-PMT: 900 nm)	Ex Min: 200 nm Ex Max: 630 nm (with Dual-PMT: 880 nm) Em Min: 220 nm Em Max: 650 nm (with Dual-PMT: 900 nm)
Spectral bandwidth:	Excitation: 20 nm Emission: 20 nm	
Programmable filter wheel:	No (280 nm fixed)	Yes, 5 positions (280 nm, 370 nm, 435 nm, 530 nm, Open)
Number of channels:	1	Up to 4
Excitation/emission wavelength switching time:	< 250 ms	
Wavelength accuracy:	± 2 nm (over detector lifetime)	
Wavelength repeatability:	± 0.2 nm	
Sensitivity:	Raman signal-to-noise ratio: >550 ASTM over the over the entire lifetime of the lamp (>2100 with dark current as reference)	
Infrared option:	A Dual-PMT Option for the near infrared region (up to 900 nm) may be installed, without any loss in sensitivity in the UV spectral region.	
Flow cell temperature control	Ambient 15 °C to 50 °C	

Specification	FLD-3100	FLD-3400RS										
Flow cells:	<p><u>Analytical standard flow cell:</u> Cell volume: 8 µL; pressure limit: 20 bar Wetted parts: carbon reinforced PTFE, fused silica, stainless steel</p> <p><u>Micro flow cell:</u> Cell volume: 2 µL; pressure limit: 40 bar Wetted parts: carbon reinforced PTFE, fused silica, stainless steel</p> <p>Identification of flow cell type and serial number by mean of an built-in ID chip.</p>											
Control:	All parameters and functions software controlled, USB 1.1 3 LEDs (Power, Connected, Status) for status monitoring											
Analog outputs:	<p>2 analog outputs via optional plug-in board to output fluorescence channels</p> <p>Resolution 20 Bit, maximum data rate 50 Hz, outputs can be configured via software (output voltage range 0 to 1 V or 0 to 10 V, sensitivity and offset)</p>											
GLP features:	<p>In Chromeleon: Full support of automatic equipment qualification (AutoQ™) and system performance monitoring All system parameters are logged in the Audit Trail.</p>											
User input/display:	<p>LCD indicating system parameters Standby button 3 LEDs (Power, Connected, and Status) for status monitoring Menu functions for maintenance</p>											
Safety features:	<p>Power-up diagnostics of optics, cooling fans, motors, and electronics Leak sensor</p>											
Power requirements:	85-260 V AC, 50/60 Hz, max. 150 W											
Emission sound pressure level:	< 70 dB(A), typically 54 dB(A)											
Environmental conditions:	<table> <tr> <td>Range of use:</td> <td>Indoor use</td> </tr> <tr> <td>Temperature:</td> <td>10 °C to 35 °C (50 to 95°F)</td> </tr> <tr> <td>Air humidity:</td> <td>80% relative humidity, non-condensing</td> </tr> <tr> <td>Overvoltage category:</td> <td>II</td> </tr> <tr> <td>Pollution degree:</td> <td>2</td> </tr> </table>		Range of use:	Indoor use	Temperature:	10 °C to 35 °C (50 to 95°F)	Air humidity:	80% relative humidity, non-condensing	Overvoltage category:	II	Pollution degree:	2
Range of use:	Indoor use											
Temperature:	10 °C to 35 °C (50 to 95°F)											
Air humidity:	80% relative humidity, non-condensing											
Overvoltage category:	II											
Pollution degree:	2											
Dimensions (h × w × d):	16 × 42 × 51 cm (6.3 × 16.5 × 20 in.)											
Weight:	Approx. 18 kg (approx. 39.7 lbs)											

Technical information: September 2013

All technical specifications are subject to change without notice.

9 Accessories, Consumables, and Spare Parts

Accessories, spare parts, and consumables for the detector are always maintained at the latest technical standard. Therefore, part numbers are subject to alteration. However, updated parts will always be compatible with the parts they replace.

9.1 Standard Accessories

The following standard accessories are shipped with the detector.

The part number always refers to the packing unit. Unless otherwise stated, the packing unit is 1 unit. For more information, contact the Thermo Fisher Scientific sales organization for Dionex HPLC Products.

Description	Part no.	Quantity in the accessories kit
FLD-3100 and FLD-3400 accessories kit, including:		
Fuses kit for FLD (10 fuses, 2A, slow-blow, 5 x 20 mm)	6074.0005	2
Tee piece for drainage system	Included in 6040.0005	1
USB cable type A to type B, 5m	6911.0002	1

9.2 Optional Accessories

Description	Part no.	Remarks
Analytical flow cell <i>For details about the flow cell, see page 117.</i>	6078.4230	For installation details, see page 48.
Micro flow cell <i>For details about the flow cell, see page 117.</i>	6078.4330	For installation details, see page 48.
Flow cell syringe injection/flushing kit	6078.4200	Kit with syringe and capillaries for direct injection into a flow cell.
DAC board	6078.0305	Provides two analog outputs on the rear panel. For installation information, refer to page 34.
Drain system kit for UltiMate 3000 systems	6040.0005	The kit includes all required components and detailed installation instructions
Menu pen	6300.0100	
Dual-PMT option	Contact service.	Upgrade kit for FLD detectors with a single PMT. Installation must be performed by the Thermo Fisher Scientific Service for Dionex HPLC Products.

9.3 Consumables and Spare Parts

The part number always refers to the packing unit. Unless otherwise stated, the packing unit is 1 unit. For more information, contact the Thermo Fisher Scientific sales organization for Dionex HPLC Products.

Description	Part no.
Capillary (PEEK, 1/16" x 0.25 mm OD x ID, 1 m)	6251.6001
Capillary (PEEK, 1/16" x 0.50 mm OD x ID, 1 m)	2251.6002
Capillary from TCC to FLD (0.13 mm x 250 mm ID x L, SST, Viper), including appropriate fitting connections	6040.2325
Capillary from TCC to FLD (0.18 mm x 250 mm ID x L, SST, Viper), including appropriate fitting connections	6040.2385
DAC board	6078.0305
Drain system kit for UltiMate 3000 systems	6040.0005
Flow cell syringe injection/flushing kit	6078.4200
Flow cell, analytical <i>For details about the flow cell, see page 117.</i>	6078.4230
Flow cell, micro <i>For details about the flow cell, see page 117.</i>	6078.4330
Fuses kit for FLD (10 fuses, 2A, slow-blow, 5 x 20 mm)	6074.0005
Menu pen	6300.0100
One-piece fitting, handtight	6200.5502
Power cord, Australia, China	6000.1060
Power cord, Denmark	6000.1070
Power cord, EU	6000.1000
Power cord, India/SA	6000.1090
Power cord, Italy	6000.1040
Power cord, Japan	6000.1050
Power cord, Switzerland	6000.1030
Power cord, UK	6000.1020
Power cord, US	6000.1001
USB cable, type A to type B, high speed USB 2.0 (cable length: 1 m)	6035.9035
USB cable, type A to type B, high speed USB 2.0 (cable length: 5 m)	6911.0002

10 Appendix: Common Mobile Phases

The mobile phase composition affects its UV cutoff, that is, the minimum effective wavelength for the measurement. In general, mobile phases are solvents, such as, water, acetonitrile, methanol, or other substances. They may also contain salts, such as NaOH.

If the excitation monochromator of a fluorescence detector is set below the UV cutoff of the mobile phase, the solvent will absorb some of the excitation light. Thus, the excitation wavelength should always be above the UV cutoff of the solvent (recommendation: min. 30 nm).

The UV cutoff wavelengths of these solvents may differ from those predicted by Table 1. Among other factors, the degassing quality and purity grade of the solvent affect the UV cutoff. Therefore, the values listed below are approximate values only. The cutoffs listed in the table apply to HPLC-grade solvents.

Solvent	UV Cutoff (nm)	Refractive Index	Selectivity Group
Acetic acid	208	1.37	IV
Acetone	330	1.356	VIa
Acetonitrile	190	1.341	VIb
Dioxane	215	1.42	VIa
Ethanol	210	1.359	II
Ethyl acetate	256	1.37	VIa
Hexane sulfonic acid (0.005 M)	230		
Methanol	205	1.326	II
Methylene chloride	233	1.421	V
n-Hexane	190	1.372	VII
Octane sulfonic acid	230		
Sodium carbonate (0.01 M)	210		
Sodium hydroxide (0.1 M)	217		
Tetrabutylammonium hydroxide (0.005 M)	215		
Tetrahydrofuran	212	1.405	III
Tetrapropylammonium hydroxide	195		
Toluene	285	1.494	VII
Triethylamine		1.398	I
Water		1.333	VIII

Table 1: Properties of frequently used mobile phases

E	I
Emission Monochromator 17	Infrared Detector 19
Emission Scan..... 75	Installation
Emission Wavelength 78	Connections 32
Equilibration 51	In Chromeleon 37
Equilibration (SmartStartup Wizard) 51	In DCMSLink 44
Equilibration Program 51	Site 29
Error Messages 98	System Setup 31
Excitation Monochromator 16	Unpacking 30
Excitation Scan 74	Intended Use 12
Excitation Wavelength 78	Interior Components 20
F	L
Filter Wheel 85	Lamp 25, 108
Firmware Download 41, 115	Lamp Mode 88
Firmware Update 115	Replace 108
Firmware Version 116	Lamp Age 108
FLD Type 42	Leak Detection 72
Flow Cell 53, 109	Leak Sensor 25, 72, 113
Flush 109	Leak Sensor Mode 62, 72
General 24	Lifetime (Lamp) 108
Install 48	Limit of Detection 77
Notes 53	
Remove 111	M
Replace 110	Main (Menu) 61
Volume 24	Maintenance 95
Flow Cell Temperature 88, 92	Maintenance Intervals 95
Flow Cell Types 24	MaxPMT Saturation 82
Fluid Connections 23	Menu 58
Fluorescence 16	Configuration 62
Fluorescence Intensity 77	Diagnostics 63
Found New Hardware Wizard 38	Layout 59
Front Panel Elements 21	Main 61
Function Key	Overview 58
Arrow Down 59	Service 63
Arrow Up 59	Show 57
Back 59	Menu Key 57
Cancel 60	Messages 98
Clear 60, 98	Method Development 78
Next 60, 98	Mobile Phase 52, 123
Ok 60	Module Address 41
Prev 60, 98	Multi-Channel Mode 73
Select 59	Multi-Channel Performance 87
Toggle 60	Multiple Wavelength 73, 87
Fuse Cartridge 22	
Fuse Replacement 114	N
G	Negative Peaks 105
General (Dialog Box) 40	Noise 77, 103
Ghost Peaks 104	Not Calibrated Message 90

O	<p>Ok 60</p> <p>Operating Hours (Lamp)..... 108</p> <p>Operating Instructions..... 1</p> <p>Operating Principle 16</p> <p>Operating Problems 102</p> <p>Operation 55</p> <p style="padding-left: 20px;">Chromleon..... 64</p> <p style="padding-left: 20px;">Control Elements 21</p> <p style="padding-left: 20px;">Detector Display 57</p> <p style="padding-left: 20px;">General..... 52</p> <p style="padding-left: 20px;">Menu 58</p> <p style="padding-left: 20px;">Power-Up 55</p> <p style="padding-left: 20px;">Safety Precautions..... 5</p> <p>Operational Qualification 92</p> <p>Optics 16</p> <p>Optimization 77</p> <p>Optimum Wavelength..... 78</p>	<p>Response Time 86</p> <p>RMA Number 107</p>
P	<p>Panel Tabset..... 66</p> <p>Peak Tailing 103</p> <p>Performance Optimization..... 77</p> <p>Performance Qualification..... 92</p> <p>Photomultiplier Tube (PMT) 17</p> <p>PMT 17</p> <p>Power Connection..... 34</p> <p>Power Switch..... 22</p> <p>Power-Up..... 55</p> <p>Precision 105</p> <p>Predictive Performance 27, 92</p> <p>Preparation</p> <p style="padding-left: 20px;">Actions 45</p> <p style="padding-left: 20px;">Install Flow Cell..... 48</p> <p style="padding-left: 20px;">System Equilibration..... 51</p> <p>Program</p> <p style="padding-left: 20px;">Create 67, 70</p> <p style="padding-left: 20px;">Equilibration 51</p> <p style="padding-left: 20px;">Shutdown 93</p> <p style="padding-left: 20px;">Standby 93</p> <p>Program Start..... 71</p> <p>Program Wizard..... 68</p> <p>Pulsation 103</p>	<p style="text-align: center; vertical-align: top;">S</p> <p>Safety 3</p> <p>Safety Precautions 5</p> <p>Scans</p> <p style="padding-left: 20px;">2D 74</p> <p style="padding-left: 20px;">3D 76</p> <p>Select 59</p> <p>Sensitivity 81</p> <p>Server Configuration Program..... 39</p> <p>Server Monitor 39</p> <p>Service</p> <p style="padding-left: 20px;">Firmware Update 115</p> <p style="padding-left: 20px;">Flow Cell 110</p> <p style="padding-left: 20px;">Fuse Replacement..... 114</p> <p style="padding-left: 20px;">General Notes 107</p> <p style="padding-left: 20px;">Lamp..... 108</p> <p style="padding-left: 20px;">Leak Sensor 113</p> <p style="padding-left: 20px;">Notes..... 107</p> <p style="padding-left: 20px;">Safety Precautions 107</p> <p>Service Menu..... 63</p> <p>Shut Down 93</p> <p>Shutdown Program 93</p> <p>Signals (Dialog Box)..... 43</p> <p>Single-Channel Mode..... 73</p> <p>SmartShutdown 71, 94</p> <p>SmartStartup..... 51, 71</p> <p>Soft Keys 57</p> <p>Solvent Delivery System 53</p> <p>Spare Parts 121</p> <p>Specification..... 117</p> <p>Spectra Scanning (2D)..... 74</p> <p>Spectra Scanning (3D)..... 76</p> <p>Spikes 104</p> <p>Standby Program 93</p> <p>Startup</p> <p style="padding-left: 20px;">Actions..... 45</p> <p style="padding-left: 20px;">System Equilibration 51</p> <p>Status Indicator..... 55</p> <p>Symbols..... 3</p> <p>Synchro Scan..... 75</p> <p>System Connections 31</p> <p>System Drainage..... 47</p>
R	<p>Rear Panel..... 22</p> <p style="padding-left: 20px;">Analog Outputs 23, 34</p> <p style="padding-left: 20px;">Fuse 22</p> <p style="padding-left: 20px;">Power Switch 22</p> <p style="padding-left: 20px;">USB..... 23, 32</p> <p>Reference Detector 16</p> <p>Reset to Factory Defaults..... 62</p>	<p style="text-align: center; vertical-align: top;">T</p> <p>Technical Information 117</p> <p>Temperature Channel 92</p> <p>Toggle..... 60</p> <p>Troubleshooting..... 97</p> <p style="padding-left: 20px;">Messages..... 98</p> <p style="padding-left: 20px;">Operating Problems 102</p>

