

Advanced Performance UniBloc Balances

# AP Series





\*AP225W-AD

AP W-AD

# AP with Automatic Door

## AP W-AD Series

Advanced Performance UniBloc™ Balances

Provides High-Speed Response and High Stability

New automatic door functionality makes weighing operations even more convenient

01 Touchless sensors and Smart Auto Door improve hygiene and lower contamination risk to provide a superior operating environment.

02 An ionizer and adjustable windbreak plate reduce static electricity and convection effects to provide highly stable and reliable measurements.

03 LabSolutions™ Balance supports weighing data integrity.



Visit our website for more information.

Product



# AP with Automatic Door

AP W-AD Series

## Smart Auto Door Improves Work Efficiency

The AP series features automatic doors. That means operators can continue working without setting down samples or spatulas, which can help shorten overall measurement times.

### Doors Open/Close Smoothly and Quickly

Door opening/closing time is about one second. The quick and smooth door action enables stress-free operation.

### Adjustable Opening/Closing Distance Using Automatic Learning Functionality

The automatic doors include automatic learning functionality that enables freely setting how far to open/close each glass door. That minimizes external air effects and increases operational efficiency.



### Doors can be opened/closed by three methods, depending on preference.

- 1 Open/close by waving a hand over the left and right infrared sensors

That enables door operation without touching the balance.

- 2 Open/close by pressing the left and right buttons on the front

That allows opening/closing doors with a satisfying click sensation.

- 3 Open/close using the manual trigger function

The glass doors open/close automatically after the doors are moved about 10 mm. That enables intuitive door operation.

### More Extensive Commands for Production Line Applications

#### ■ Computer-Controlled Door Open/Close Operation

This is ideal for managing very small measurement quantities, such as for controlling coating quantities applied on a production line.

#### ■ More Commands Compatible with Non-Shimadzu Brands

The list of commands that support opening/closing doors, acquiring weighing data, or other actions on non-Shimadzu products has been expanded. That means existing programs can be used more effectively.

| Command | Function  |
|---------|---|
| WS0     | Closes top, left, and right doors (all three doors) |
| WS1     | Opens the right door                                |
| WS2     | Opens the left door                                 |
| SI      | Acquires weighing data                              |
| T       | Subtracts tare weight                               |
| ESC w1_ | Opens the left door                                 |
| ESC w2_ | Closes top, left, and right doors (all three doors) |
| ESC w3_ | Opens the top door                                  |
| ESC w4_ | Opens the right door                                |
| ESC P   | Acquires weighing data                              |
| ESC U   | Subtracts tare weight                               |

### Suppresses the Effect of Convections

AP series have optional parts around the weighing pan (shield case\*, stage\* and adjustable windbreak plate\*). These features suppresses the influence of convection and airflow within the weighing chamber to improve the stability and response of measurement values.

If weighing papers, microtubes, or other items are used for measuring, use the optional multi-stand accessory.

\* Included standard with 0.01 mg models of W series only.

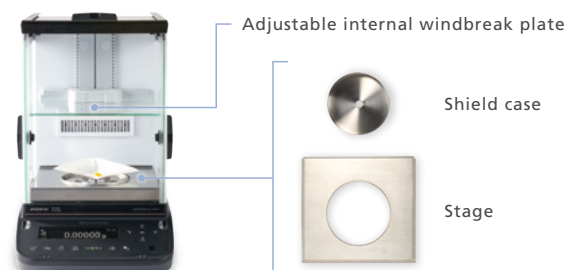

# Provides High-Speed Response and High Stability

Improved automatic door access makes weighing operations even more convenient

## Touchless Sensors Enable Hygienic Operation

The balance can be operated without touching the main unit.

That is especially helpful for infectious disease prevention or when handling hazardous substances.

It enables non-contact weighing operations without touching any operating keys. With the multi-function mode setting specified, a total of four different functions can be executed depending on how long hands are held over the left and right touchless sensors. That is perfect for ensuring safety by not contacting the unit when handling toxic substances and enables the balance to be operated smoothly while wearing gloves.

Checking the status of function settings by holding hands over both touchless sensors



List of Functions Learnable for Touchless Operation

| Key                                       | Function  |
|---|---|
| Door Open/Close Keys (Left and Right)<br> | Opens/closes the glass door specified using the learning function             |
| PRINT<br>                                 | Outputs weight measurement values to an external device (printer or computer) |
| O/T<br>                                   | Subtracts the tare weight (resets the zero point)                             |
| ION<br>                                   | Switches the ionizer ON/OFF   |

## Adjustable Windbreak Plate Improves Stability and Response

The windbreak suppresses factors that can cause measurement error, so that stable weighing can be performed by anyone.

Convection and air flow effects can be suppressed by minimizing the weighing chamber volume. W-AD series 0.01 mg models are equipped standard with an adjustable windbreak plate inside the main unit. It can be raised or lowered according to the various containers or samples involved to provide the optimal weighing environment.

Height is Easily Adjustable with One Hand



Height can be adjusted in 5 mm increments. Optimal conditions inside the weighing chamber can be prepared by adjusting the height based on the given containers and samples involved.



Even a specific gravity measurement kit (SMK-601) can be installed by removing the adjustable windbreak plate.

# AP with Automatic Door

AP W-AD Series

## Equipped Standard with a STABLO™-AP Ionizer

This ionizer eliminates the influence of static electricity to achieve reliable measurements without requiring tedious steps.

The STABLO-AP ionizer can eliminate static electricity on samples, containers, and other surfaces quickly and easily by pressing just one button, resulting in increased reproducibility and operational efficiency. The ionizer uses the AC method to provide superior long-term stability without worry of reverse charging. That ensures higher measurement reliability than ever before.



The adjustable windbreak plate\* and STABLO-AP ionizer are great for weighing samples in the following situations!

\* See page 5.

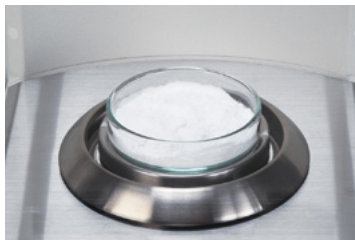

Numerical values fluctuate due to electrically charged powder in a Petri dish



Numerical values do not stabilize due to electrically charged weighing paper

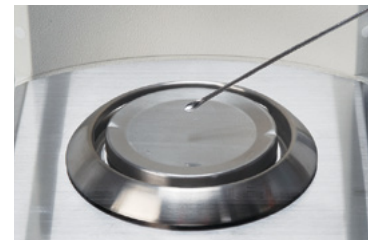

Measurement values change when an electrically charged measuring spoon is simply moved near the sample

## STABLO-AP Features

### Static Electricity Removal by Ion Irradiation

If samples or containers are prone to static charging, static electricity can cause measurement instability, particularly in analytical balances and similar instruments. The STABLO-AP achieves accurate and stable measurements by emitting an ionically well-balanced AC corona discharge to reduce static charge.

#### <Principle of Static Removal Process>

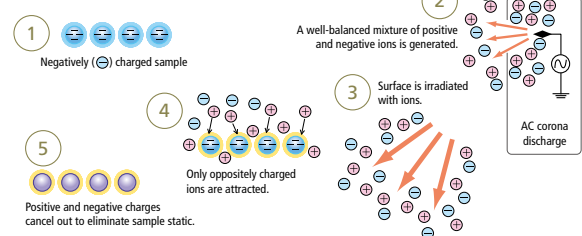

### AC Method Produces Excellent Ion Balance

**AC method:** Applies an AC current to the discharge needle to emit equal quantities of positive and negative ions from a single electrode.

**DC method:** Applies a positive or negative DC voltage to each of two electrodes to emit corresponding ions. If the electrodes are too far apart, the charge removal range is limited. Also, any deterioration of the discharge needles can result in a worse balance of ions.

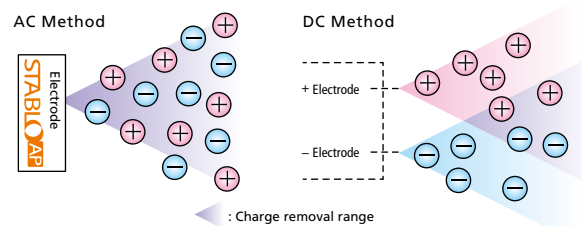



# AP Series

Advanced Performance UniBloc Balances

## High Speed

The response time for trace measurements (from 1 mg) is about 2 seconds.

This significantly improves weighing efficiency.

Automatic doors (with automatic open/close learning function) can be closed/opened in about 1 second.\*<sup>1</sup>

## Stress Free

The STABLO-AP ionizer, which can be mounted,\*<sup>1</sup> eliminates the influence of static electricity, achieving reliable measurements in a simpler procedure.

An adjustable internal windbreak plate increases stability even higher.\*<sup>2</sup>

Designed with touchless sensors that enable hygienic weighing without touching the balance.\*<sup>1</sup>

## For HPLC

Functions are included for the preparation of buffer solutions used in HPLC analysis.

As a result, operation can be performed accurately and easily, even by non-specialists.

## For Regulation

By linking with LabSolutions Balance, falsification of weighing data can be prevented and data can be managed in conjunction with analysis results such as HPLC.

## Save Your Operation

Equipped with USB as standard\*<sup>3</sup>.

Includes many diverse functions to support users.

\*<sup>1</sup> Included standard only on W-AD series models.

\*<sup>2</sup> Included standard only on W-AD series 0.01 mg models. Other models use optional internal windbreak plate. (Included standard with 0.01 mg models of W series only.)

\*<sup>3</sup> All models: USB-B type connector as standard  
W-AD/W Series: USB-A type and B type as standard



Product



Visit our website for more information.

# High Speed

Fast measurement significantly improves operational efficiency.

## Fast Response with UniBloc AP Technology

Shimadzu analytical balances boast the one-piece UniBloc weighing sensor, which is now even more advanced.

The response time is reduced to about 1/5 the time of previous models.

In addition, the UniBloc sensor offers a response time of just 2 seconds, an improvement from 10 seconds with the previous model.

Response During Trace Measurements with the 0.01 mg Model (Equivalent to 1 mg / With Conditions Set by Shimadzu)

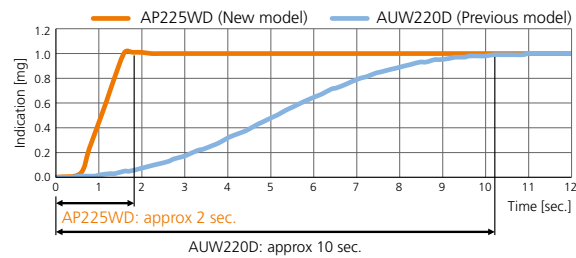

Response During Trace Measurements with the 0.1 mg Model (Equivalent to 1 mg / With Conditions Set by Shimadzu)

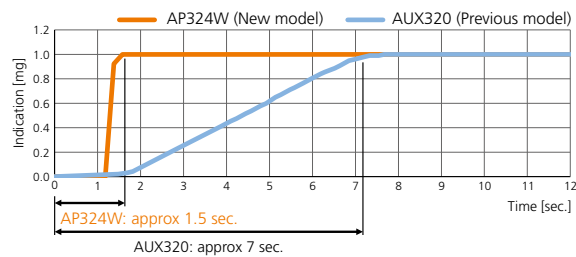

| Model   | Previous Model | AP Series |
|---------|----------------|-----------|
| 0.01 mg | 10 sec.        | 2 sec.    |
| 0.1 mg  | 7 sec.         | 1.5 sec.  |



## Built-in High-Performance Ionizer

(Built in the W-AD series, optional for the W/X series and cannot be built into the Y series.)

The ionizer eliminates the influence of static electricity in 1/10 the time of previous models.

Note: Example of typical static electricity removal time ( $\pm 1000$  V  $\rightarrow$   $\pm 100$  V); 1 sec. for STABLO-AP and 10 sec. for STABLO-EX (previous model)

Comparison of Neutralization Speed (Representative Values)

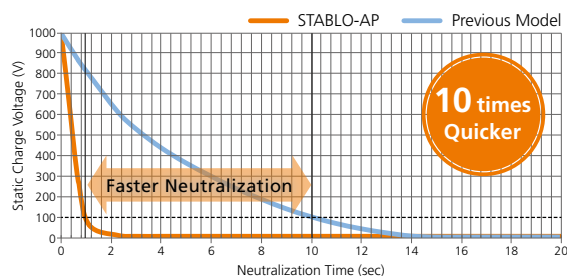

Measurement Conditions Time from  $\pm 1000$  V to  $\pm 100$  V / 100 mm distance between CPM and ionizer  
For this evaluation, a 150x150 mm charged plate monitor (CPM, 20 pF) was used.  
Distance between CPM and ionizer: 100 mm

AC Method with Excellent Ion Polarity Balance

Mount the STABLO-AP in the balance and use it as a built-in model





# Stress Free

A variety of functionalities suitable for semi-micro measurements added

## Highly Sophisticated Simulation Technology

### Increased weighing capacity from 135 mg to 220 g (0.01 mg model)

Micro amount weighing over 135 mg (read 0.01 mg step) is possible.

## Improved Sensitivity Stability When Ambient Temperature Changes

(Minimum display of 0.01 mg on AP225W-AD/135W-AD/225WD-AD/125WD-AD/225W/135W/225WD/125WD only)

The temperature of the operational environment is affected by the external air temperature, turning off the air-conditioning, people entering the room, etc.

The stability with respect to these small temperature variations in the operational environment has been improved.

When the ambient temperature has changed by +1 °C in 20 minutes, the AP225W improves the stability of the sensitivity by a factor of four compared to the previous model.

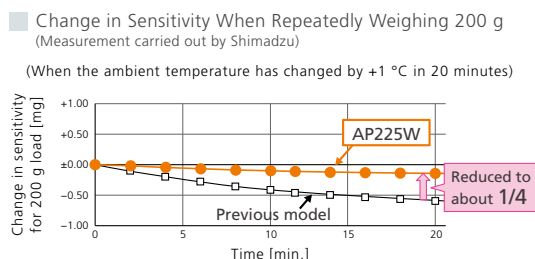

## Improved Minimum Weight

(Minimum display of 0.01 mg on AP225W-AD/135W-AD/225WD-AD/125WD-AD/225W/135W/225WD/125WD only)

By improving stability technologies, the minimum weight required for meeting USP Chapter 41 requirements has been improved from 30 mg to 20 mg.

\* In a factory test in our company

## Operational Efficiency and Measurement Reliability Improvements Due to AP Holder

The AP Holder (standard accessory for AP225W-AD and AP225W) enables weighing samples directly in volumetric flasks or other such containers. Eliminating the work involved in transferring samples to weighing paper not only improves the efficiency of weighing operations, but also prevents contamination during that transfer process.

→ The AP Holder in combination with the ionizer can eliminate the influence of static electricity on the weight value. See page 17 for more information.



Volumetric flask  
(100 mL)



AP Holder

Containers that can be used with the AP Holder (Examples)

| Container        | Applicable Volume*2 |
|------------------|---------------------|
| Volumetric flask | 10 to 100 mL        |
| Conical flask    | 100 mL              |
| Beaker           |                     |
| Centrifuge tube  | 3 to 25 mL          |
| Test tube        |                     |

\*2 About 70 mm or more height or length is required.

## Easy-to-Use Multi Stand

(W-AD Series 0.01 mg model only, equipped as standard)



With weighing paper, for example, if the tare is larger than the pan diameter, measurements can be simplified by attaching the special multi stand.

## Windbreak Plate Improves the Stability

(W Series 0.01 mg model only, equipped as standard)



The internal windbreak plate suppresses the influence of convection and air flow within the weighing chamber, improving the stability and response of measurement values.

# For HPLC

For Users of HPLC Systems



## Buffer Solution Preparation Mode (W-AD/W Series only)

- **Recipes for 13 commonly used buffer solutions are included**
- **New buffer solution recipes can be registered**

Preparation recipes for commonly used buffer solutions, e.g. disodium phosphate, sodium acid citrate, are provided.

If a buffer solution is not registered by default, it can be registered.

- **Instructions are shown on the display**

The target weighing value is shown on the display and analog bar in order to compare the target with the current weight. Manual calculation is not needed.

- **Record function**

Record output with date, time, and operator name.

The pH level of mobile phase (eluent) solutions used in liquid chromatographs is adjusted to improve the separation of components and extend the life of columns. This pH adjustment process is performed using a buffer solution.

Currently, the most common method is using a pH meter to measure the pH as the solution is prepared; however, this process requires considerable time and effort, which can cause operational bottlenecks. An alternative method does not require a pH meter. It involves preparing solutions by weighing fixed theoretically calculated quantities of an acid and base.

AP series supports weighing these acids and bases. If the type and quantity of the buffer solution are specified, the balance displays the type and quantity of sample that should be weighed. Then the buffer solution can be prepared easily by adding water to the specified quantity of sample weighed accordingly.

**Preparation Example** | When weighing and preparing 50 mM of di-sodium hydrogen phosphate, 2-hydrate and 50 mM of sodium dihydrogenphosphate, 2-hydrate in order to prepare 3 L of 100 mM phosphoric acid (sodium) buffer solution at pH=2.1:

Example of preparation by AP series

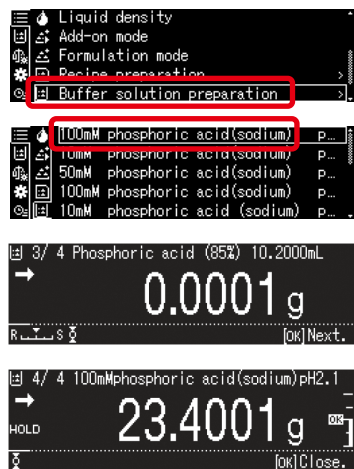

Select the buffer solution preparation mode.



Specify the type and quantity.



Displays the name and quantity of sample.



Prepare as instructed on screen.



**Complete buffer solution**

\* Results can be printed with date/time and user ID.



| Number | Buffer solution preparation list        |
|--------|---|
| 1      | 100 mM Phosphoric acid (sodium) pH=2.1  |
| 2      | 10 mM Phosphoric acid (sodium) pH=2.6   |
| 3      | 50 mM Phosphoric acid (sodium) pH=2.8   |
| 4      | 100 mM Phosphoric acid (sodium) pH=6.8  |
| 5      | 10 mM Phosphoric acid (sodium) pH=6.9   |
| 6      | 20 mM Citric acid (sodium) pH=3.1       |
| 7      | 20 mM Citric acid (sodium) pH=4.6       |
| 8      | 10 mM Tartaric acid (sodium) pH=2.9     |
| 9      | 10 mM Tartaric acid (sodium) pH=4.2     |
| 10     | 20 mM Acetic acid (ethanolamine) pH=9.6 |
| 11     | 100 mM Acetic acid (sodium) pH=4.7      |
| 12     | 100 mM Boric acid (potassium) pH=9.1    |
| 13     | 100 mM Boric acid (sodium) pH=9.1       |

# For Regulation

For Pharmaceutical Industry Customers

## High-Security User Management (All models)

Operations can be kept secure with user ID and password protection. Access rights can be specified separately for each user to prohibit unauthorized actions such as performing calibration or changing the settings. User IDs can also be used for barcode management.

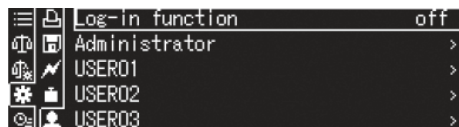

User Selection Screen

## AP\_Backup, software that can backup all User setting information, is available for free download

[Details](#)

AP\_Backup is a software that can backup and restore all User setting information of the Login function. This not only reduces the risk of losing User setting information due to malfunctions, etc., but can also be used to transfer User setting information between balances.

Note: AP\_Backup is only compatible for balances with 90 user accounts Login function (with firmware version starting with "L" or "E"). It cannot be used for balances with 10 user accounts.

## Printing Data in Accordance with Various Regulations (All models)

Printing can be customized to indicate when the values were measured and by whom. Users are free to set which items are to output, and in what order. The date, time, calibration log, and other information can be printed depending on the purpose of printing, which supports compliance with ISO, GLP, and GMP.

\*When connecting a PC and a printer (optional).

### Printed content

- Date
- Time
- User name
- User ID
- Company name
- Balance model
- Serial number
- Software version
- Balance ID
- Minimum sample quantity
- Blank line
- Ruled line (-----)

### An example of printing

|                                   |                   |
|-----------------------------------|-------------------|
| Type of sensitivity calibration   | CAL-INTERNAL      |
| Manufacturer name                 | SHIMADZU CORP.    |
| Model name                        | TYPE AP324W       |
| Serial number                     | SN 000000001      |
| Date                              | DATE 2020 July.20 |
| Time                              | TIME 15.51.55     |
| User name                         | YAMADA TARO       |
| Standard weight value             | REF= 300.0000g    |
| Weighing value before calibration | BFR= 299.9999g    |
| Weighing value after calibration  | AFT= 300.0000g    |
|                                   | -COMPLETE         |
| Signature                         | -SIGNATURE-       |

## Minimum Measurement Value (Warning Function) (All models)

Reproducibility can be confirmed by repeatedly measuring weights as instructed by AP series. The minimum sample quantity is automatically determined from the standard deviation and recorded in AP series. If the minimum sample quantity requirement is not satisfied during measurement, an indicator flashes to warn the user.



Minimum sample quantity

## Recipe Function (Achieve Your Preferred Compounding Process)

(W-AD/W Series only)

Sample recipes can be registered, allowing users to simply follow displayed instructions. This is convenient when compounding medicines.

# For Regulation

For Customers at Pharmaceutical Industry—ER/ES Regulatory Compliance—

## LabSolutions Balance

In recent years, data tampering has caused a decline in the reliability of measurement data. To ensure the reliability of measurement data, or in other words data integrity, it is important to retain not only numeric measurement results, but also other measurement information, such as information about who measured the data, when, using which instruments, and under what conditions. Information about the operations involved is also important, including information about transcribing measurement values. Such information about measurements is referred to as metadata, such that measurement results are considered reliable (with data integrity ensured) only if they include corresponding metadata. The same applies to data measured using an analytical balance. LabSolutions Balance is software designed for customers that need to ensure the integrity of analytical balance data in the same manner as for LC and GC data.

## LabSolutions Balance Functionality

- LabSolutions Balance eliminates the need to enter weighing data manually and the risk of transcription errors. All weighing data is saved in a safe database.
- A spreadsheet report of tamper-proof weighing data and analytical data is automatically created.
- Spreadsheet reports can also be customized to customer requirements, such as by combining weighing data with HPLC or other analytical results for system suitability tests, content uniformity tests, or elution tests.

## Using LabSolutions and LabSolutions Balance to Integrate Analytical Data Management via a Network System

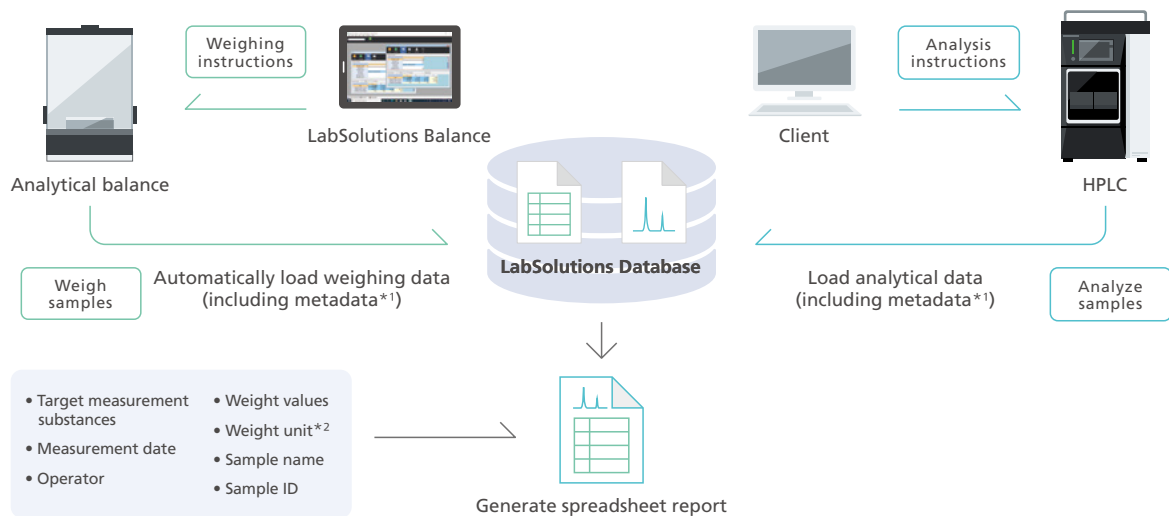

## Integrated Report Creation Function\*3 Combines Analysis Results from HPLC and Weighing Results from a Balance

### Creation of Report Template

It enables creating the report by reading sample data and confirming the sample report at the same time.

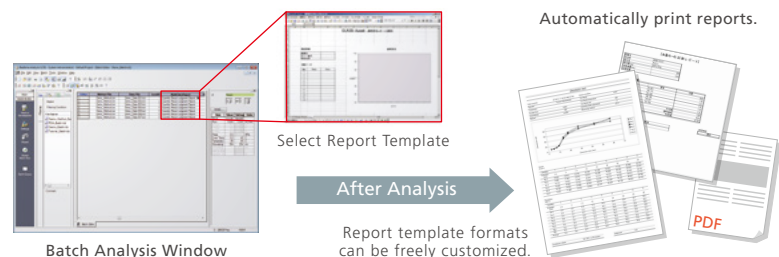

\*1 Metadata refers to information about corresponding data, such as measurement date/time and sample information.

\*2 LabSolutions Balance Ver. 1.0.5 or later

\*3 Multi-data report creation (optional) is necessary to use this function.

## Weighing Process Flow Using LabSolutions Balance

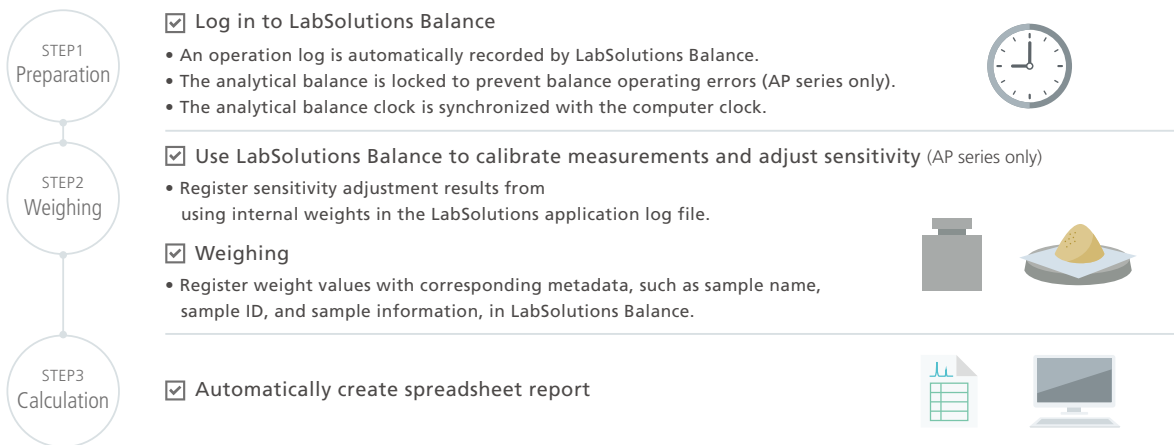

## Compliance with the Latest Data Integrity Requirements and Supplying Templates

- Weighing results are saved in a database together with associated information, such as sample ID, balance operator, weighing date/time, and serial number of the balance used. The sample information can then be used to search results.
- Settings can be configured to only permit users with proper access rights to create templates used for measuring.

## System Operating Status Can be Determined Using the Log Browser

- The system status, such as the system usage status and analytical balance sensitivity calibration records\*4, can be easily viewed using the Log Browser.
- Functionality is included for searching user names, instrument names, or other information in log records, so that necessary information can be checked quickly.
- It also protects data from tampering or unintended overwriting/deleting. Furthermore, analytical balance calibration results\*4 and LabSolutions Balance operation history events are saved together with corresponding reasons in the database as a log record.

## Wireless Networking Capability and Tablet Computer Support Enable Convenient Operation in Confined Spaces

Tablet computer compatibility (with wireless networking\*5) is convenient for weighing rooms or other locations with limited space. Weighing data can be transmitted or saved via the wireless network. Of course, it also supports computers.

### Key Specifications

|                                      |  |
|--------------------------------------|--|
| OS                                   | Windows® 10 Pro / 11 Pro   |
| Compatible Analytical Balance Models | Shimadzu AP, AU, AT-R, AT, UP, UW/UX, and BW-K/BX-K series   |
| Other Functionality                  | Simultaneous connection of up to two analytical balances, PDF file creation, and optional LIMS interface supported |

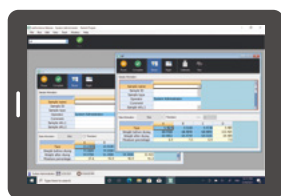

Windows® tablet computer (functionality verified using Surface 7+)



\*4: AP series only

\*5: A wireless router and serial device server are required for using wireless networking functionality.

# Save Your Operation

Equipped with USB as standard. Includes many diverse functions to support users.

## USB Offers Greater Expandability (USB host: W-AD/W Series only)

Equipped with an RS-232C connector, a USB device, and a USB host as standard. You can now simultaneously send output to both a computer and printer or connect a USB flash drive, a barcode reader, or an external numeric keypad. Transcription errors can be avoided and data can be recorded without a computer.



USB and RS-232C are standard



USB host port

## USB flash drive

Connecting a USB memory device allows you to record large amounts of weighing data in CSV format. Used in combination with the interval output function, it also enables recording of long-term changes over time.

\* The information saved will differ depending on the function used.

|                      |                 |
|----------------------|-----------------|
| Examples of a record | File name       |
|                      | Date and time   |
|                      | Weighing values |
|                      | Other           |



## Display capture function

Weighing display can be recorded into USB memory in BMP format. User name, date/time, and setting can be shown with display information. The user name, time, measurement conditions, pass/fail judgments, and other information displayed on screen can be saved as is, enabling the recording of measurements and checks after measurements.



## Numeric keypad

Connecting a common external numeric keypad makes it easier to enter numeric values. This is especially useful for entering the mass value of weights, setting upper/lower limit values for the comparator function, or entering the sample count during piece counting mode.



## Barcode reader

A barcode reader can be connected. Simply reading a barcode makes it possible to input user ID/Password. It is possible to manage sample IDs using barcodes.



An ID and password are needed to log in to the AP series if protected access is activated. With the barcode, an operator can log in by scanning the barcode instead of inputting an ID and password.

Note: Functionality has been verified for OPL-6845S-V-WHT-USB model Optoelectronics barcode readers. However, that model could be discontinued or substituted without notice. The latest information can be seen from the Shimadzu website (<https://www.shimadzu.com/an/balance/>).



## Easy-to-Read Organic EL Display (All models)

### Exceptional Visibility

The visibility remains the same even when viewed from different angles. The viewing angle is a wide expanse of  $\pm 85$  degrees, both vertically and horizontally. That means the display is clearly visible even when working beside the balance. A high-resolution dot-matrix display makes it easy to read detailed text.



Clearly visible from the side

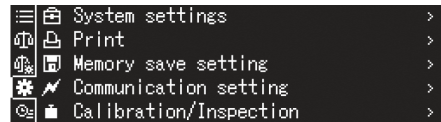

Menu display

Because the pixel elements in the organic electroluminescence display emit light, the screen can be seen clearly even in dark locations. Multi-language display capability\* provides a more intuitive operating interface. A wider viewing angle has also improved the visibility of measurement values, which helps increase the efficiency of measuring operations.

\* Japanese, English, and Chinese

## Periodic Inspection Support Function (W-AD/W/X Series only)

AP series supports periodic inspections. The function allows inspection of repeatability, corner load error, and linearity by simply following instructions displayed on the screen.

### Repeatability Inspection Example

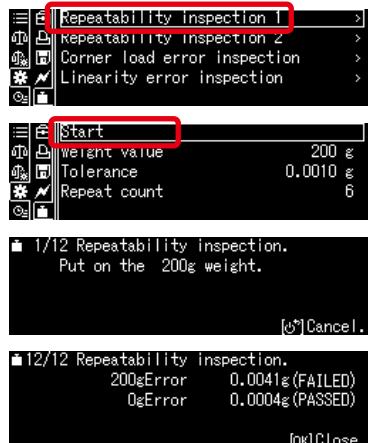

Select the inspection mode.



In this case, repeatability inspection is selected.



Place standard weights as instructed.



Results are displayed.



### Printing sample

| REPEATABILITY |                     |
|---------------|---------------------|
| LOAD          | = 150 g             |
| MPE           | = 0.0010 g          |
| -----         |                     |
| N001          | IL = 150.0000 g     |
|               | I0 = 0.0000 g       |
| N002          | IL = 149.9999 g     |
|               | I0 = -0.0001 g      |
| N003          | IL = 149.9999 g     |
|               | I0 = -0.0001 g      |
| N004          | IL = 149.9999 g     |
|               | I0 = 0.0000 g       |
| N005          | IL = 149.9999 g     |
|               | I0 = 0.0000 g       |
| N006          | IL = 149.9999 g     |
|               | I0 = 0.0000 g       |
| TEST RESULTS  |                     |
| LOAD          | = 0.0001 g (PASSED) |
| ZERO          | = 0.0001 g (PASSED) |

IL: Loaded weight

I0: Zero value

# And more...

Wide Variety of Functions to Support Users

## Smart Setting (All models)

Patented

Response and stability settings can be changed during measurements with a single touch. Changing the settings for different applications can make it even easier to use.

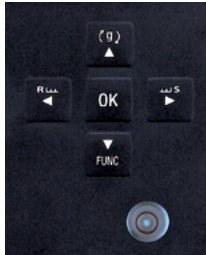

User-friendly arrow keys

The indicator is operated using the left and right arrow keys. Moving the setting toward [R] prioritizes response, which makes it easier to operate the balance. Conversely, moving it toward [S] makes it easier to stabilize weight values, which can improve readability in environments with vibration.

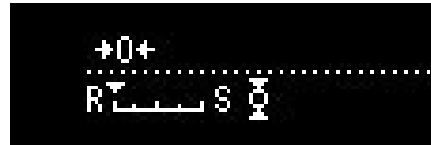

Moving it left prioritizes response and moving it right prioritizes stability. Five setting levels are available.

## Specific Gravity Measurement (All models)

In combination with an optional specific gravity measurement kit, the balance can be used to measure specific gravity. Operations are simplified by a text-based navigation function.

By using sinkers, the specific gravity of liquid can be measured as well. This allows measuring the specific gravity of metals, rubbers, plastics, and other materials easily.



First measure the empty weight.

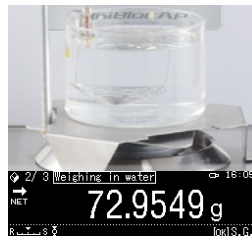

Then place it in the container filled with water, as instructed on the screen.



The specific gravity value is displayed using simple steps.



## For Better Weighing Results (W-AD/WX Series only)

### Two internal weights provided

(models with 0.01 mg minimum display value)

0.01 mg models are calibrated at 2 points with the internal weights (weight value and 1/2 value).

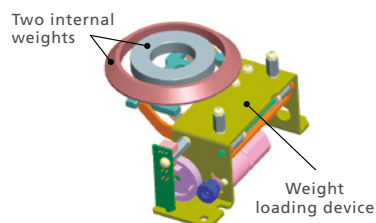

### Includes Perfect Self Calibration (PSC) function

The analytical balance automatically detects any temperature changes that could affect sensitivity and automatically starts calibration.

The Clock-CAL function enables automatic calibration at a pre-specified time (for example, before starting work, during lunch, or after work hours).

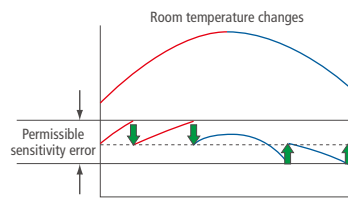

PSC (Perfect Self Calibration)

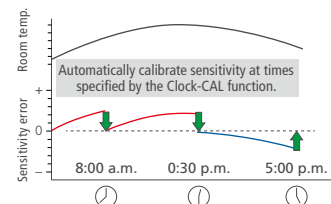

Clock-CAL

## The Reason the AP Holder in Combination with the Ionizer Can Eliminate the Influence of Static Electricity on the Weight Value

If the AP Holder and the STABLO-AP ionizer are used together, static electricity can be quickly removed from the entire test chamber, including the surfaces of glass containers, which helps to decrease the weighing time and improve reliability.

### Example of Removing Static Electricity from a Flask

**Bad** | The conical flask is directly placed on the pan.

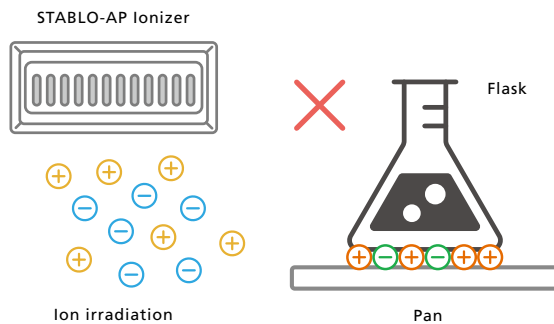

Ions emitted from the ionizer cannot reach the bottom of the flask, so removal of static charge from the bottom of the flask is insufficient. Therefore, Coulomb forces act between the surrounding metal parts and the windshield door, which affects the weight value.

The bottom of the flask is in close contact with the pan, which obstructs removal of the static charge, leading to an unstable weight value.

**Good** | The conical flask is tilted using the AP Holder and placed on the pan.

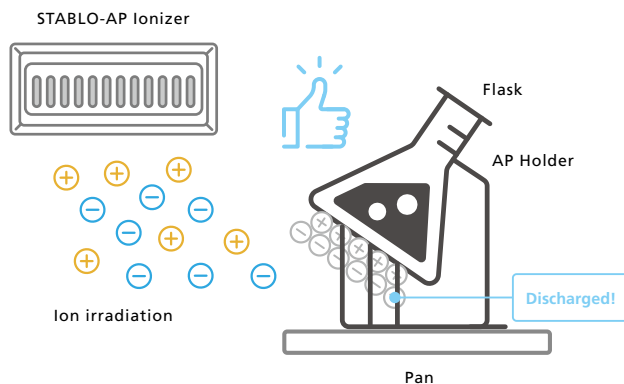

Using the AP Holder to separate the flask from the pan, the ions supplied by the ionizer reach the locations where there is static charge on the bottom of the flask. This improves the neutralization effect and results in a stable weight value.

The AP Holder can hold the container in a tilted position, so the charge can be reliably removed from the bottom of the container being mounted on the AP Holder.

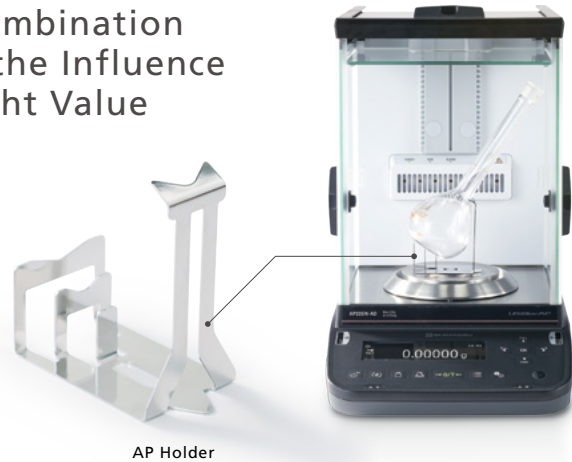

Effect of AP Holder on Eliminating Static Charge (measurement is carried out by Shimadzu)

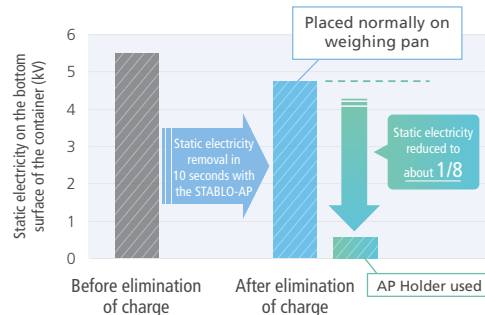

Static electricity on the bottom surface of the charged measuring flask (capacity 100 mL) measured with a surface potentiometer

# AP Series Specifications

## W-AD Series Analytical Balances

(Equipped Standard with Smart Automatic Doors and Touchless Sensors)

| Series  | W-AD Series  |  |                           |                           |                               |                          |  |
|---|--|--|---------------------------|---------------------------|-------------------------------|--------------------------|--|
| Model   | AP225W-AD  | AP135W-AD                                    | AP225WD-AD                | AP125WD-AD                | AP324W-AD                     | AP224W-AD                |  |
| Capacity  | 220 g  | 135 g  | 220 g / 102 g             | 120 g / 52 g              | 320 g                         | 220 g                    |  |
| Minimum Display   | 0.01 mg  |  | 0.1 mg / 0.01 mg          |                           | 0.1 mg                        |                          |  |
| Calibration Weight  | Built-in <sup>(*)</sup>  |  |                           |                           |                               |                          |  |
| External Calibration Weight Range for Span Calibration (recommended weight value) | 95 to 220.00090 g (200 g)  | 45 to 135.00090 g (100 g)                    | 95 to 220.00090 g (200 g) | 45 to 120.00090 g (100 g) | 95 to 320.0090 g (300 g)      | 95 to 220.0090 g (200 g) |  |
| Repeatability (at weighing capacity) <sup>(*)2</sup>                              | 0.015 mg (to 20 g)<br>0.03 mg (to 100 g)<br>0.05 mg (to weighing capacity) | 0.05 mg                                      | 0.1 mg / 0.05 mg          | 0.1 mg / 0.02 mg          | 0.15 mg                       | 0.1 mg                   |  |
| Repeatability (for Low Loads) <sup>(*)2, 3)</sup>                                 | 0.01 mg (for 5 g load)   |  |                           |                           | 0.1 mg (for 20 g load)        | 0.1 mg (for 10 g load)   |  |
| Minimum Weight <sup>(*)2, 3)</sup>  | 20 mg  |  |                           |                           | 200 mg                        |                          |  |
| Linearity <sup>(*)2</sup>   | ±0.1 mg  |  | ±0.2 mg / ±0.1 mg         | ±0.2 mg / ±0.05 mg        | ±0.3 mg                       | ±0.2 mg                  |  |
| Response Time for Trace Measurements <sup>(*)4, 5)</sup>                          | 2 sec.   |  |                           |                           |                               |                          |  |
| Response Time <sup>(*)5)</sup>  | 8 sec.   |  | 2 sec./8 sec.             |                           | 2 sec.                        |                          |  |
| Functions, Options  | USB Host (Type A)  | ○  |                           |                           |                               |                          |  |
|   | USB Device (Type B)  | ○  |                           |                           |                               |                          |  |
|   | Recipe Compounding   | ○  |                           |                           |                               |                          |  |
|   | HPLC Buffer Solution Preparation   | ○  |                           |                           |                               |                          |  |
|   | mol Conversion Function  | ○  |                           |                           |                               |                          |  |
|   | Sample (Concentration) Preparation   | ○  |                           |                           |                               |                          |  |
|   | Inspection Support Function  | ○  |                           |                           |                               |                          |  |
|   | Clock-CAL  | ○  |                           |                           |                               |                          |  |
|   | Automatic Doors  | ○  |                           |                           |                               |                          |  |
|   | Touchless Sensors  | ○  |                           |                           |                               |                          |  |
|   | Adjustable Windbreak Plate   | ○  |                           |                           | —                             |                          |  |
|   | Ionizer <sup>(*)8)</sup>   | ○  |                           |                           |                               |                          |  |
|   | Operational Temperature/Humidity Range                                     | 5 to 40 °C at 20 to 85 % RH <sup>(*)6)</sup> |                           |                           |                               |                          |  |
| Sensitivity Stability Against Temperature Range                                   | ±2 ppm/°C (10 to 30 °C)  |  |                           |                           |                               |                          |  |
| Pan Size  | Approx. 91 mm dia.   |  |                           |                           |                               |                          |  |
| Body Dimensions   | Approx. W215 × D411 × H346 mm (power supply unit included)                 |  |                           |                           | Approx. W215 × D367 × H346 mm |                          |  |
| Weight  | Approx. 9.7 kg   |  |                           |                           | Approx. 8.6 kg                |                          |  |
| Display   | OEL display (dot matrix)   |  |                           |                           |                               |                          |  |
| Rated Electric Power Supply   | DC 12 V 1.5 A  |  |                           |                           |                               |                          |  |
| Power Supply Input (AC Adapter)   | AC100-240 V, 0.48 A 50/60 Hz <sup>(*)7)</sup>                              |  |                           |                           |                               |                          |  |
| Input/Output Terminal   | RS-232C (D-sub 9P plug) USB host (Type A) USB device (Type B) Ionizer      |  |                           |                           |                               |                          |  |

\*1 Minimum display 0.01 mg models provide two internal weights as standard (see page 16 for details).

\*2 Measurement conditions of W-AD series (minimum display 0.01 mg models only) are as follows.  
- Set the adjustable windbreak plate in the lowest position  
- With a shield plate configured around the pan

\*3 Be compliant with USP Chapter 41. This is the tested value by the weight of the balance's capacity of 5 %.  
The minimum weight value is affected by the installation environment, so it is necessary to measure it in the actual environment of use.

\*4 The response time for displaying 90 % of the added sample amount value in trace measurements (from 1 mg).

\*5 The response time value is typical.

\*6 Non-condensing.

\*7 Depending on the attached AC adapter.

\*8 Specifications of the ionizer are shown on the back cover.

## W Series Analytical Balances

| Series  | W Series  |                              |                              |                              |                               |                             |                             |   |
|---|---|------------------------------|------------------------------|------------------------------|-------------------------------|-----------------------------|-----------------------------|---|
| Model   | AP225W  | AP135W                       | AP225WD                      | AP125WD                      | AP324W                        | AP224W                      | AP124W                      |   |
| Capacity  | 220 g   | 135 g                        | 220 g / 102 g                | 120 g / 52 g                 | 320 g                         | 220 g                       | 120 g                       |   |
| Minimum Display   | 0.01 mg   |                              | 0.1 mg / 0.01 mg             |                              | 0.1 mg                        |                             |                             |   |
| Calibration Weight  | Built-in <sup>(*)</sup>   |                              |                              |                              |                               |                             |                             |   |
| External Calibration Weight Range for Span Calibration (recommended weight value) | 95 to 220.00090 g<br>(200 g)  | 45 to 135.00090 g<br>(100 g) | 95 to 220.00090 g<br>(200 g) | 45 to 120.00090 g<br>(100 g) | 95 to 320.0090 g<br>(300 g)   | 95 to 220.0090 g<br>(200 g) | 45 to 120.0090 g<br>(100 g) |   |
| Repeatability (at weighing capacity) <sup>(*)3</sup>                              | 0.015 mg (to 20 g)<br>0.03 mg (to 100 g)<br>0.05 mg<br>(to weighing capacity) | 0.05 mg                      | 0.1 mg / 0.05 mg             | 0.1 mg / 0.02 mg             | 0.15 mg                       | 0.1 mg                      |                             |   |
| Repeatability (for Low Loads) <sup>(*)2,3)</sup>                                  | 0.01 mg (for 5 g load)  |                              |                              |                              | 0.1 mg (for 20 g load)        | 0.1 mg (for 10 g load)      | 0.1 mg (for 5 g load)       |   |
| Minimum Weight <sup>(*)2,3)</sup>   | 20 mg   |                              |                              |                              | 200 mg                        |                             |                             |   |
| Linearity <sup>(*)3)</sup>  | ±0.1 mg   |                              | ±0.2 mg / ±0.1 mg            | ±0.2 mg / ±0.05 mg           | ±0.3 mg                       | ±0.2 mg                     |                             |   |
| Response Time for Trace Measurements <sup>(*)4,5)</sup>                           | 2 sec.  |                              |                              |                              |                               |                             |                             |   |
| Response Time <sup>(*)5)</sup>  | 8 sec.  |                              | 2 sec./8 sec.                |                              | 2 sec.                        |                             |                             |   |
| Functions, Options  | USB Host (Type A)   |                              |                              |                              |                               |                             |                             | ○ |
|   | USB Device (Type B)   |                              |                              |                              |                               |                             |                             | ○ |
|   | Recipe Compounding  |                              |                              |                              |                               |                             |                             | ○ |
|   | HPLC Buffer Solution Preparation  |                              |                              |                              |                               |                             |                             | ○ |
|   | mol Conversion Function   |                              |                              |                              |                               |                             |                             | ○ |
|   | Sample (Concentration) Preparation  |                              |                              |                              |                               |                             |                             | ○ |
|   | Inspection Support Function   |                              |                              |                              |                               |                             |                             | ○ |
|   | Clock-CAL   |                              |                              |                              |                               |                             |                             | ○ |
|   | Internal Windbreak Plate  | ○                            |                              |                              | ○ (Optional)                  |                             |                             |   |
|   | Ionizer <sup>(*)8)</sup>  | ○ (Optional)                 |                              |                              |                               |                             |                             |   |
| Operational Temperature/ Humidity Range   | 5 to 40 °C at 20 to 85 % RH <sup>(*)6)</sup>                                  |                              |                              |                              |                               |                             |                             |   |
| Sensitivity Stability Against Temperature Range                                   | ±2 ppm/°C (10 to 30 °C)   |                              |                              |                              |                               |                             |                             |   |
| Pan Size  | Approx. 91 mm dia.  |                              |                              |                              |                               |                             |                             |   |
| Body Dimensions   | Approx. W213 × D411 × H345 mm (power supply unit included)                    |                              |                              |                              | Approx. W213 × D367 × H345 mm |                             |                             |   |
| Weight  | Approx. 7.9 kg  |                              |                              |                              | Approx. 7.0 kg                |                             |                             |   |
| Display   | OEL display (dot matrix)  |                              |                              |                              |                               |                             |                             |   |
| Rated Electric Power Supply   | DC 12 V 1.0 A   |                              |                              |                              |                               |                             |                             |   |
| Power Supply Input (AC Adapter)   | AC100-240 V, 0.32 A 50/60 Hz <sup>(*)7)</sup>                                 |                              |                              |                              |                               |                             |                             |   |
| Input/Output Terminal   | RS-232C (D-sub 9P plug) USB host (Type A) USB device (Type B) Ionizer         |                              |                              |                              |                               |                             |                             |   |

\*1 Minimum display 0.01 mg models provide two internal weights as standard (see page 16 for details).

\*2 Be compliant with USP Chapter 41. This is the tested value by the weight of the balance's capacity of 5 %. The minimum weight value is affected by the installation environment, so it is necessary to measure it in the actual environment of use.

\*3 The value is the result of a test AP W series (minimum display 0.01 mg models only) with the internal windbreak plate.

\*4 The response time for displaying 90 % of the added sample amount value in trace measurements (from 1 mg).

\*5 The response time value is typical.

\*6 Non-condensing.

\*7 Depending on the attached AC adapter.

\*8 Specifications of the ionizer are shown on the back cover.

# AP Series Specifications

## X Series/Y Series Analytical Balances

| Series  | X Series  |  |                          | Y Series                                    |                          |                          |  |
|---|---|--|--------------------------|---|--------------------------|--------------------------|--|
| Model   | AP324X  | AP224X                                       | AP124X                   | AP324Y                                      | AP224Y                   | AP124Y                   |  |
| Capacity  | 320 g   | 220 g  | 120 g                    | 320 g                                       | 220 g                    | 120 g                    |  |
| Minimum Display   | 0.1 mg  |  |                          |   |                          |                          |  |
| Calibration Weight  | Built-in  |  |                          | None  |                          |                          |  |
| External Calibration Weight Range for Span Calibration (recommended weight value) | 95 to 320.0090 g (300 g)                            | 95 to 220.0090 g (200 g)                     | 45 to 120.0090 g (100 g) | 95 to 320.0090 g (300 g)                    | 95 to 220.0090 g (200 g) | 45 to 120.0090 g (100 g) |  |
| Repeatability (at weighing capacity)  | 0.15 mg   | 0.1 mg                                       |                          | 0.15 mg                                     | 0.1 mg                   |                          |  |
| Repeatability (for Low Loads) <sup>(*)1</sup>                                     | 0.1 mg (for 20 g load)                              | 0.1 mg (for 10 g load)                       | 0.1 mg (for 5 g load)    | 0.1 mg (for 20 g load)                      | 0.1 mg (for 10 g load)   | 0.1 mg (for 5 g load)    |  |
| Minimum Weight <sup>(*)1</sup>  | 200 mg  |  |                          |   |                          |                          |  |
| Linearity   | ±0.3 mg   | ±0.2 mg                                      |                          | ±0.3 mg                                     | ±0.2 mg                  |                          |  |
| Response Time for Trace Measurements <sup>(*)2, 3)</sup>                          | 2 sec.  |  |                          |   |                          |                          |  |
| Response Time <sup>(*)3)</sup>  | 2 sec.  |  |                          |   |                          |                          |  |
| Functions, Options  | USB Host (Type A)                                   | —  |                          |   |                          |                          |  |
|   | USB Device (Type B)                                 | ○  |                          |   |                          |                          |  |
|   | Recipe Compounding                                  | —  |                          |   |                          |                          |  |
|   | HPLC Buffer Solution Preparation                    | —  |                          |   |                          |                          |  |
|   | mol Conversion Function                             | ○  |                          | —   |                          |                          |  |
|   | Sample (Concentration) Preparation                  | —  |                          |   |                          |                          |  |
|   | Inspection Support Function                         | ○  |                          | —   |                          |                          |  |
|   | Clock-CAL   | ○  |                          | —   |                          |                          |  |
|   | Internal Windbreak Plate                            | ○ (Optional)                                 |                          |   |                          |                          |  |
|   | Ionizer <sup>(*)6)</sup>                            | ○ (Optional)                                 |                          |   | —                        |                          |  |
|   | Operational Temperature/Humidity Range              | 5 to 40 °C at 20 to 85 % RH <sup>(*)4)</sup> |                          |   |                          |                          |  |
| Sensitivity Stability Against Temperature Range                                   | ±2 ppm/°C (10 to 30 °C)                             |  |                          |   |                          |                          |  |
| Pan Size  | Approx. 91 mm dia.                                  |  |                          |   |                          |                          |  |
| Body Dimensions   | Approx. W213 × D367 × H345 mm                       |  |                          |   |                          |                          |  |
| Weight  | Approx. 7.0 kg                                      |  |                          | Approx. 6.5 kg                              |                          |                          |  |
| Display   | OEL display (dot matrix)                            |  |                          |   |                          |                          |  |
| Rated Electric Power Supply   | DC 12 V 1.0 A                                       |  |                          |   |                          |                          |  |
| Power Supply Input (AC Adapter)   | AC100-240 V, 0.32 A 50/60 Hz <sup>(*)5)</sup>       |  |                          |   |                          |                          |  |
| Input/Output Terminal   | RS-232C (D-sub 9P plug) USB device (Type B) Ionizer |  |                          | RS-232C (D-sub 9P plug) USB device (Type B) |                          |                          |  |

- \*1 Be compliant with USP Chapter 41. This is the tested value by the weight of the balance's capacity of 5 %. The minimum weight value is affected by the installation environment, so it is necessary to measure it in the actual environment of use.
- \*2 The response time for displaying 90 % of the added sample amount value in trace measurements (from 1 mg)
- \*3 The response time value is typical.
- \*4 Non-condensing.
- \*5 Depending on the attached AC adapter.
- \*6 Specifications of the ionizer are shown on the back cover.



## AP Series



\* Power supply unit included.

Minimum display  
0.01 mg Model

- AP225W-AD
- AP135W-AD

Minimum display  
0.01 mg/0.1 mg Model

- AP225WD-AD
- AP125WD-AD



Minimum display  
0.1 mg Model

- AP324W-AD
- AP224W-AD



\* Power supply unit included.

Minimum display  
0.01 mg Model

- AP225W
- AP135W

Minimum display  
0.01 mg/0.1 mg Model

- AP225WD
- AP125WD



Minimum display  
0.1 mg Model

- AP324W
- AP224W
- AP124W
- AP324X
- AP224X
- AP124X
- AP324Y
- AP224Y
- AP124Y

# Dimensions

## External Dimensions of AP W-AD Series (Unit: mm)

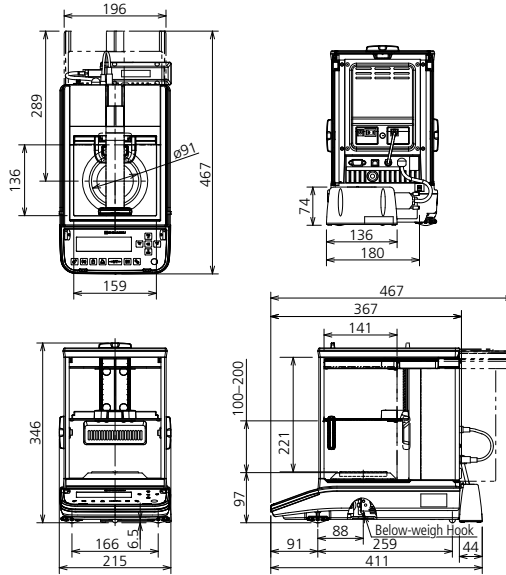

Minimum display 0.01 mg Model  
Weight: Approx. 9.7 kg

- AP225W-AD    ▪ AP225WD-AD
- AP135W-AD    ▪ AP125WD-AD

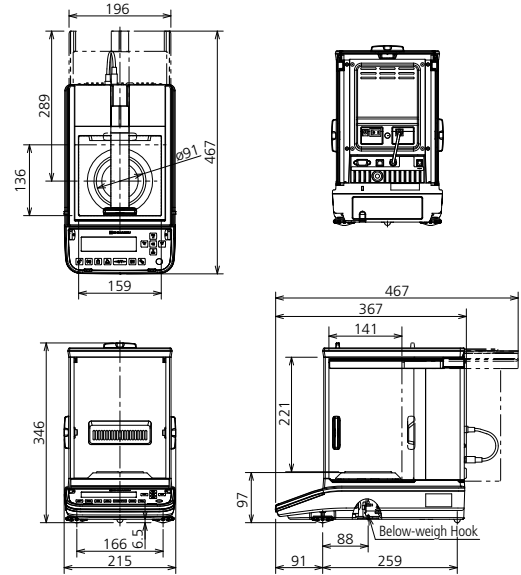

Minimum display 0.1 mg Model  
Weight: Approx. 8.6 kg

- AP324W-AD
- AP224W-AD

## AP W/X/Y Series Dimensions (Unit: mm)

(The blue portion is exclusive to the AP-W series or AP-X series.)

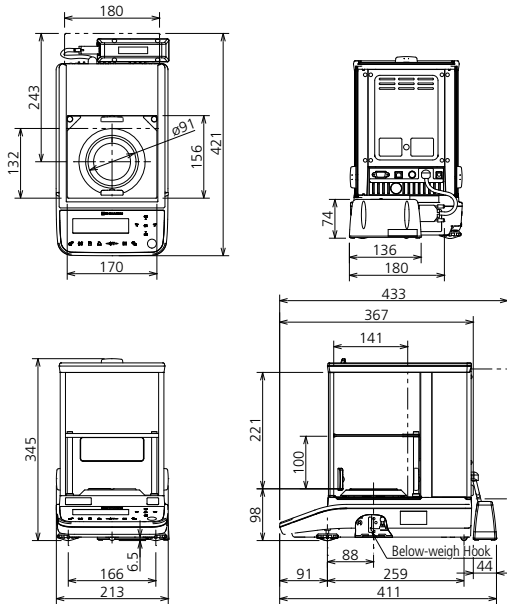

Minimum display 0.01 mg Model  
Weight: Approx. 9.7 kg

- AP225W    ▪ AP225WD
- AP135W    ▪ AP125WD

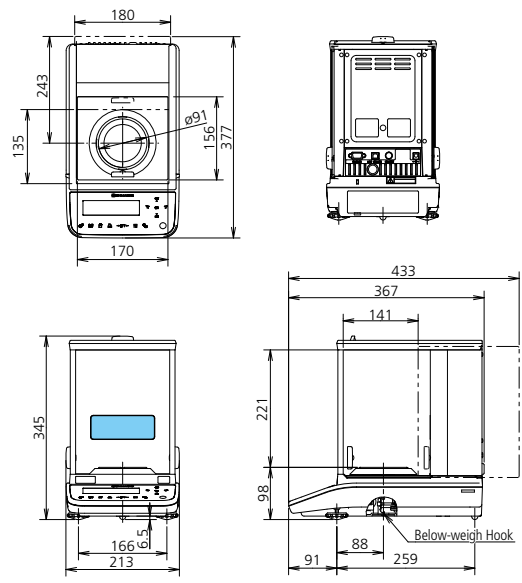

Minimum display 0.1 mg Model  
Weight: Approx. 7.0 kg

- AP324W    ▪ AP324X
- AP224W    ▪ AP224X
- AP124W    ▪ AP124X

Weight: Approx. 6.5 kg

- AP324Y
- AP224Y
- AP124Y

Dimensions (unit: mm) and weight are approximate. Appearance and specifications are subject to change without prior notice.

# Options

## Multi-Stand (included standard with W-AD Series 0.01 mg models only)

If placing weighing paper, microtubes, or other containers that exceed the pan diameter, or when weighing long rod-like samples, attach a specialized multi-stand to easily weigh samples.

< Example Using a Multi-Stand >



Weighing Paper



Microtubes



Rod-Like Samples



AP (0.01 mg models)

## Internal Windbreak Plate (included standard with W Series 0.01 mg models only)

The plate suppresses the influence of convection and airflow within the weighing chamber to improve the stability and response of measurement values.



Internal Windbreak Plate  
(for W/X/Y series models)

## Static Electricity Remover (Ionizer)

**STABLOAP**

Freely reconfigurable between external stand configuration or installed inside the balance unit.

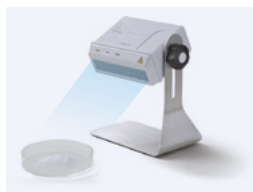

When using a stand



Built-in

## Other Optional Products



SMK-601 Specific Gravity Measurement Kit



EP-100 Printer



EP-110 Printer  
(multi-functional printer with LCD display)



AP Holder

## STABLO-AP Ionizer Dimensions (Unit: mm) / Specifications

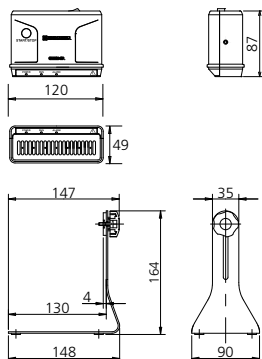

|                                    |  |
|------------------------------------|--|
| Ion Generation Method              | AC corona discharge  |
| Ion Balance *1                     | ±10 V  |
| Effective Static Removal Range     | Distance (from Emitter Port): To about 400 mm              |
| Static Elimination Time *2         | 1 sec.   |
| Ozone Concentration                | 0.06 ppm max. (at center of 150 mm area from emitter port) |
| Electrode Probes (material)        | Tungsten (durability: 30,000 hours)                        |
| Operating Temperature and Humidity | 0 °C to +40 °C, 25 % RH to 85 % RH (non-condensing)        |
| Rated Electric Power Supply        | DC 24 V 1.0 A  |
| Power Supply Input (AC Adapter)    | AC 100 V 0.58 A 50/60 Hz                                   |
| Weight                             | Approx. 710 g (Main unit: 395 g, Stand: 315 g)             |
| Body Dimensions                    | Approx. 120*3 × 87 × 49 mm                                 |

\*1: Typical values when measured with a 20 pF 150 mm × 150 mm charged plate monitor (CPM), at 100 mm from the center of the nozzle (at the time of shipment)

\*2: Elimination time from a static charge of ±1000 V down to ±100 V, at 100 mm from the center of the nozzle (at the time of shipment)

\*3: Excluding protruding parts

## List of Optional Products

| Description  |
|--|
| STABLO-AP Ionizer (Static Electricity Remover)   |
| EP-100 Printer   |
| EP-110 Printer (Multifunction Printer with Organic Liquid Crystal Display)                           |
| Label Roll Paper for EP-100/110 (10 Rolls)   |
| Internal Windbreak Plate (Included standard with Minimum Display 0.01 mg W Series, for W/X/Y Series) |
| SMK-601 Specific Gravity Measurement Kit   |
| AP Holder (Included standard with AP225W-AD/AP225W models)   |
| Multi Stand (Included standard with Minimum Display 0.01 mg W-AD Series)                             |
| AC Adapter (for W/X/Y Series)  |
| AC Adapter (for W-AD Series Balances)  |
| AC Adapter (for W-AD Series STABLO-AP Ionizers)  |
| Display Protective Cover (Set of 5)  |
| USB Cable Assembly (2 m) with Core   |
| RS-IO Adapter Cable (for Connecting EP-80/90)  |

UniBloc, LabSolutions and STABLO are registered trademarks of Shimadzu Corporation or its affiliated companies in Japan and other countries. Windows and Surface Go are either registered trademarks or trademarks of Microsoft Corporation in the United States and/or other countries.



Shimadzu Corporation  
[www.shimadzu.com/an/](http://www.shimadzu.com/an/)

### For Research Use Only. Not for use in diagnostic procedures.

This publication may contain references to products that are not available in your country. Please contact us to check the availability of these products in your country.

Company names, products/service names and logos used in this publication are trademarks and trade names of Shimadzu Corporation, its subsidiaries or its affiliates, whether or not they are used with trademark symbol "TM" or "®".

Third-party trademarks and trade names may be used in this publication to refer to either the entities or their products/services, whether or not they are used with trademark symbol "TM" or "®".

Shimadzu disclaims any proprietary interest in trademarks and trade names other than its own.

The contents of this publication are provided to you "as is" without warranty of any kind, and are subject to change without notice. Shimadzu does not assume any responsibility or liability for any damage, whether direct or indirect, relating to the use of this publication.