

Excel in productivity

Extended quantitative performance made accessible

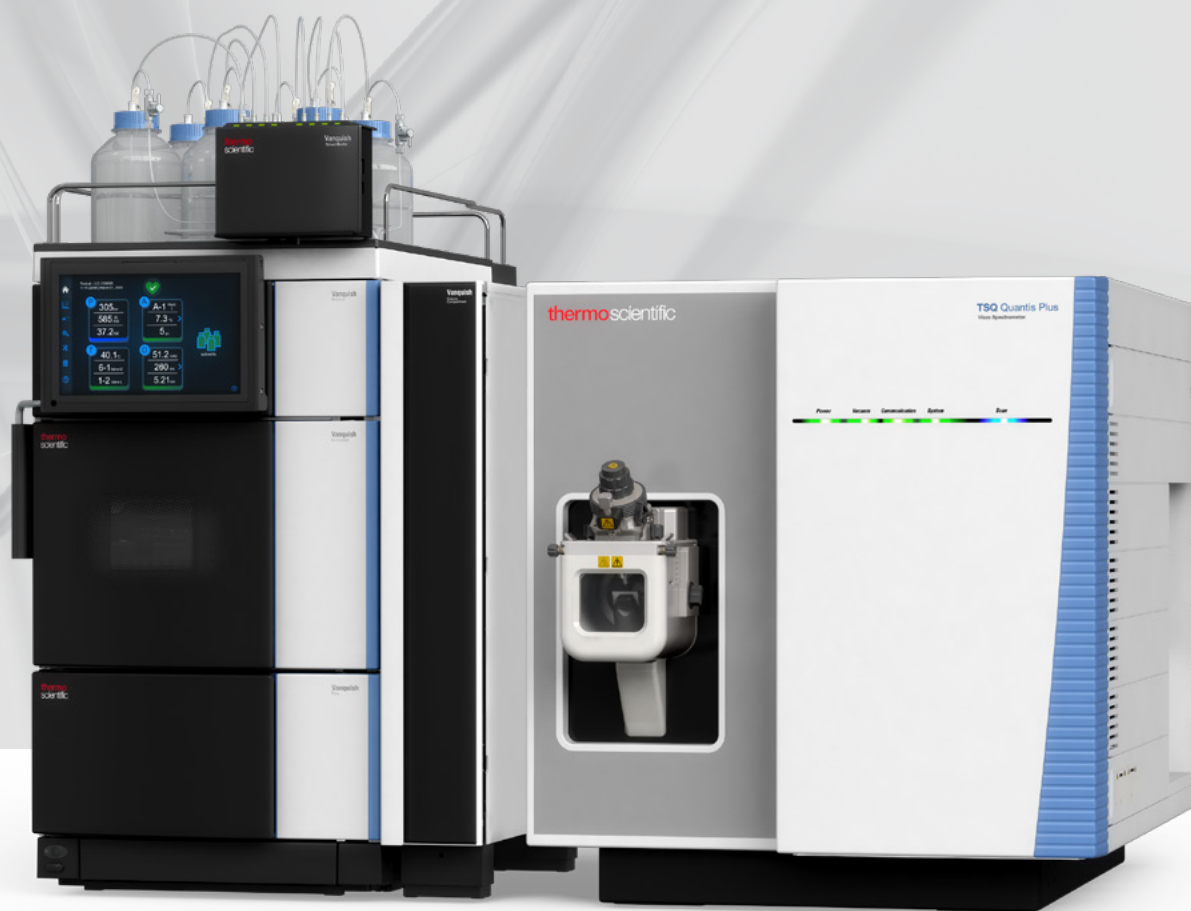

TSQ Quantis Plus triple quadrupole mass spectrometer

Advance your quantitative capabilities: TSQ Quantis Plus MS with **AIM+** Technology

Active Reaction Collision Cell II (ARC II) with axial DC fields
Enables ultra-fast selected reaction monitoring (SRM).

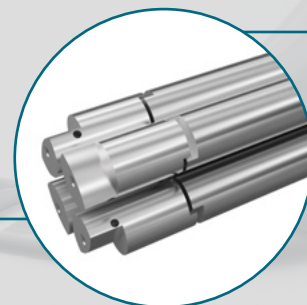
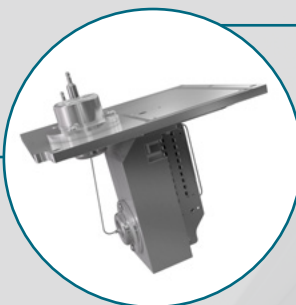
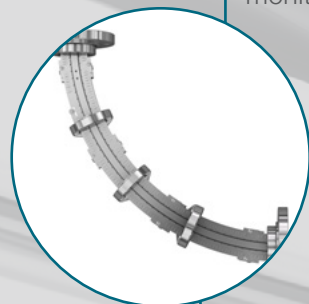

Ion transfer tube and sweep cone
Provide maximum robustness and tool-free maintenance.

Stacked ring ion guide (RF lens)
Efficient ion introduction minimizing fragmentation and maximizing sensitivity.

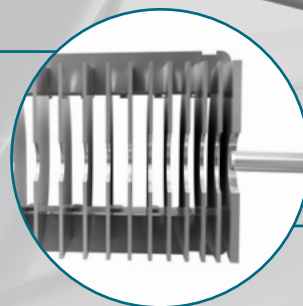

Quantitative throughput with confidence

Laboratory demands continue to increase with new requirements for more compounds at lower levels. You need a solution you can trust to deliver effective and efficient workflows, day after day. The Thermo Scientific™ TSQ Quantis™ Plus mass spectrometer delivers robust and reliable quantitation with the sensitivity and selectivity required to meet your workflow needs. Designed with ease-of-use in mind to ensure maximum productivity for every user in every laboratory.

Sensitive, selective, fast

Innovations to the ion source, quadrupole mass filters, collision cell, and RF electronics provide the sensitivity, speed, reliability, and consistency to confidently quantify compounds, day after day.

Robust, reliable, reproducible

The TSQ Quantis Plus mass spectrometer is designed for stable, reliable performance, and incorporates innovative approaches to increase robustness and reduce maintenance requirements. Every TSQ Quantis Plus mass spectrometer will produce data that you can have confidence in.

Active Ion Management Plus (AIM+) Technology

The next step in precision design delivers the ultimate in ion management, inception to detection, from the Thermo Scientific™ OptaMax™ NG ion source housing to the enhanced electron multiplier. AIM+ Technology incorporates segmented quadrupoles and enhanced RF electronics to further optimize ion management precision, reliability, speed, and reproducibility.

Designed to ensure confidence in your results

To achieve your business and scientific goals, you need results you can count on. Regardless of your application, the TSQ Quantis Plus triple quadrupole mass spectrometer enables targeted quantitation workflows that ensure high-quality results and confidence through innovative designs that provide exceptional reliability, consistency, robustness, and the sensitivity you need to meet your workflow needs.

Enhanced dual-mode discrete-dynode electron multiplier detector

Extends multiplier lifetime with increased surface area. Maintains excellent linearity and dynamic range.

QR4 segmented quadrupole mass filter with hyperbolic surfaces

Enhances ion transmission and consistency to ensure excellent sensitivity and reproducible results across instruments and over time for increased productivity.

Ion beam guide with neutral blocker

Provides robust performance and maximum sensitivity by blocking neutrals and efficiently transmitting ions.

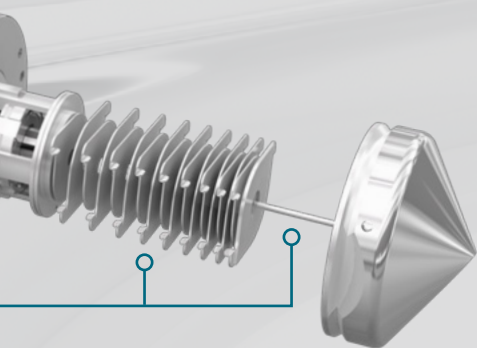

OptaMax NG ion source APCI-ready

Automates all gas and voltage connections for ease-of-use. Provides optimizable spray position for ultimate performance in HESI or APCI mode.

Everyday usability to maximize productivity

The TSQ Quantis Plus mass spectrometer provides practical ease-of-use and performance features to increase productivity.

- Simple maintenance and an intuitive calibration routine
- Integration of Thermo Scientific™ mzCloud™ database enables confident method building or expansion
- Automated compound optimization with dwell time prioritization
- Selected Reaction Monitoring (SRM) visualization and optimization
- Streamlined data review and reporting

Automated Compound Optimization— User-defined list of compounds optimized automatically

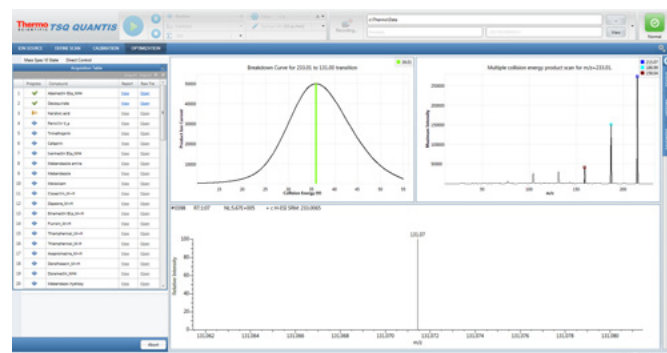

Keep up with regulatory limits in Environmental and Food Safety testing

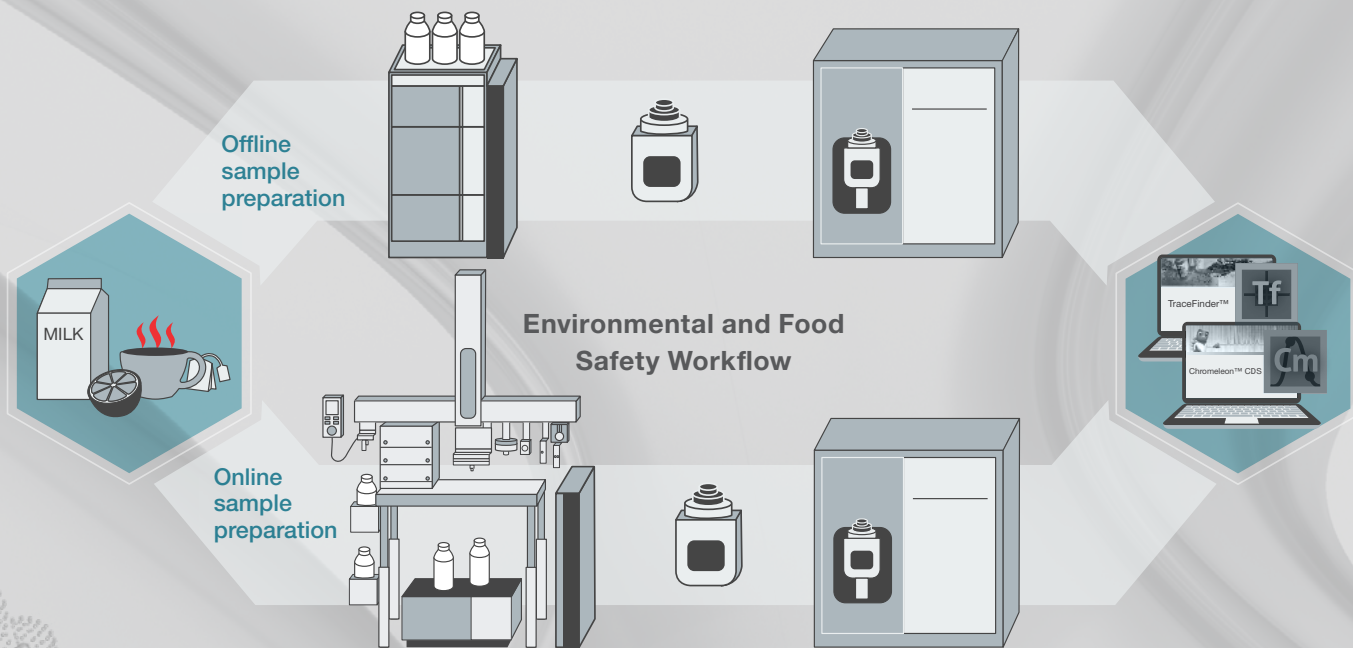

The TSQ Quantis Plus mass spectrometer enables environmental and food safety testing labs to address regulatory requirements with ease.

- **Increased confidence**—Improved low-mass product ion transmission

- **Streamlined workflows**—Automated compound optimization and application-specific methods and reports
- **Superior acquisition speed**—Fast polarity switching and SRM acquisition speeds enable complex methods coupled to UHPLC and HPIC separations

Monitoring multiple compounds per unit time with excellent quantitation performance at low dwell times

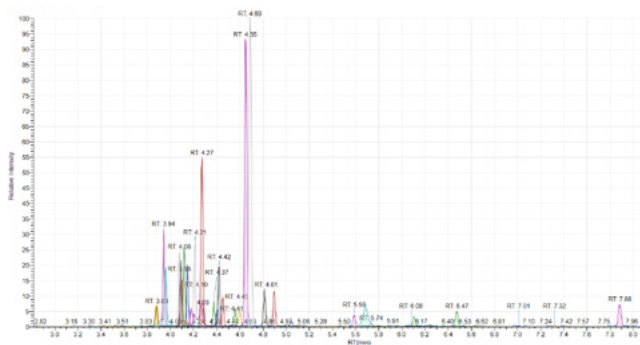

Equal molar mix (2 ppb) of veterinary drugs spiked into pork tissue.

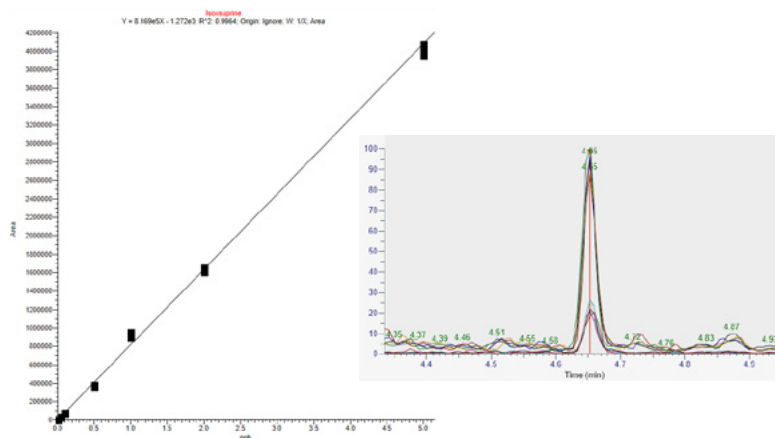

Quantitation curve for Isoxsuprine spiked into pork tissue with the inset showing overlaid SRM response of the quantifying and qualifying SRM transitions for 5 injections at a spiked level of 50 ppt.

Overcome your **Pharma** and **Biopharmaceutical** challenges

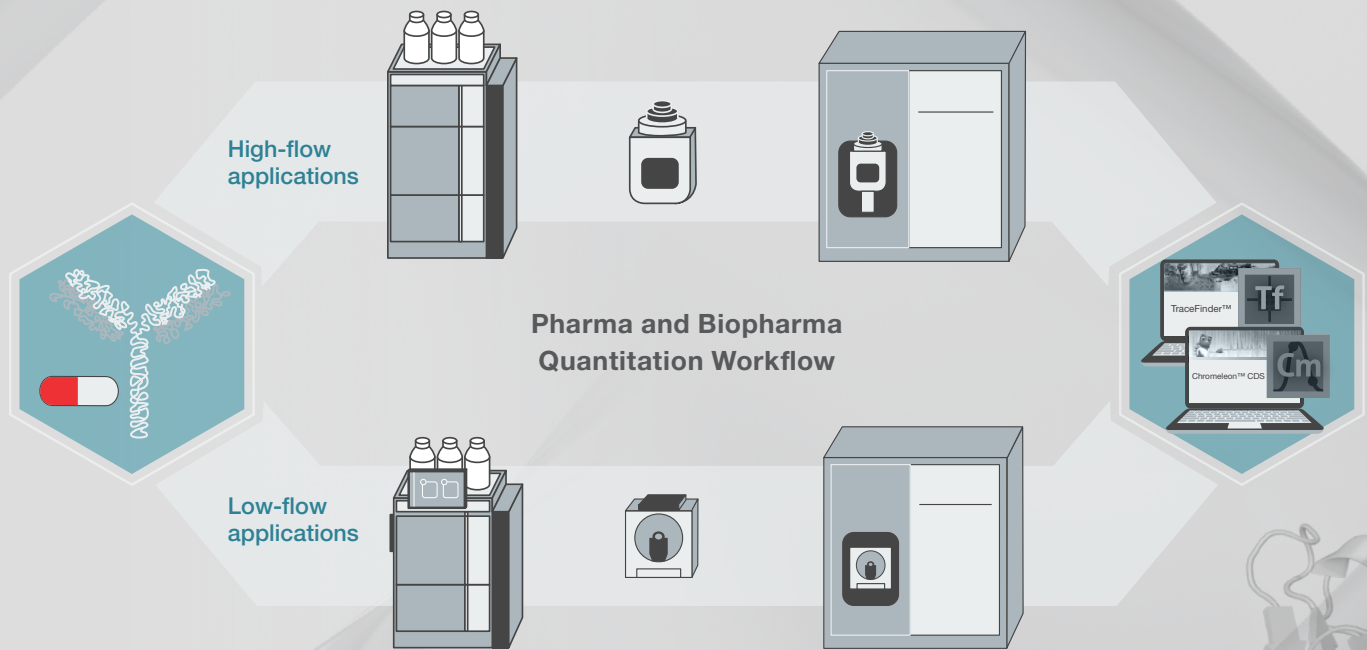

The usability, robustness, and reliability of the TSQ Quantis Plus mass spectrometer enable around-the-clock operation and maximize productivity in pharma and biopharmaceutical labs.

- **Increased data confidence**—Enhanced collision cell performance improves critical low-mass qualifying product ion detection

- **Ease-of-use**—Intuitive instrument software ensures quality data, regardless of user expertise
- **Overcome matrix interference**—Enhanced selectivity with High-Resolution Selected Reaction Monitoring (H-SRM) and optional Thermo Scientific™ FAIMS Pro Duo interface increases specificity
- **Powerful workflow solutions**—Incorporation of industry-leading UHPLC separations and data processing software

Consistent ion ratios for confident peptide quantitation

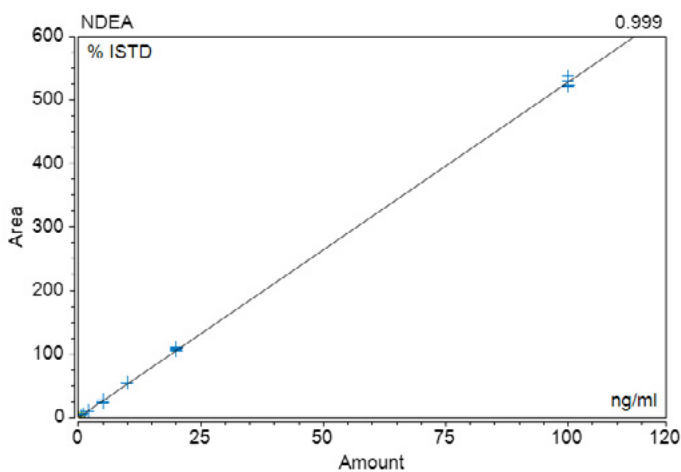

Quantitative response for NDEA in Metformin from 0.2 to 100 ppm.

Excellent linearity and reproducibility across the dynamic range

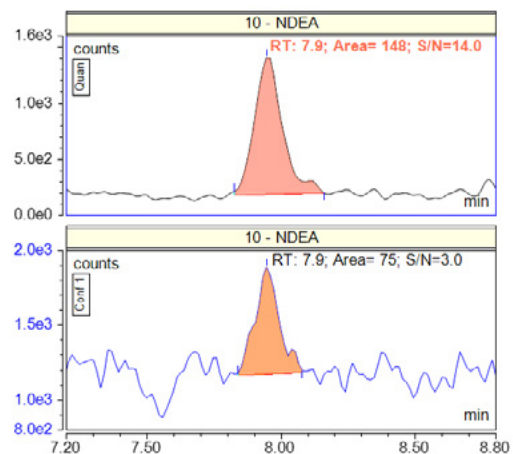

Quantitative and qualitative SRM transition analysis for NDEA in Metformin at 5 ppb.

Obtain more confidence in **Clinical Research** and **Forensic Toxicology** results



The TSQ Quantis Plus mass spectrometer's reliability and sensitivity allow you to report results with confidence. Effortless method set up with industry-leading multi-channel solutions and automated reporting enables robust, high-throughput quantitation.

- Robust and consistent, able to run thousands of samples with simple maintenance that takes minutes to perform with no loss of performance
- Intuitive software empowers users to easily create and modify experimental methods
- Sensitivity and reproducibility make challenging assays easy

Excellent quantitative precision and accuracy in the most challenging matrices

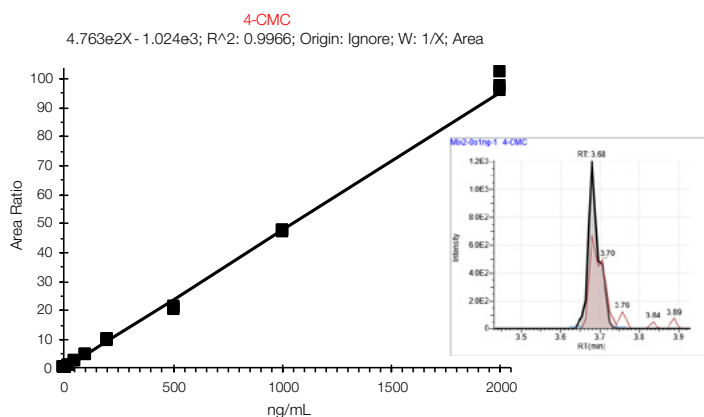

Quantitation curve for 4-CMC spiked into whole blood prior to protein crash and direct analysis. The inset shows the quantitative response for 4-CMC at 0.01 ng/mL.

Robust and consistent performance under challenging conditions

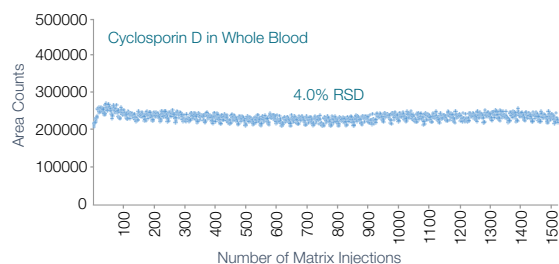

More than 1,500 injections with consistent performance.

Companion solutions for the TSQ Quantis Plus mass spectrometer

Workflow-driven software, solutions, and support streamline your applications

Integrated workflow-driven software and solutions streamline everyday tasks from instrument optimization and troubleshooting to routine method development and results reporting.



Thermo Scientific™ TraceFinder™ software

Comprehensive quantitative workflows for all applications— from method development to report generation



AppsLab method library

A comprehensive repository for application methods, data sets, and application notes



Thermo Scientific™ Chromeleon™ software

Offers enterprise instrument control, data processing, and ability to address regulatory requirements



Thermo Scientific™ mzCloud™ mass spectral library

The world's largest LC-MS¹ reference spectral library for an expansive and chemically diverse compound collection

Our global Centers of Excellence, in-your-lab training using your methods, and AppsLab library of analytical applications, ensure your success.

Chromatography solutions for MS

The TSQ Quantis Plus mass spectrometer can be paired with a range of high-performance Thermo Scientific™ inlet systems.

- Thermo Scientific™ Vanquish™ Neo, Core, Flex, Horizon, and Duo UHPLC systems
- Thermo Scientific™ Transcend™ II system with Multi-channel and TurboFlow™ technology
- Thermo Scientific™ Transcend™ LX-1, LX-2, and LX-4 UHPLC systems
- Thermo Scientific™ Transcend™ TLX-2 and TLX-4 UHPLC systems
- Thermo Scientific™ Dionex™ ICS-6000 Capillary HPLC™ system
- Thermo Scientific™ Dionex™ Integrion™ HPLC™ system
- Thermo Scientific™ TriPlus™ RSH EQuan 850 system



Transforming triple quadrupole mass spectrometers

The TSQ Quantis Plus mass spectrometer is one in a family of latest-generation Thermo Scientific™ triple quadrupole mass spectrometers that offers advanced productivity every day, for every lab and every user.

These instruments are built on a foundation of shared, state-of-the-art hardware and software components. This makes it easier to transfer methods from one instrument to another when methods progress from single, sample-based experiments to validation and routine, high-volume targeted screening and quantitation.



Almanac web-based monitoring and management

Stay connected to your science. See how the Thermo Scientific™ Almanac™ application can help you get the most out of your instruments.

thermofisher.com/almanac



Technical and online support: peak performance for your instruments

Helping you keep your instruments running at peak performance is our goal. Whether you're looking for an instrument manual or spare parts, want to submit a repair request, or check on the status of your warranty or service contract, we have every support option you're looking for.

thermofisher.com/technicalresources



Protecting your investments: unparalleled laboratory services

Unity™ Lab Services provides a single source for integrated lab service, support, and supply management. Our customized service offerings and world-class service experts have the flexibility and experience to address your laboratory's needs. We provide a complete portfolio of services and support solutions designed to help you improve productivity, reduce total cost of ownership, and ensure performance throughout your laboratory.

unitylabservices.com

Find out more at thermofisher.com/QuantisPlus

ThermoFisher
SCIENTIFIC