



Chromatography, Mass Spectrometry,
and Lab Informatics Product Reference Guide

World-class solutions

Transform your science

Leading analytical technologies • Applications expertise • Global support

Thermo
SCIENTIFIC

Thermo Scientific brand products bring leading capabilities in ion chromatography (IC), liquid chromatography (LC), gas chromatography (GC), mass spectrometry (MS), sample preparation, inductively-coupled plasma mass spectrometry (ICP-MS), discrete analyzers (DA), and software to the industry's leading portfolio, creating new possibilities for scientific analyses and providing solutions to challenging analytical problems in diverse areas, including critical applications in environmental protection and those in life sciences.

The following pages illustrate the range, scope, and excellence of our combined offerings, where you'll find the best of separation science meeting the leading mass spectrometry solutions to help move your science forward.

table of contents

• Sample Prep	4-5
• UHPLC for all LC Systems	6-7
• UHPLC Accessories and Supplies	8-9
• HPLC and UHPLC	10-11
• GC and GC-MS	12-13
• Columns and Consumables	14-15
• Ion Chromatography (IC)	16-17
• Discrete Analysis (DA)	18-19
• IC and RFIC Accessories	20-21
• Chromatography, MS and LIMS Software	22-23
• LC-MS	24-25
• Orbitrap LC-MS	26-27
• Software MS	28-29
• Trace Elemental Analysis	30-31
• Inorganic MS	32-33
• Omics	34-35
• Pharma and Biopharma	36-37
• Food and Beverage Safety	38-39
• Environmental Analysis	40-41
• Clinical and Forensic Toxicology	42-43
• Service and Support	44-45

Leading
Instruments



Optimized
accessories



Informative
software

new discoveries.

Liquid Chromatography

Leading LC, UHPLC, and nano-LC systems



Gas Chromatography

Our portfolio of GC, GC-MS, and GC-MS/MS solutions

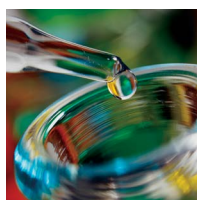

Ion Chromatography

Standard, reagent-free IC and capillary IC systems from the world-wide leader

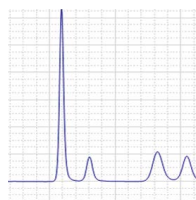

Mass Spectrometry

Systems for precise identification and quantification

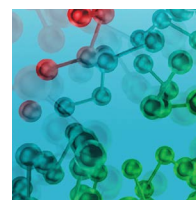

Chromatography, MS and LIMS Software

Faster data interpretation and information flow

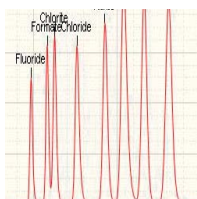

Sample Preparation

Better extractions in less time



ICP-MS

Outstanding productivity and greater confidence

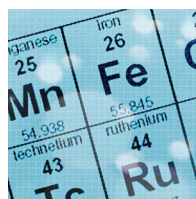

DA

Automated Photometry DA systems for fast and effective testing and quality monitoring



Knowledgeable
method
development



Timely
service



Unsurpassed
commitment

Solvent extractions that normally require labor-intensive steps are automated and performed in minutes, with reduced solvent consumption and reduced sample handling using Thermo Scientific™ Dionex™ ASE™ 350 Accelerated Solvent Extraction and Thermo Scientific™ Dionex™ AutoTrace™ 280 Solid-Phase Extraction systems. The Dionex ASE 350 system is dramatically



Dionex ASE 350 System

The Dionex ASE 350 system is a proprietary technique for the extraction of analytes from solid and semi-solid sample matrices using common solvents at elevated temperatures and pressures. Compared to techniques such as Soxhlet and sonication, the Dionex ASE system generates results in a fraction of the time.

Benefits:

- Extractions for sample sizes 1–100 g in minutes
- Dramatic reduction in solvent usage
- Wide range of applications
- Corrosion-resistance components
- Approved for use by the U.S. EPA and CLP Program
- Walk away automation for unattended operation
- Hood-free operation



Dionex AutoTrace 280 SPE Instrument

The Dionex AutoTrace 280 SPE instrument performs automated solid-phase extractions (SPE) of large-volume liquid samples for organic analysis. Liquid – liquid extractions that normally take hours can be automated using a Dionex AutoTrace 280 SPE instrument.

Benefits:

- Automated extractions for liquid sample sizes of 20 mL–4 L
- Dramatic reduction in solvent usage and reduced sample handling
- Wide range of applications
- Approved for use by many government agencies
- Compatible with disk or cartridge configurations
- Extraction of six channels simultaneously

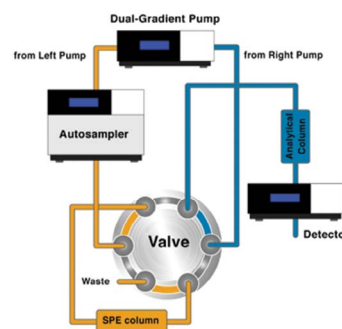

Automated On-line SPE-LC

A solution kit for the Thermo Scientific™ Dionex™ UltiMate™ 3000 x2 Dual HPLC systems provides fully automated on-line solid-phase extraction (SPE) for high-sensitivity analysis from even complex matrices. Samples are injected directly onto an SPE column, the matrix is removed, and the enriched analyte transferred to an analytical column.

Benefits:

- Direct injection of untreated samples
- Fast analysis and high reproducibility
- Full automation for unattended operation
- Reduction of health risks
- Highest productivity

more efficient Sample Prep Systems

faster than Soxhlet, sonication, and other extraction methods, and requires significantly less solvent and labor. Accelerated solvent extraction methods are accepted and established in the environmental, pharmaceutical, food, polymer, and consumer product industries. Accelerated solvent extraction methods are accepted and used by government agencies worldwide.



Rocket Evaporator System

The Thermo Scientific™ Rocket™ Evaporator System is a revolutionary solvent evaporator for use in laboratories seeking to spend minimal time and effort to process multiple samples for analysis. It can dry or concentrate up to six 450 mL flasks, or 18 ASE vials. This enables the user to focus on other tasks, confident that the Rocket Evaporator system will achieve perfect, reproducible results every time.

Benefits:

- Vacuum and centrifugal evaporation for controlled evaporation and minimized sample loss
- ASE and AutoTrace compatible vessels reducing solvent handling
- End point detection
- Superior solvent recovery



IC Sample Preparation Solutions

Products include solutions for IC sample preparation with AutoPrep and Reagent-Free Ion Chromatography – Electrolytic Sample Preparation (RFIC-ESP).

AutoPrep automatically prepares calibration curves and performs sample analyses. Unique plumbing configurations and automated valve operations simplifies trace level analysis.

RFIC-ESP systems enable a range of automated sample preparation techniques using proprietary electrolytic devices to reduce cost and provide higher value analyses.

RFIC-ESP devices and techniques can remove cations from an anion sample before analysis using a Thermo Scientific Dionex CR-TC Continuously Regenerated Trap Column, or neutralizing a strongly acidic or basic solution.



Sample Preparation Accessories

The Thermo Scientific™ Dionex™ InGuard™ inline and Thermo Scientific™ Dionex™ OnGuard™ II offline cartridges remove matrix interferences such as phenolics, metals, cations, anions, or hydrophobic substances encountered in many ion chromatography applications.

Dionex OnGuard II Cartridges:

Remove matrix interferences such as phenolics, metals, cations, anions, or hydrophobic substances, for better performance in many IC applications.

Dionex InGuard Cartridges:

This line of sample pretreatment cartridges removes matrix interferences such as cations (including transition metals), anions, or hydrophobic substances encountered in many IC applications.

Thermo Scientific™ Dionex™ SolEx™

Solid Phase Extraction Cartridges:

Offers a variety of chemistries and sizes to fit your needs.

UHPLC delivers important benefits – faster runs, better resolution, and lower operating costs. The Thermo Scientific liquid chromatography platform is the most complete LC solution provided by a single chromatography powerhouse.

UHPLC⁺ focused

By enabling all of our Thermo Scientific™ Dionex™ UltiMate™ 3000 systems to be UHPLC compatible by design, we provide the market-leading system solutions to all users, all laboratories and all analytes. We also provide the latest in state-of-the-art UHPLC with the Thermo Scientific™ Vanquish™ UHPLC system, delivering better separations, more results, and easier interaction than ever before.

Our advanced workflow automation and software solutions boost the productivity and ease-of-use of your liquid chromatography systems beyond traditional concepts:

- Dual gradient pump technology for your LC workflow automation with unmatched productivity
- Exceptional flow-pressure footprint for all our pumps for maximum column diameter flexibility
- Unique detectors and flow cells
- Seamless and advanced integration with mass spectrometry
- Highly productive chromatography data system and mass spectrometry software
- Thermo Scientific AppsLab Library of analytical applications, a powerful online library for chromatography methods and eWorkflows™



Vanquish UHPLC System

The Vanquish UHPLC system takes high-end UHPLC to a new level. The system addresses the needs of chromatographers performing state-of-the-art UHPLC, within a single integrated, fully biocompatible and flexible platform, all while meeting the throughput demands of modern laboratories.

The Vanquish system offers:

- Better Separations—Separate more peaks than ever before. Vanquish UHPLC applies the most advanced technologies for all of your critical separations
- More Results—Regain time during your projects. Vanquish UHPLC improves analysis speed, increases sample capacity, and has improved robustness
- Easier Interaction—Vanquish UHPLC has an optimized design and automation features and works with the operational simplicity of the gold standard Thermo Scientific™ Dionex™ Chromeleon™ Chromatography Data System software



Vanquish Flex System

The Vanquish Flex UHPLC system expands the capabilities of the Vanquish platform by adding state-of-the-art quaternary solvent blending and versatile detection options, along with advanced speed, resolution and sensitivity, allowing users to perform biocompatible analysis for high quality and consistent data.

The Vanquish Flex system offers:

- Up to 1034 bar of pump pressure and flow rates up to 8 mL/min
- 4 solvent channels for quaternary solvent mixing
- Intelligent SmartInject technology for excellent injections up to 100 µL in 0.01 µL increments
- Versatile detection options including DAD, CAD and FLD

more versatile UHPLC for all LC Systems



UltiMate 3000 Rapid Separation LC Systems

The UltiMate 3000 Rapid Separation LC (RSLC) systems integrate unique hardware features for ultrafast separations and excellent resolution using columns with small particles. In addition, they are characterized by a maximum level of reliability and flexibility.

- Binary or quaternary systems for both UHPLC and conventional HPLC applications
- Extensive flow-pressure-footprint for ultrafast, ultrahigh-resolution separations
- Column pressures up to 1000 bar
- x2 Dual RSLC systems for ultimate productivity solutions
- Bio RSLC option also available for a completely biocompatible workflows



UltiMate 3000 Standard LC Systems

The UltiMate 3000 Standard LC systems provide the right solution for demanding, analytical, and semipreparative LC applications.

- Optimal performance and reliability for conventional LC applications
- 620 bar maximum pressure and 100 Hz detectors for UHPLC compatibility
- Widest range of system configurations for maximum application flexibility
- Flow rates up to 10 mL/min covering all application needs
- Biocompatible version available (up to 350 bar)



UltiMate 3000 Basic LC Systems

The UltiMate 3000 Basic systems are cost-effective solutions for conventional HPLC and UHPLC. Fully-scaleable, modular basic systems are designed to provide consistent, robust operation and are even compatible with UHPLC applications.

- Cost effective system for routine applications
- 620 bar maximum pressure and 100 Hz data rate for UHPLC compatibility
- Optional Autosampler Column Compartment with integrated sampling and temperature control

Thermo Scientific LC modules integrate innovation and intelligent features into a broad selection of autosampler, injector, pump, flow-control, thermostatted column compartment, and detector modules. We offer a wide variety of LC and Bio columns for any analytical application, as well as accessories for use with our HPLC systems.



UltiMate 3000 Pumps

The UltiMate 3000 pump family offers the most complete choice in the industry. From nano LC to rapid separation applications, from conventional applications to UHPLC, the UltiMate 3000 pumps always provide industry-leading flow, pressure, and precision.

Isocratic: Analytical

Binary: RSLCnano, Analytical, RSLC

Quaternary: Micro, Analytical, RSLC

Dual-Gradient: Micro, Analytical, RSLC



Samplers and Column Compartments

The UltiMate 3000 autosamplers ensure reliable, precise, and accurate injections of nL to mL sample volumes, with extremely low carry-overs. Fraction collection options range from simple collection to advanced collection-reinjection workflows such as automated offline 2D-LC.

Autosamplers: Split-Loop, Pulled-Loop with integrated column compartment

Fraction Collectors: Fraction Collector, Autosampler/Fraction Collector, MALDI Spotter

Column Compartments: Integrated Switching Valves

Detectors, Accessories and Supplies

more comprehensive UHPLC



Detectors

Optical Detectors: Thermo Scientific optical detectors are available for UV-vis absorbance, fluorescence, and refractive-index detection of a wide variety of analytes.

Charged Aerosol Detectors: Thermo Scientific charged aerosol detectors provide universal detection of any non-volatile analyte and many semivolatile compounds, with or without chromophores. Detectors are available for both the Vanquish UHPLC system and the UltiMate 3000 platform.

Electrochemical Detectors: Thermo Scientific Dionex UltiMate 3000 ECD-3000RS Electrochemical Detector offers easy, direct measurement to femtogram levels in very limited sample volumes with minimal preparation. It readily eliminates matrix interferences to enhance selectivity. Users have a choice of both coulometric and amperometric sensors for extremely selective analyses using microbore to normal bore columns for both HPLC and UHPLC. This is the only electrochemical detector compatible with gradient chromatography.



MSQ Plus Mass Spectrometer

The Thermo Scientific™ MSQ™ Plus mass spectrometer can be used in a wide range of applications and methodologies in both HPLC and IC. Only 12 inches wide, the MSQ Plus MS is a compact mass spectrometer providing universal detection and characterization of analytes in the 17–2000 m/z range. Compatible with existing LC and IC methods, the MSQ Plus MS is sensitive, rugged, powerful, easy to use and integrates seamlessly with LC and IC systems.

The leader in LC-MS innovation provides additional liquid chromatography solutions for a range of dedicated analytical needs. Whatever your requirements, Thermo Scientific LC, UHPLC, nano-LC, and LC-MS systems deliver the performance your laboratory demands.



Transcend II System with Multiplexing and TurboFlow Technology

The Thermo Scientific™ Transcend™ II system, now equipped with high-performance UltiMate 3000 RSLC pumps, combines Thermo Scientific™ TurboFlow™ technology for online sample cleanup of complex matrices with automated 2X or 4X multiplexing for unparalleled sample throughput in an LC system.



Prelude SPLC System

Practical, cost-effective LC-MS analysis is now ready for clinical research and forensic toxicology labs. The Thermo Scientific™ Prelude SPLC™ Sample Preparation and Liquid Chromatography system enables fast, reproducible, and reliable online sample preparation with high-performance chromatographic separation.

more dedicated nano LC systems



UltiMate 3000 RSLCnano Systems

The UltiMate 3000 RSLCnano systems optimize low flow separations and facilitate easy coupling to mass spectrometry to provide the best resolution, sensitivity, and selectivity for nano LC and proteomics applications.

- Ideal for analysis with limited sample amounts
- High sensitivity to allow detection of femtomoles or even lower
- Maximum robustness and repeatability for consistent results
- Increased resolution and selectivity for more reliable identification
- Widest nano/cap/micro flow range from 20 nL/min up to 50 μ L/min



EASY-nLC 1000

Speed up your existing proteomics and other nano UHPLC workflows while improving separations for your analyses. The Thermo Scientific™ EASY-nLC™ 1000 delivers sharper peaks for better resolution and increased protein coverage with accurate and precise solvent flow management. Dual flow sensors placed ahead of the mixer ensure precise gradients for reproducible results. nanoViper technology and a large touch screen make the system easy to set up and use. The result is more, higher quality data in less time with a lot less effort.

Environmental, food safety, toxicology, and forensic gas chromatography applications are more demanding than ever. Our portfolio of GC, GC-MS, and GC-MS/MS is geared to meet the challenge.



TRACE 1300 Series GC Gas Chromatographs

Developed around key innovations driven by customer needs, including user-installable instant connect injectors and detectors, unique and patented solutions to conserve helium carrier gas while running analyses, and optimized and miniaturized electronic components, the compact Thermo Scientific™ TRACE™ 1300 Series GC is extremely fast, easy to use, and delivers high lab productivity at a much reduced cost of ownership. The new high-capacity TRACE 1310 auxiliary oven has multi-valve, multi-column capacity and enables the use of up to four conventional detectors simultaneously.



ISQ Single Quadrupole GC-MS

The Thermo Scientific™ ISQ™ GC-MS system offers rugged and reliable performance and nonstop productivity. The ISQ GC-MS features a new source design ideal for continuous high-throughput operation. The vacuum interlock enables source removal without venting the system, for nonstop productivity.



TSQ Duo GC-MS/MS

The Thermo Scientific™ TSQ™ Duo GC-MS/MS system is like no other. It is tailored to chromatographers and single quadrupole GC-MS users who need easy access to powerful new workflows through MS/MS while satisfying their current methods requirements. The system accomplishes this by providing excellent performance, in both single quadrupole and triple quadrupole modes. Whether you are new to GC-MS/MS or not, all you need is your current compound list and/or method and the intuitive software will create, optimize, and manage your single and triple quadrupole methods. The TSQ Duo GC-MS/MS is the only cost-sensitive instrument that enables truly simple, single and triple stage mass spectrometry in a single investment.

more productive GC and GC-MS Systems



TSQ 8000 Evo GC-MS/MS

For labs looking for the next step up in triple quadrupole GC-MS/MS productivity, the Thermo Scientific™ TSQ™ 8000 Evo triple quadrupole mass spectrometer provides more capacity, more information, more compounds, and more results per unit of time for higher levels of productivity and efficiency in analytical workflows. Unlike other GC triple quadrupole mass spectrometers that require extensive, time consuming method setup, the TSQ 8000 Evo GC-MS/MS has a purpose-built software, AutoSRM, for automated SRM method creation, optimization and management from full scan to the complete analytical method setup. It's fast, simple, and reliable.



TSQ 8000 Evo Pesticide Analyzer

The TSQ 8000 Evo Pesticide Analyzer brings a compelling productivity opportunity to your laboratory. This tailored solution composed of hardware, software, consumables, methods, and additional tools allows for more efficient lab workflows, which accelerate sample turnaround times and minimize cost per sample. This performance is achieved through increased selectivity and sensitivity, leading to highly efficient, consolidated methods with rapid data processing and universal “just enough” sample preparation upstream of the system.



Q Exactive GC Orbitrap GC-MS/MS

The Thermo Scientific™ Q Exactive™ GC system represents the first-ever combination of high-resolution gas chromatography and high-resolution, accurate-mass (HRAM) Orbitrap mass spectrometry. This easy-to-use system provides the most comprehensive characterization of samples in a single analysis for the highest confidence in compound discovery, identification, and quantitation. Building upon the flexible modularity of the TRACE 1300 Series GC, including user-exchangeable injectors and detectors, the Q Exactive GC system has the quantitative power of a GC triple quadrupole MS combined with the high precision, full scan high-resolution, accurate-mass capability that only Orbitrap technology can offer.



DFS Magnetic Sector GC-HRMS

The Thermo Scientific™ DFS™ magnetic sector GC-HRMS is the gold standard in dioxin and POPs analysis. It offers worldwide full compliance with any official dioxin, PCB, or PBDE method (EPA 1613, 1668, 1614, etc.). The DFS is the highest performing mass spectrometer ever built for target compound analysis. Its large-volume ion source offers the highest available dioxin sensitivity at maximum robustness, resulting in the best dioxin installation spec on the market: 20 fg 2378-TCDD gives a signal-to-noise ratio $\geq 200:1$ (PtP, 4s). A product based on 50 years of experience in developing magnetic sector MS, the DFS system has all the performance you need in a package that will even fit in a small laboratory.

Discover the most comprehensive array of chromatography solutions available, from sample preparation to sample handling to GC and LC columns. Our innovative products help deliver workflow efficiencies, improved sample security, and innovative column chemistry solutions that meet the world's changing requirements.



Thermo Scientific Sample Preparation Solutions

A range of products using innovative technologies for your analytical needs.

SOLa μ ™ Plates: Offering cleaner, highly reproducible, and robust sample extraction at very low sample volumes.

SOLA™ Cartridges and Plates: Maximizing reproducibility while delivering clean and consistent extractions.

QuEChERS-Dispersive SPE: Efficient pesticide sample preparation from food matrices.



Thermo Scientific Sample Handling Solutions

Ensure sample integrity with a comprehensive range of solutions to meet all application demands.

- Virtuoso™ Vial Identification System
- SureStop™ Vials and Advanced Vial Closure System (AVCS)
- Certified Vial Kits
- Micro Sampling Options
- Headspace Vials
- High Recovery Vials
- Tools and Accessories



Thermo Scientific BioLC Columns

Nano Columns: A wide range of dedicated Acclaim™ PepMap™ nano columns with zero-dead-volume connections and EASY-Spray™ integrated column emitter devices.

Rapid Separation LC Columns: Acclaim RSLC columns for ultimate speed and resolution in UHPLC.

Mixed-Mode Columns: Includes unique chemistries with tunable selectivities for charged and non-charged analytes.

Bio Columns: A wide range of polymeric chemistries and a unique monolith technology for the separation of biomolecules.

more versatile Columns and Consumables

GC, HPLC and SPE

www.thermoscientific.com/crc

Visit the Chromatography Resource Center, an extensive and fully searchable library of chromatography columns and consumables applications.



Thermo Scientific LC Columns and Accessories

Columns for Fast LC

Accucore™ HPLC/UHPLC Columns:

- Solid core particle design
- Fast separations with excellent resolution
- Low backpressures
- Increased assay ruggedness

Hypersil GOLD™ LC Columns:

- Excellent peak shape
- Increased sensitivity
- Improved resolution
- 1.9 to 12 µm particles

Hypercarb™ LC Columns: 100% porous graphitic carbon provides extended separation, exceptional retention of very polar analytes.

- pH stable from 0 to 14
- Ideal for high temperature

Viper™ Fitting System:

- The Viper and nanoViper fitting systems eliminate problems experienced with conventional fitting systems
- Zero-dead-volume UHPLC fingertight fittings for nano/cap, micro, and analytical LC
- Compatible with virtually every type of valve and column hardware
- Flexible stainless steel or fused silica capillaries



Thermo Scientific GC Columns and Accessories

Redefine your expectations for GC with our line of GC Columns

TraceGOLD™ GC Columns provide a leap forward in column performance by delivering low bleed and superior inertness.

TracePLOT™ GC Columns offer the latest innovation in PLOT column technology, providing reproducible analyses of permanent gases, hydrocarbons and solvents.

A range of proven consumables for optimum system performance. Including septa, liners, ferrules and syringes.



Thermo Scientific GC Derivatization Reagents and Standards

Derivatization reagents for mass spectrometry, high-pressure liquid chromatography, and gas chromatography.

Reagents designed to provide selectivity and improve sensitivity.

- Derivatization and Visualization Reagents for HPLC
- GC Derivatization Reagents
- HPLC and Spectrophotometric Grade Solvents
- HPLC Ion Pair Reagents
- Other HPLC Reagents
- Siliconizing Fluids



Thermo Scientific Dionex IC technology has evolved over many product generations, each providing enhanced performance, greater reliability, and easier operation. Reagent-Free™ IC (RFIC™) systems eliminate daily tasks of eluent and regenerant preparation, saving time, preventing errors, and increasing convenience.



**Reagent-Free
Ion Chromatography Systems
Deliver Superior Results**

RFIC-EG systems use electrolytic technologies to generate eluent on demand from deionized water, and to suppress the eluent back to pure water. They deliver unmatched sensitivity and the separating power of gradient IC, all with “just add water” convenience.

Capillary IC takes convenience to new level. Using only 5 L of eluent per year, and needing no service or calibration for months at a time, a Thermo Scientific Dionex ICS-5000+ capillary IC system is always ready to run samples. It’s the world’s first IC that enables true walk-up analysis on demand.

RFIC-ER systems use electrolytic technologies to suppress the eluent prior to detection, and to continuously regenerate eluent from the column effluent. With RFIC-ER, you can run routine applications for a month on a single batch of eluent.



**Dionex ICS-5000+ Modular
RFIC-EG System**

The world’s most advanced IC system provides unmatched capability, flexibility, and convenience. Available in single or dual configurations in analytical scale and/or capillary formats, and with a broad selection of detectors, the Dionex ICS-5000+ IC system provides optimum performance for any IC application.

Key Features:

- Modular design adapts to diverse and changing analytical needs
- RFIC-EG, plus quaternary gradient proportioning and vacuum degasser, provides ultimate eluent flexibility
- Extremely precise temperature control dramatically reduces noise and drift



**Thermo Scientific Dionex
ICS-2100 RFIC-EG System**

This compact integrated Thermo Scientific Dionex IC system makes its own eluent from deionized water. Just add water and get excellent results for a wide range of conductivity-based methods using isocratic or gradient elution.

Key Features:

- Compact design conserves bench space while providing easy access to fluidics
- Touchscreen LCD display allows convenient front-panel control
- Integrated eluent generator produces precise gradients on demand – just add water!
- Column heater reduces noise and drift

more confidence Ion Chromatography Systems



Thermo Scientific Dionex ICS-1600, Thermo Scientific Dionex ICS-1100 RFIC-ER Systems

Compact, integrated Thermo Scientific Dionex IC systems provides good performance for common conductivity-based IC methods.

Key Features:

- Compact design conserves bench space while providing easy access to fluidics
- Touchscreen LCD display allows convenient front-panel control (Dionex ICS-1600 system)
- RFIC-ER option allows continuous operation for up to a month using a single bottle of eluent
- Column heater reduces noise and drift (Dionex ICS-1600 system)
- Electrolytic suppression effortlessly improves signal/noise ratio
- Support for standard-bore and microbore formats offers flexibility
- Optional vacuum degasser saves labor and prevents cavitation (Dionex ICS-1600 system)



Thermo Scientific Dionex ICS-900 Basic IC System

This compact, entry-level unit delivers good performance for basic Thermo Scientific Dionex IC applications using manually prepared eluents.

Key Features:

- Compact design conserves bench space while providing easy access to fluidics
- Displacement Chemical Regeneration suppression provides low noise and stable baselines
- Support for standard-bore and microbore formats offers flexibility
- Optional external column heater reduces noise and drift

Thermo Scientific™ Gallery™ series analyzers are easy-to-use automated photometric systems that allow laboratories to simplify their testing and to increase efficiency. The discrete cell technology offers faster, reproducible results with less sample and reagent waste, providing a



Gallery

The Gallery™ analyzer provides excellence and efficiency in a benchtop system. Discrete analyzers use colorimetric, enzymatic and electrochemical measurements specifically designed for food, beverage and environmental quality control and testing. Several tests can be run simultaneously offering reproducible results of up to 200 tests per hour.

Gallery Plus

The Gallery™ Plus analyzer can accommodate up to 54 samples and 42 reagents in its separated sample and reagent carousels and has the capability to run up to 350 tests per hour. First results are typically ready in as little as ten minutes. There is no reagent priming required, no risk of carry over, nor a need for an external water source.

more productivity Discrete Analyzers

quick, economical solution. With the technology, low detection levels can be achieved. This self-contained system has been successfully adapted to more than 50 food and beverage and environmental applications and can simultaneously measure multiple analytes.



Gallery Plus Beermaster

The Gallery™ Plus Beermaster is specifically designed to improve productivity in a beer production facility and is dedicated to beer, wort, and malt analysis and quality control. Labor intensive bitterness testing has been automated saving time spent in sample pretreatment and analysis. Other analytes, such as beta-glucan, pH, and sulfur dioxide can be simultaneously measured from the same sample.



System Reagents

Thermo Scientific System Reagents provide a complete solution. They are ready to use, optimized kits that save hands-on time, reduce errors, and minimize reagent waste. Bar-coded reagent bottles include volume, lot, and expiration dates providing real-time reagent monitoring. A wide range of calibration standards are available with full traceability. Standard solutions are certified and lot controlled.

Staying the leader in IC for over 35 years requires more than having the best instruments. Thermo Scientific Dionex products encompass not only instruments, but also industry-leading automation, software, and chemistries – all of which work together to provide you with



Autosamplers

A selection of Thermo Scientific Dionex IC autosamplers, all with metal-free flow paths, supports diverse application and budgetary requirements.

Thermo Scientific Dionex AS-AP

Autosampler: This high-performance autosampler provides increased sample capacity, fast injection times, maximum precision, and broad application flexibility. Inject from vials and/or wellplate positions in any desired order, automate sample preparation, and deliver samples to one or two instruments.

Thermo Scientific Dionex

AS-DV Autosampler: This economical autosampler automatically filters samples as it delivers them. It supports 5 mL and/or 0.5 mL vials, and can load sample onto an injection loop or concentrator column.

Thermo Scientific Dionex AS-HV

Autosampler: This versatile autosampler supports a wide range of sample containers, and is ideal for applications involving trace-level contaminants in high-purity water.



Eluent Generation Cartridges (EGC)

The Thermo Scientific Dionex EGC Eluent Generation Cartridge generates high-purity hydroxide, carbonate, or methanesulfonic acid (MSA) eluents electrolytically. Stop spending time manually preparing eluents. With Dionex EGC cartridges, you just add water.

Key Features:

- Simplified operation; no need to prepare eluents or regenerants
- Improves analytical reproducibility, day-to-day, week-to-week, month-to-month
- Ensures system-to-system reproducibility and lab-to-lab consistency
- Achieves sensitive results with pure, uncontaminated eluent
- Eliminates errors and variability associated with manual eluent and regenerant preparation



Electrolytically Regenerated Suppressor (ERS)

Suppression works two ways to achieve the absolute best sensitivity and corresponding lowest detection limits for inorganic analyses; it increases analyte signal while simultaneously decreasing background signal and noise. The Thermo Scientific™ Dionex™ ERS™ 500 Electrolytically Regenerated Suppressor supports virtually all analytical scale ion chromatography applications for both anions and cations.

Key Features:

- Low background noise levels
- Fast startup equilibration times
- Trace anion and cation determinations
- Compatibility with mass spectrometry detection
- Compatibility with all Thermo Scientific Dionex ICS chromatography modules
- A three-fold increase in backpressure tolerance compared to previous generations
- Compatible with 4 μm columns

more applications IC and RFIC Accessories

comprehensive solutions to your analytical challenges. When you need an analytical solution for inorganic ions, organic acids, amines, sugars, proteins, peptides, or other challenging species, find out what we can do for you.



Continuously Regenerated Trap Column (CR-TC)

Designed for eluent generators in RFIC systems, the Dionex CR-TC Continuously Regenerated Trap Columns remove all anionic or ationic contaminants in the eluent continuously and provide very low baseline drift during gradient operations.

Key Features:

- Generates contaminant-free deionized source water and eluent
- Time savings—no need to perform regeneration off-line
- Very low baseline drift for improved integration and increased sensitivity
- Increased productivity; quality data soon after startup
- Removal of carbonic acid contaminants from source water
- Compatibility with capillary RFIC-EG systems



Carbonate Removal Device (CRD)

The Thermo Scientific Dionex CRD Carbonate Removal Device removes carbon dioxide from the suppressed eluent stream by diffusion through the walls of a gas permeable membrane. With carbonate eluent systems, it reduces background signals to nearly the same levels as those of hydroxide eluents.

- Optimized for the removal of carbonate from hydroxide eluent systems:
- Improves quantitation by minimizing carbonate
- Lowers backgrounds, providing higher sensitivity
- Eliminates carbonic acid, increasing the linear range



Thermo Scientific™ Dionex™ IonPac™ Columns

At the heart of Dionex ion chromatography is a unique set of column chemistries that provide high selectivities and efficiencies with excellent peak shapes.

Hydroxide-Selective Anion-

Exchange Columns: For isocratic and gradient separations with a wide range of capacities and selectivities.

Carbonate Eluent Anion-

Exchange Columns: Provides well-characterized isocratic separations for regulated drinking water and wastewater methods.

Cation-Exchange Columns:

Available in a wide range of capacities and hydrophobicities for isocratic and gradient applications.

Ion-Exclusion Columns: Allows separation of weak acids-with strong acids eluting in the void.

Our enabling software solutions include enterprise-level offerings for global deployment, as well as software designed to maximize the functionality and efficiencies of our world-class scientific instruments.



**CHROMELEON
Chromatography Data System**

Every laboratory is different and faces unique challenges. We want those challenges to be your science, not your data handling system. Therefore, we developed Chromeleon 7 CDS.

- One chromatography data system (CDS) for all chromatography laboratories – routine, development, or research – regulated or not.
- One CDS for third party GC and HPLC instruments and all of Thermo Scientific GC, HPLC, IC, and recent GC-MS and LC-MS instruments.
- One CDS for standalone instruments, networked laboratories and multi-site enterprise deployment while keeping the same user experience.

Customers report time savings of multiple hours per sequence and significantly reduced cost-of-operation after implementing Chromeleon 7 CDS.

Integrates seamlessly into existing IT infrastructures, with easy deployment for browser-based operation using Citrix or Microsoft® Terminal Server or in a virtual environment.

thermoscientific.com/chromeleon



AppsLab Library

Thermo Scientific™ AppsLab Library of Analytical Applications is a chromatographer’s web-portal to our comprehensive application expertise. This open, free-of-charge repository with over 1,000 methods available today is being constantly updated with new applications.

Chromatographers can download complete applications enabling them to recreate the method on their existing hardware and chromatography data system. Having information on methods and consumables accessible in one central repository can save significant method development time.

Customers who are using our gold standard Chromeleon CDS software can download one-click workflows, including processing methods and report templates, from AppsLab Library directly into Chromeleon CDS, ready to run.

thermoscientific.com/AppsLab

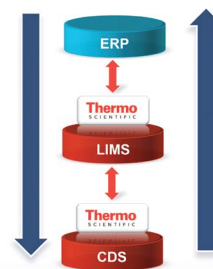

**Integrated CDS and Informatics
Offering**

The combination of Thermo Scientific Chromeleon CDS with Thermo Scientific Informatics solutions turns your laboratory data into actionable knowledge and provides sophisticated data process, visualization, search, and data mining tools.

Chromeleon CDS offers a digital, bi-directional out-of-the-box interface with the industry-leading Thermo Scientific SampleManager LIMS™ for a single vendor data handling and data management solution. The combination of SampleManager LIMS and Chromeleon CDS delivers a seamless integration supported by one company with integrated workflows that drive the lab process all the way from sample reception through to reporting.

Chromeleon CDS also allows you to use Thermo Scientific Data Integration Software for secure, long-term raw data archiving and scientific data management.

Chromatography and LIMS

more connected Software

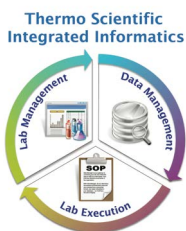

Thermo Scientific Lab Information Management Systems

Thermo Scientific™ SampleManager LIMS™: Laboratories worldwide seeking a single, integrated informatics platform can now standardize on one comprehensive laboratory information management system (LIMS).

SampleManager LIMS now encompasses LIMS, LES, and SDMS functionality so that laboratories no longer need to purchase, implement, validate, and support software packages from multiple vendors. The significant cost savings can instead be invested back into the business to drive new innovation.

Integrated Informatics, encompassing laboratory information management (LIMS), scientific data management (SDMS), and lab execution (LES), enables labs to execute and manage all their laboratory processes easily, with the data rigor and intelligence that laboratory management requires to drive efficiency and profitability for the lab and the business.

The tightly integrated informatics platform of SampleManager LIMS now features more intuitive dashboards and an enhanced Statistical Quality Control (SQC) capability designed to detect nonconformance trending before it reaches predefined thresholds. For pharmaceutical QA/QC labs, enhanced SampleManager LIMS stability improves study management, substudy execution, and planning and maintenance of study inventory.



Thermo Scientific™ Watson LIMS™

For clinical and pre-clinical drug development laboratories, as well as contract research organizations, the right LIMS can accelerate sample turnaround, improve operational efficiency, and lower the cost of DMPK and other ADME studies. Thermo Scientific Watson LIMS Software for Bi analytical Laboratories, installed in 18 of the top 20 global pharmaceutical organizations, facilitates efficient study design and data transfer while streamlining assay validation, bioanalysis, instrument interfacing, sample tracking, results reporting, and regulatory compliance.

Thermo Scientific™ Data Manager™ Scientific Data Management System (SDMS)

Thermo Scientific Data Manager SDMS is designed to meet the requirements for securely storing and rapidly retrieving scientific data from multiple instrument formats. Through a unique library of over 150 powerful file converters that automatically generate XML versions of the data, the archived information can be viewed on virtually any platform without using the original instrument software. Data Manager is the most effective solution of its kind for protecting scientific intellectual property and extracting maximum value from past and future R&D activities.

Data Manager easily integrates with existing informatics investments such as LIMS, CDS, ELN, as well as enterprise systems such as ERP, increasing the utility, value, availability, and longevity of scientific data.



Thermo Scientific™ Integration Manager™

By bridging the islands of data generated in the lab and transforming that data into information that can be used across the enterprise, organizations will reap the benefits of improved access to real-time information, regulatory compliance, data integrity, as well as time and cost savings, by automating processes and reducing manual data handling.

Thermo Scientific Integration Manager is a flexible, powerful data transformation tool that translates and consolidates disparate data sources, enabling point-to-point data distribution across the enterprise. With Integration Manager, data generated by any of the instruments, services, or third party applications can be collected electronically and stored in a central database, regardless of the individual output formats produced by each instrument or manual process.

Integration Manager integrates disparate instruments in the laboratory with LIMS (Laboratory Information Systems), ERP (Enterprise Resource Planning), and MES (Manufacturing Execution Systems), allowing users at all levels to access data in a format suitable to their needs.

Versatile ion trap LC-MS systems offer unique capabilities such as MSⁿ and data-dependent analysis along with excellent full-scan sensitivity to provide routine detection and rapid identification of low level analytes.



LCQ Fleet Ion Trap Mass Spectrometer

The cost-effective Thermo Scientific™ LCQ™ Fleet ion trap mass spectrometer delivers rich information for routine analysis of complex samples while providing excellent full-scan sensitivity, ruggedness, and reliability.

- Proven performance for compound identification in complex matrices
- Easy-to-use single-point LC-MSⁿ for non-MS operators



LTQ XL Linear Ion Trap Mass Spectrometer

Thermo Scientific™ LTQ XL™ ion trap LC-MS mass spectrometer delivers high-sensitivity MSⁿ performance to generate extensive structural information for routine proteomics and metabolism applications. Its high-capacity 2D linear ion trap configuration with powerful software is a complete solution for structural elucidation questions. The LTQ XL MS offers multiple dissociation techniques, PQD, ETD and CID.

- PQD is a proprietary technique that eliminates the low mass cut-off concern inherent with all ion traps
- Extensive coverage for predicted and unpredicted metabolites



Velos Pro Ion Trap Mass Spectrometer

With the improved robustness of Generation 2 ion optics, the Thermo Scientific™ Velos Pro™ ion trap mass spectrometer delivers reliability on the fastest, most sensitive, highest capability ion trap available today.

- New detection electronics enable linear quantitation of up to 6 orders of magnitude for enhanced reproducibility and confidence in results
- Fast scanning up to 66,000 Da/sec enables ultra high-throughput analyses, compatible with UHPLC systems
- Trap-HCD fragmentation offers complementary, triple quadrupole-like fragmentation that facilitates structural elucidation, sequence assignment, and quantitation of isobarically labeled peptides

more robust LC-MS Systems

Transform your targeted quantitation. Thermo Scientific™ triple quadrupole LC-MS systems provide maximum quantitative performance and value with ultimate robustness and ease of use.



TSQ Quantiva Triple Quadrupole Mass Spectrometer

The Thermo Scientific™ TSQ Quantiva™ triple quadrupole mass spectrometer with Active Ion Management (AIM) technology delivers unrivaled sensitivity, speed, and dynamic range for scientists facing the most difficult quantitative challenges now and in the future. This extreme performance is achieved with a reliability and ease of operation that help users spend more time thinking about their analyses and less time worrying about instrument setup and operation.

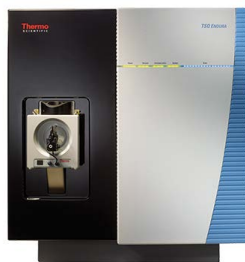

TSQ Endura Triple Quadrupole Mass Spectrometer

The Thermo Scientific™ TSQ Endura™ triple quadrupole mass spectrometer provides unparalleled value, with LODs and LOQs unrivaled in its class. It delivers this best-in-class quantitation run-after-run and day-after-day regardless of sample type or matrix, and it does so with a simplicity that takes the worry out of method development and operation.



TSQ Quantum Access MAX Triple Quadrupole Mass Spectrometer

Applications such as environmental and food safety testing, clinical research, and forensic toxicology demand robust analytical sensitivity and specificity—even when budgets are constrained. The Thermo Scientific™ TSQ Quantum™ Access MAX triple quadrupole mass spectrometer is an outstanding LC-MS/MS value, providing excellent sensitivity, specificity, and flexibility that is also more affordable.

Orbitrap technology is the recognized gold standard for high-resolution, accurate-mass (HRAM) analyses. It is available in a variety of mass spectrometry platforms. The Orbitrap Fusion MS is the ultra-high performance research instrument. The Exactive and Q Exactive MS family takes the advantage of Orbitrap HRAM for both qualitative analyses and routine targeted quantification to non-targeted screening.

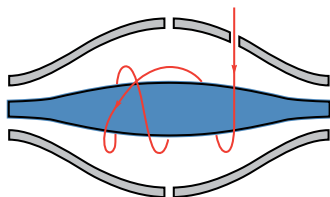

The Technology of Choice for Accurate Mass and High-Resolution Measurement

Since its commercial introduction in 2005, Orbitrap technology has become the recognized standard for routinely achievable ultra-high resolution (>250,000) mass spectrometry with reliable accurate mass. Combined with superior dynamic range and unsurpassed sensitivity, Orbitrap-based platforms are the only LC-MS and MS/MS systems capable of providing all four benefits at the same time, without compromise. The addition of an ion trap mass analyzer to an Orbitrap detector enables multiple levels of fragmentation (MSⁿ) as well as multiple fragmentation modes (CID, HCD, and ETD) for the elucidation of analyte structures. Coupling with continuous ionization sources such as atmospheric pressure chemical ionization source (APCI), electrospray (ESI), or nanoelectrospray (NSI), provides increased analytical flexibility and power.



Exactive Plus Orbitrap Mass Spectrometer

The Thermo Scientific™ Exactive™ Plus mass spectrometer is easy to use, cost effective to operate and, coupled with workflow-driven software, makes an ideal instrument for new users and users performing largely routine analyses. It delivers high-resolution, accurate-mass (HRAM) full-scan MS for fast, precise, and reproducible results and tremendous analytical confidence. The continuous acquisition of HRAM full-scan data allows retrospective data analysis for qualitative and quantitative analyses.



Q Exactive High Performance Benchtop LC-MS Mass Spectrometer

The sensitivity, selectivity, flexibility, and ease-of-use provided by hybrid quadrupole-Orbitrap mass spectrometers set the standard for screening, quantitation, identification, and confirmation of targeted and untargeted compounds. The Thermo Scientific™ Q Exactive™ Focus hybrid quadrupole-Orbitrap MS makes this power accessible to environmental, food safety, clinical research, forensic toxicology, and pharmaceutical labs challenged by growing sample volumes and constrained by strict budgets. The Q Exactive Focus system simplifies method development, saving time and decreasing costs while reliably delivering unsurpassed results.

more resolution Orbitrap LC-MS Systems



Q Exactive Plus Hybrid Quadrupole-Orbitrap Mass Spectrometer

The Thermo Scientific™ Q Exactive™ Plus benchtop LC-MS/MS combines high-performance quadrupole precursor selection with high-resolution, accurate-mass (HRAM) Orbitrap detection to deliver high performance and tremendous versatility. From protein characterization to targeted or DIA-based quantitation and confident DMPK qual/quant screening studies, this system enables you to screen, identify, and quantify compounds in complex samples rapidly.



Q Exactive HF Benchtop Orbitrap Mass Spectrometer

The Thermo Scientific™ Q Exactive™ HF mass spectrometer is the next generation HRAM benchtop system with an ultra-high-field Orbitrap detector, providing greater speed, productivity, and confidence for both qualitative and quantitative omics workflows.



Orbitrap Fusion Lumos Tribrid Mass Spectrometer

The new Thermo Scientific™ Orbitrap Fusion™ Lumos™ Tribrid™ mass spectrometer expands performance in advanced proteomics, biopharma, and metabolomics applications, including quantitation using isobaric tags, low level PTM analysis, data independent acquisition (DIA), and top down proteomics. The new instrument features enhanced sensitivity resulting in improved analyte detection, characterization, and quantitation, enabling scientists to perform more comprehensive sample analyses faster and with better accuracy than ever before.

Our enabling software solutions include enterprise-level offerings for global deployment, as well as software designed to maximize the functionality and efficiencies of our world-class scientific instruments.



Thermo Scientific Mass Spectrometry Software

Thermo Scientific™ Xcalibur™ Software

This flexible Windows®-based data system provides instrument control and data analysis for all Thermo Scientific mass spectrometers. With extensive functionality, the ability to integrate third-party control, and availability of several application-specific modules, Xcalibur software can address a wide range of applications.



Thermo Scientific Application-Specific Software

Proteomics

Thermo Scientific™ Proteome Discoverer™ software: for comprehensive data analysis for qualitative and quantitative proteomics research.

Thermo Scientific™ ProteinCenter™ software: for web-based comparison and interpretation of data sets in minutes for biological information.

Thermo Scientific™ Pinpoint™ software: methods for easy transition from early-stage biomarker discovery to larger-scale, quantitative proteomics.

Thermo Scientific™ ProSight PC™ software: For top-down MS/MS protein identification and automated PTM annotation.

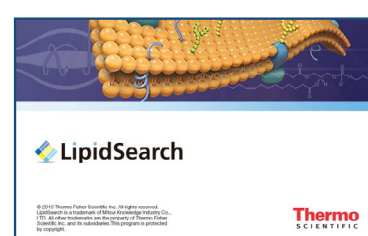

Thermo Scientific Application-Specific Software

Metabolomics and Lipidomics

Thermo Scientific™ SIEVE™: for label-free, semi-quantitative differential expression analysis

Thermo Scientific™ LipidSearch™: for lipid identity and quantitation from Orbitrap data.

Thermo Scientific™ mzCloud™ Advanced Mass Spectral Database: Thermo Fisher Scientific is proud to contribute to a cloud-based HRAM fragmentation library.

Chromatography, MS and LIMS more connected Software

Accelerate the acquisition of high-quality mass spectral data with intuitive, application-specific Thermo Scientific™ MS software, which helps turn that data into answers to the most challenging scientific questions.

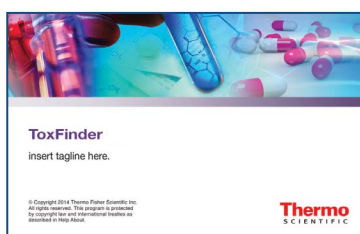
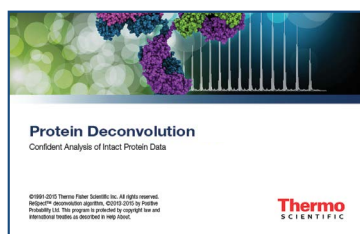

Biopharmaceutical Characterization

Thermo Scientific™ PepFinder™: With this comprehensive peptide mapping software compare expected and unexpected protein modifications, including amino acid substitutions, across samples.

Thermo Scientific™ Protein Deconvolution™: Accurate mass determination for intact proteins for all Orbitrap mass spectrometers.

Thermo Scientific™ SimGlycan™: In combination with multistage fragmentation (MSⁿ) this software provides the most in depth characterization of glycan structures available.

Clinical Research/Forensic Toxicology

Thermo Scientific™ ToxFinder™: for automated LC-MS/MS screening in forensic toxicology.

Thermo Scientific iRCPro: Ion ratio calculation software designed for Thermo Scientific TSQ MS platforms.

General Screening Applications

Thermo Scientific™ TraceFinder™: for all GC/MS an LC/MS quantitation and screening needs, including those who need a 21 CFR Part 11 compliant environment.

Thermo Scientific™ Mass Frontier™: manage, evaluate, and interpret GC and LC mass spectral data.



Trace Elemental Software

Thermo Scientific Qtegra Intelligent Scientific Data Solution (ISDS)

The Thermo Scientific™ Qtegra™ Intelligent Scientific Data Solution™ (ISDS) Software delivers quality and drives productivity. The platform is intuitive and easy to use for routine, high throughput applications, yet offers all the flexibility required for the most demanding applications. As the common ICP software platform, Qtegra ISDS Software reduces training requirements, makes adoption of new instrumentation faster and easier, and allows for increased flexibility for modern multi-technique laboratories.

Award-winning instrumentation for fast, simple and accurate trace element identification. Across the lab we offer the broadest portfolio of instrumentation to identify organic and inorganic elements at ppm to sub-ppt levels. These breakthrough technologies enable scientists in environmental, industrial and health markets to work faster, with confidence and the flexibility to adapt to changing demands.



iCE 3000 Series AAS

Perform efficient, accurate trace elemental analysis with the Thermo Scientific™ iCE™ 3000 Series AAS. With dedicated flame, furnace, or combined flame and furnace options, these fast, easy-to-use and fully automated AAS analyzers are the ideal, low-cost solution for your laboratory requirements.



iCAP 7000 Plus Series ICP-OES

Maximize your analytical performance in routine and research applications. The Thermo Scientific™ iCAP™ 7000 Plus Series ICP-OES delivers the power and flexibility to analyze the most challenging samples. The instrument provides low-cost, multi-element analysis for measuring trace elements in a diverse sample range. A combination of advanced performance, high productivity, and ease of use results in consistently reliable data, so you can ensure compliance to global regulations and standards.



iCAP Q ICP-MS

Whether analyzing ppm to sub-ppt levels in challenging matrices, characterizing compounds, or detecting nanoparticles, with the Thermo Scientific™ iCAP™ Q ICP-MS you can gain complete confidence with accurate results. Analyze the entire mass spectrum in one universal Helium Kinetic Energy Discrimination (He KED) measurement mode and remove interferences with the Thermo Scientific proprietary QCell technology, with flatpole low mass cut off. Thanks to the modular design and seamless integration with a wide variety of autosamplers and peripherals, with the iCAP Q ICP-MS you can solve analytical challenges and future proof your lab, while enjoying minimal maintenance. Extend your ICP-MS capabilities with the coupling to IC systems, for more insights in food and environmental analysis.

more innovation with Trace Elemental Analysis solutions



ELEMENT 2/XR HR-ICP-MS

Gold standard in ICP-MS performance, for superior data confidence. The Thermo Scientific™ ELEMENT 2 and XR High Resolution (magnetic sector) ICP-MS systems cover the sub-ppq to ppm concentration range. They provide class-leading elimination of interferences for accurate and reliable quantitative multi-element analyses at trace levels, even without sample preparation. This makes them especially suitable for the metrology and analytical standards industry as well as semiconductor, geological, and material science laboratories. The Jet Interface for the ELEMENT 2/XR HR-ICP-MS sets a new standard in sensitivity for ultratrace elemental analysis.



ELEMENT GD PLUS GD-MS

Defining quality standards for the analysis of solid samples. The Thermo Scientific™ ELEMENT GD PLUS Glow Discharge Mass Spectrometer (GD-MS) redefines the analysis of advanced high-purity materials directly from the solid. Extra-low detection limits are provided with minimum calibration and sample preparation effort, making bulk metal analysis and depth profiling applications the domain for GD-MS. Ceramics and other non-conductive powders are analyzed by using a pulsed source approach, providing the same level of sensitivity and data quality. This makes GD-MS the reliable standard method for metal analysis.



FLASH 2000 Elemental Analyzer

Simplify your CHNS/O analysis with the Thermo Scientific™ FLASH™ 2000 Organic Elemental Analyzer (OEA) and discover how it solves your laboratory challenges, improves workflow, and minimizes downtime. The FLASH 2000 Elemental Analyzer delivers the ultimate performance in simplicity, precision, and cost effectiveness for any laboratory requiring the quantification from few ppm to 100% of carbon, hydrogen, nitrogen, sulfur, and oxygen. Providing a reliable, high-speed, accurate 24/7 analytical solution to a range of industries, the flexible, configurable organic elemental analyzer uses a globally recognized technique, endorsed by official organizations worldwide.

Achieve unique information, such as origin, history, and age, from your samples with the unsurpassed precision and sensitivity in isotope ratio measurements afforded by Thermo Scientific™ isotope ratio mass spectrometers.



Isotope Ratio Infrared Spectrometry

Utilize state-of-the-art mid-infrared spectroscopy with the Thermo Scientific™ Delta Ray™ Isotope Ratio Infrared Spectrometer (IRIS) that enables simultaneous determination of concentration, $\delta^{13}\text{C}$ and $\delta^{18}\text{O}$ of CO_2 at ambient concentrations with a precision as low as 0.05%. This analyzer empowers you to make profound scientific discoveries in a wide variety of research fields like greenhouse gas monitoring, ecology and plant science, volcano monitoring, carbon storage, and sequestration.

- Verifiable and precise
- Field deployable
- Continuous, feature rich data 24 hours a day, 7 days a week
- Simultaneous $\delta^{13}\text{C}$, $\delta^{18}\text{O}$ and concentration of CO_2
- Smart referencing



Gas Isotope Ratio MS

Measure isotopic signatures with extreme precision and sensitivity to provide the unique insight into the history and origin of compounds with Thermo Scientific isotope ratio mass spectrometry.

- Combine all isotope ratio mass spectrometry (IRMS) applications in a single analyzer. The Thermo Scientific™ Delta V™ IRMS systems combine outstanding sensitivity with excellent linearity and stability to address applications as diverse as the detection of honey adulteration by EA-IRMS to $\delta^{13}\text{C}$ analysis of PAHs in soil with GC-IRMS.
- Get the highest sensitivity and precision for the determination of isotope ratios with the Thermo Scientific™ MAT 253™ stable isotope ratio mass spectrometer. It provides a flexible and open platform for the connection of inlet systems and preparation devices for the smallest amounts of sample in IRMS.



High Resolution Isotope Ratio MS

Discover a new world of mass spectrometry. The Thermo Scientific™ 253 Ultra™ high resolution isotope ratio mass spectrometer revolutionizes the measurement of site-specific and clumped-isotope-ratio analysis of intact molecules. Analysts now get direct access to the conditions under which molecules were formed and how they were transported, stored, and degraded. This will enable new discoveries in climate research, biochemistry, forensics, oil, and gas exploration.

more sensitivity Isotope Ratio Mass Spectrometry



Multicollector ICP-MS

Meet the ever-expanding application demands of earth sciences, nuclear sciences, and other fields requiring high-precision isotope ratio measurements with the Thermo Scientific™ Neptune Plus™ high-resolution multicollector ICP-MS system. The Neptune Plus system combines field-proven technology with the latest innovations. This powerful double-focusing mass spectrometer, with high mass resolution, variable multicollectors, and multi-ion counting capability, offers groundbreaking sensitivity, high dynamic ranges, unsurpassed linearity, and robust stability.



Thermal Ionization MS

Get high-precision isotope ratio measurements of your precious samples with the Thermo Scientific™ Triton Plus™ multicollector thermal ionization mass spectrometer (TIMS). With a proven thermal ionization source and a unique variable multicollector system that can be configured to suit the application, the Triton Plus TIMS system is ideal for dating of geological samples and control of isotopic compositions of nuclear materials. It has outstanding sensitivity, dynamic range, linearity, and stability.



Noble Gas MS

Take the next step in noble gas mass spectrometry. The new series of Thermo Scientific™ noble gas mass spectrometers gives you unsurpassed precision, sensitivity, dynamic range, linearity, and stability.

- Improve age precision in Ar-Ar dating by an order of magnitude. Get all five argon isotopes simultaneously with the Thermo Scientific™ Argus VI™ static vacuum noble gas mass spectrometer.
- Redetermine the isotope ratios of neon, argon, krypton, and xenon by unsurpassed high resolution and precision of the Thermo Scientific™ Helix MC Plus™ multicollector noble gas mass spectrometer.
- Enter new fields of research with unique subpermil precision by using the new Thermo Scientific™ Helix SFT™ split flight tube noble gas mass spectrometer.

Omics research is accelerating the conversion of basic scientific knowledge into potential tests, treatments, and practices that improve human, animal, and plant health. Whether you are using proteomics, glycomics, metabolomics, or lipidomics approaches, we are committed to advancing research. With our knowledgeable application scientists, innovative mass spec solutions, and key opinion leaders, we bring you the most current approaches and thinking in this field.

Proteomics

- Top-down proteomics
- Bottom-up proteomics
- PTM analysis
- Intact protein characterization
- Targeted quantitation

Metabolomics

- Untargeted analysis
- Targeted analysis

Glycomics

- Intact glycoprotein profiling
- Glycan ID and characterization
- Glycan quantitation
- PTM glycosylation

Lipidomics

- Untargeted analysis
- Targeted analysis
- Shotgun lipidomics
- Lipid structural elucidation

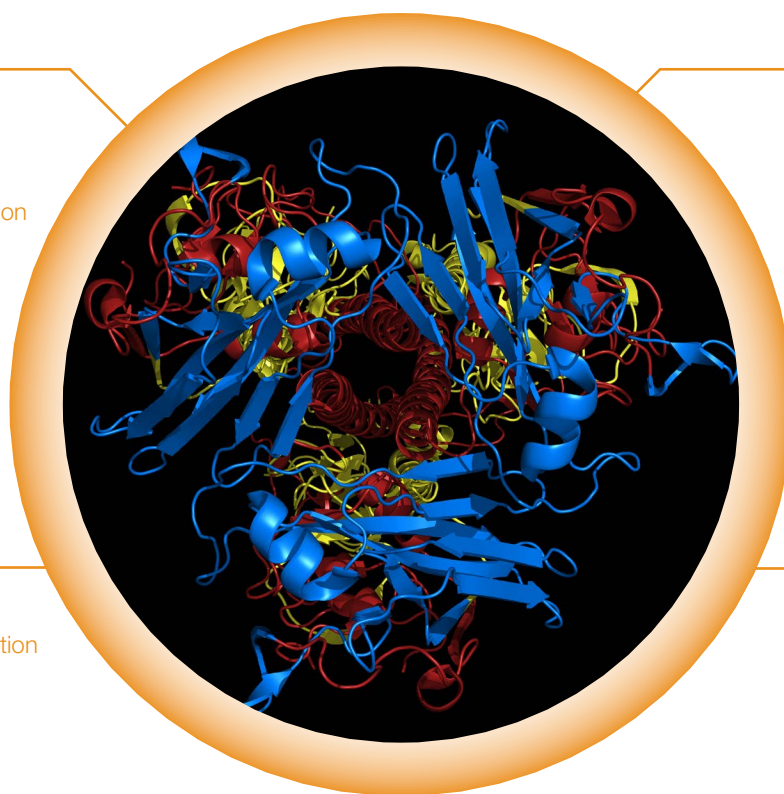

Transforming Your Science Omics Research Solutions

W O R K F L O W

Sample Preparation

Simplify, speed up, and automate sample preparation to increase productivity and reduce the cost per sample.

Sample Analysis

Rapidly separate, detect, and quantify complex samples with industry-leading mass spec solutions. Perform both qualitative and quantitative analyses using high-resolution, accurate-mass Orbitrap systems and SRM analyses with triple quadrupole MS.

Data to Results

With application-specific software solutions, turn data into answers to the most challenging scientific questions.

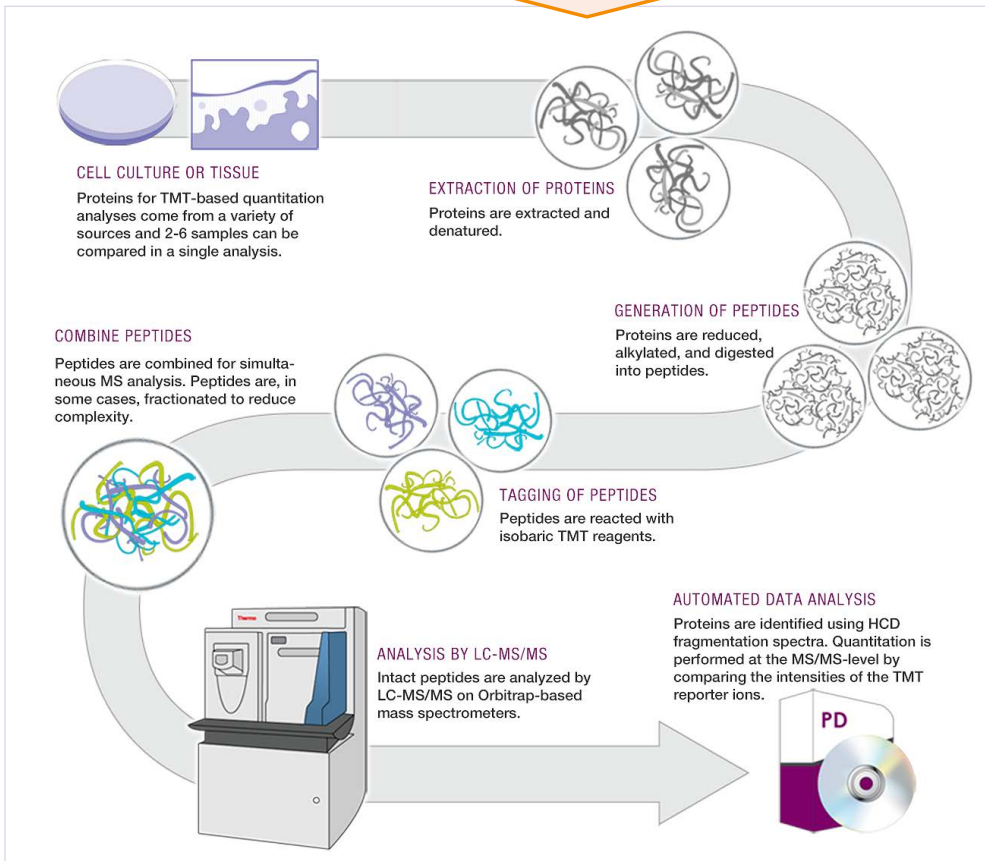

Visit planetorbitrap.com for more info on TMT workflows

There's a revolution in the biopharmaceutical industry. Biotherapeutic medicines are now the fastest growing market segment of the pharmaceutical industry, growing at over 12% per annum. Furthermore, seven out of the top ten drugs by dollar value are biotherapeutics. But discovery, development, and quality control of these large heterogeneous molecules is extremely challenging. That's where Thermo Fisher Scientific can help.



Transforming Your Science Biopharma and Pharma

Drug
Discovery



Drug Discovery

Drug
Development



Drug Development

Pre-clinical and Clinical
Drug Testing



Pre-Clinical &
Clinical Drug Testing

Pharmaceutical
QA and Control



Pharmaceutical QA/QC

Thermo Fisher Scientific offers a uniquely broad portfolio of platforms and solutions to meet your analytical needs, from discovery to QA/QC. Whether you are screening your clones for efficacy or undertaking a full characterization of the glycosylation patterns of your antibodies, we've got the solution. Join the community at: [thermoscientific.com/en/community/pharma-biopharma.html](https://www.thermoscientific.com/en/community/pharma-biopharma.html)

The right platforms for your analytics

UHPLC columns

We have the broadest possible range of columns for biologics separation and characterization, including unique, highly specific multi-mode columns such as GlycanPac.



LC

Maximize your liquid chromatography separations with the fast, flexible, and powerful range of Thermo Scientific UHPLC systems, including the next generation Vanquish UHPLC.



Orbitrap mass spec

Rapidly analyze highly complex proteins, such as monoclonal antibodies, with incredible detail using Orbitrap technology, the most powerful in the industry.



Informatics platforms

Control your instruments and deconvolute your data using our wide range of informatics and software platforms.



We work with our clients to create a healthier, safer, and cleaner environment for everyone by helping to guarantee clean drinking water through environmental monitoring, preserving raw water sources, and ensuring the optimal operation of both industrial and municipal water purification processes. At Thermo Fisher Scientific we bring environmental analysis together.

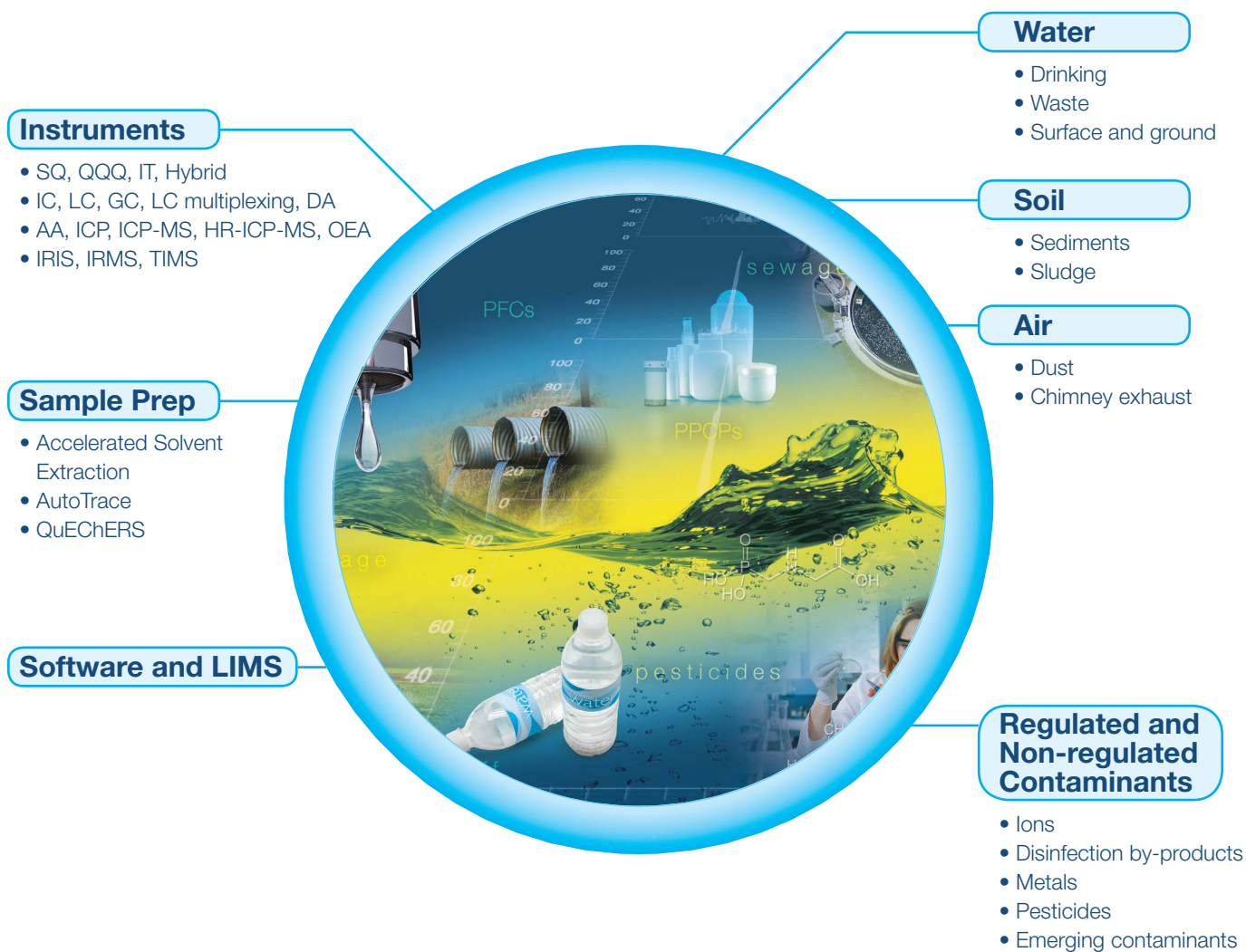

Transforming Your Science Environmental Analysis

W O R K F L O W

Sample Preparation

Simplify, speed up, and automate sample preparation to increase productivity and reduce the cost per sample.

Sample Analysis

Rapidly separate and detect complex samples with industry-leading brands and innovations like Orbitrap, Vanquish, Dionex, and Liquid, Gas, Elemental, Automated Photometry, and Mass Spectrometry solutions.

Data Management

Manage data with software solutions including enterprise-level offerings as well as software to maximize the functionality and efficiencies of your instruments.

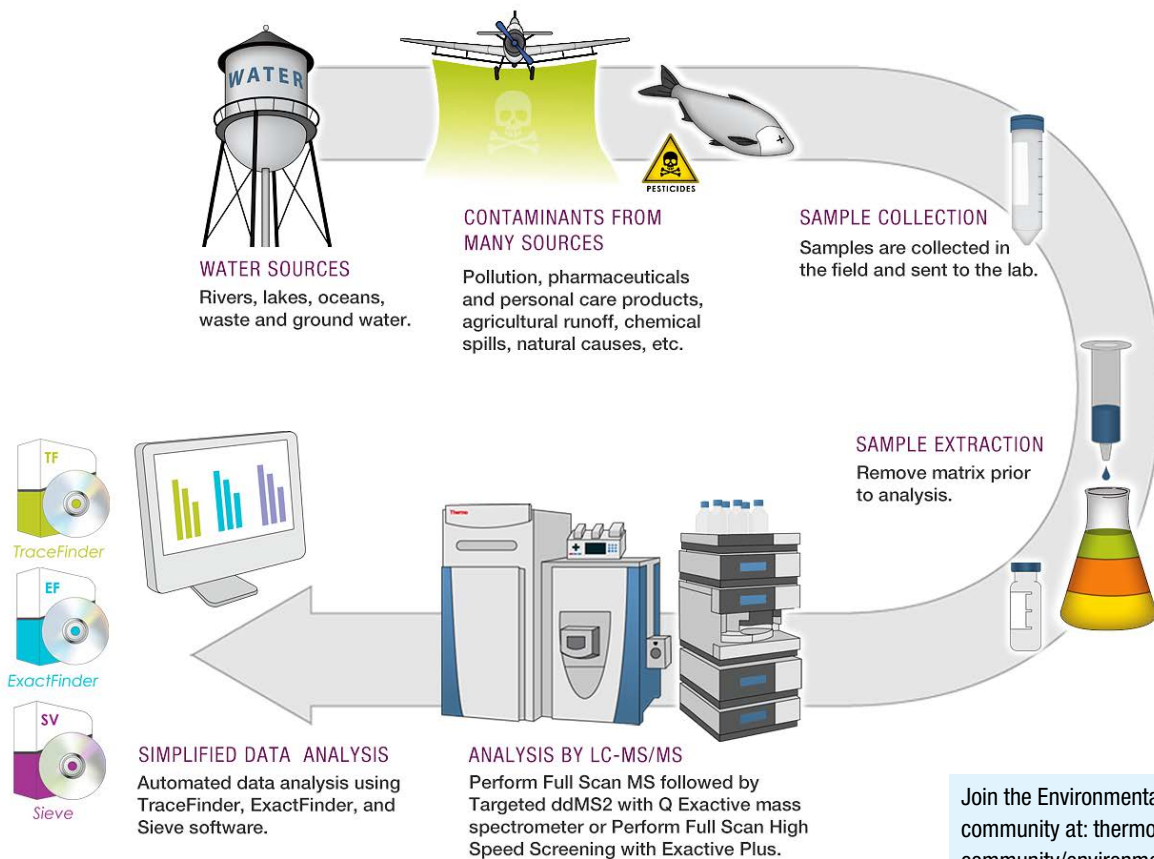

Join the Environmental and Industrial community at: thermoscientific.com/en/community/environmental

Those who focus on ensuring the safety and quality of food face increasing challenges. Whether you are testing for contaminants or developing a new production process, we are here to help. Our knowledgeable employees, innovative products, and a range of solutions allow our customers to maintain their focus where it should be – on delivering safe, high-quality food products that consumers expect.

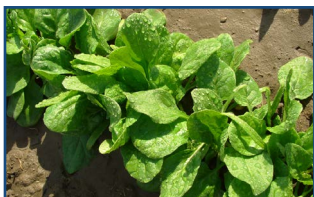

Food Safety



**Food Authenticity
Adulteration, Fraud**



Food Quality and Labeling



Nutraceuticals

Matrices



Pesticide Residues, Veterinary Drug Screening, Targeted Analysis, Speciation, Nutritional and Food Label Testing, Adulteration and Authenticity, Extractible and Leachables

Vitamin, Organic/Inorganic Acids, Carbohydrates, Fats & Lipids, Colors and Flavors, Metals, and more....

Transforming Your Science Solutions for Food and Beverage Testing

W O R K F L O W

Sample Preparation

Simplify, speed up, and automate sample preparation to increase productivity and reduce the cost per sample.

Sample Analysis

Rapidly separate and detect complex analyte mixtures in samples with industry-leading brands and innovations like Orbitrap, Vanquish, Dionex, and Liquid, Gas, Elemental, Automated Photometry, and Mass Spectrometry solutions.

Data Management

Manage data with software solutions including enterprise-level offerings as well as software to maximize the functionality and efficiencies of your instruments.

Example of Pesticides Analysis Workflow using LC-MS

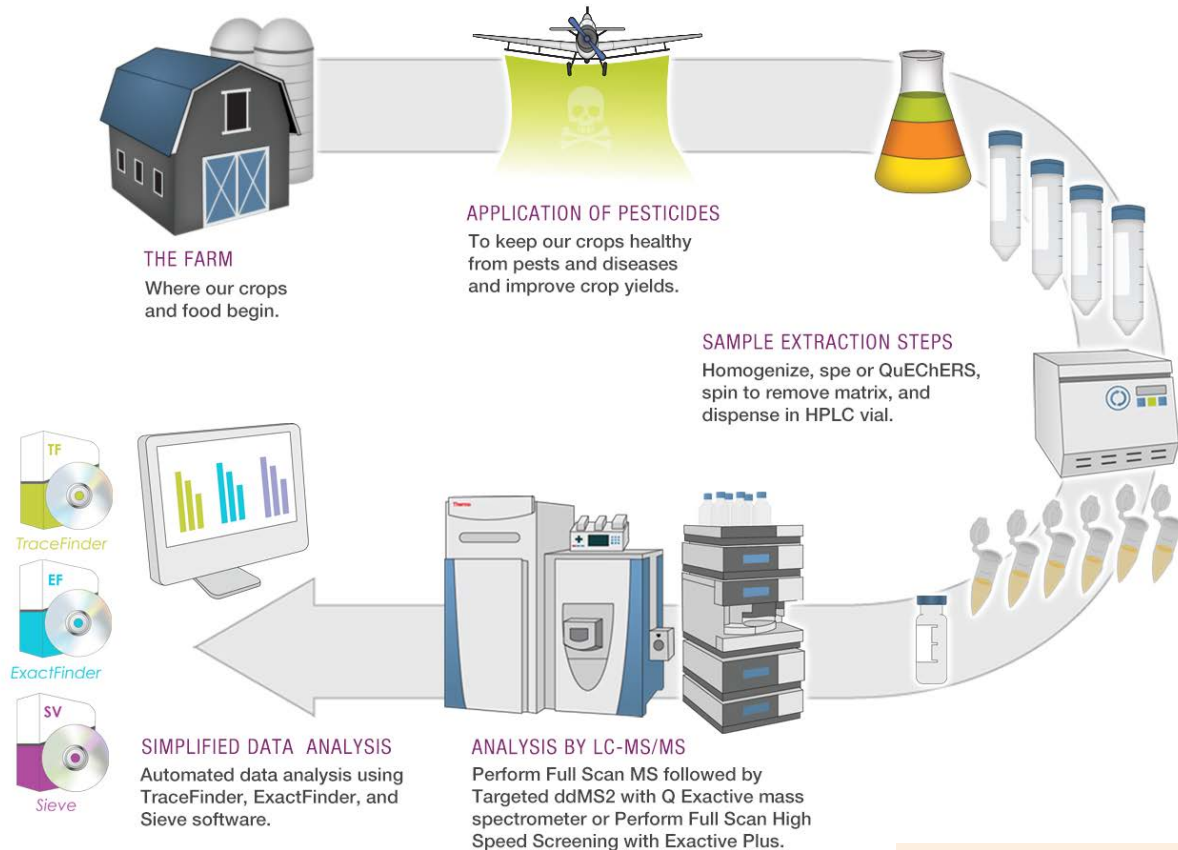

Join the Food Community at:
thermoscientific.com/en/community/food-beverage

FORENSICS

All forensic laboratories are not created equal. Whether you need to screen and confirm known compounds, identify unknowns, or advance forensic research, we offer a solution to meet your current and future needs, while helping your laboratory analysts with first time test success.



Toxicology

Solutions to solve your new problems.

We help improve lab efficiency, while staying ahead of tomorrow's illicit drug compounds.



Antidoping

Helping you keep sports true.

Our systems and customers demonstrate the specificity, sensitivity, and dynamic range for the substances you monitor.

WORKFLOW

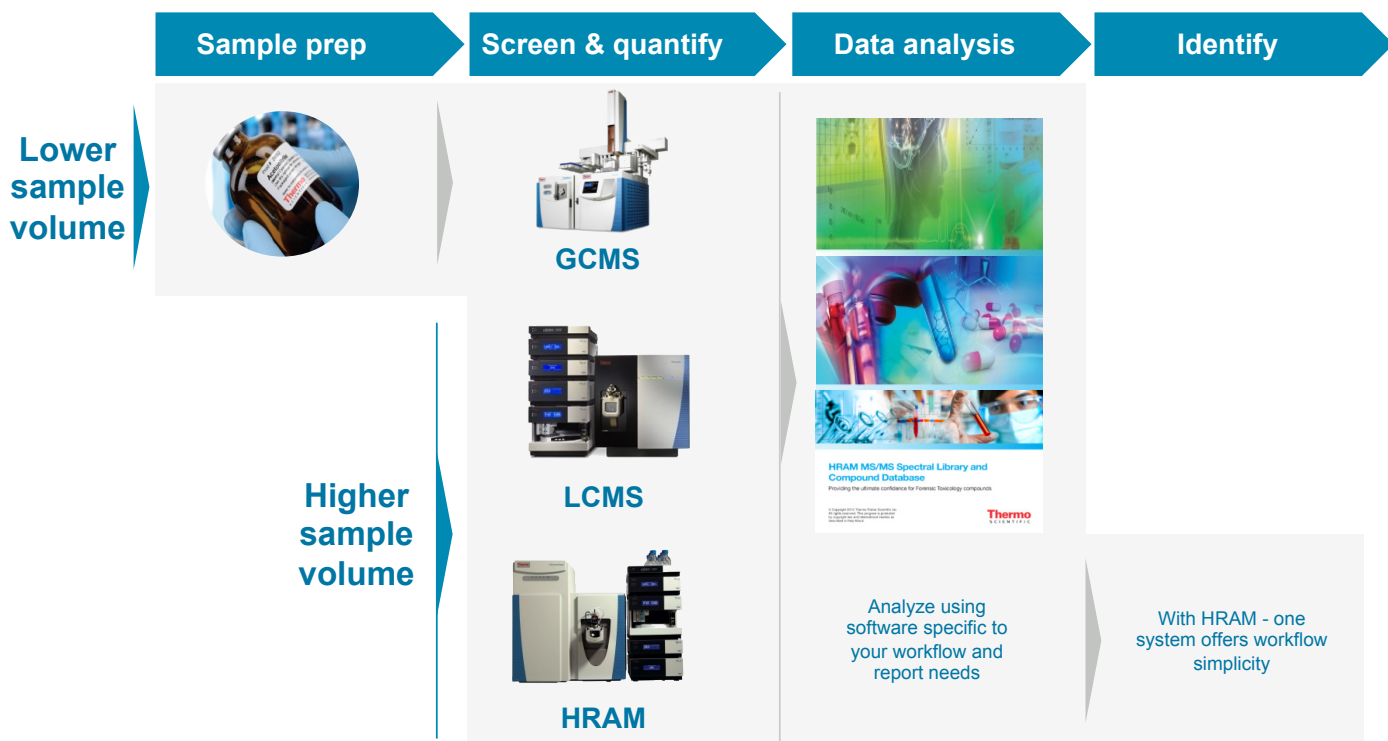

Learn more at <http://www.thermoscientific.com/en/community/forensics-safety-security>

Transforming Your Science Clinical and Forensics

CLINICAL AND TRANSLATIONAL RESEARCH

With more than 70% of medical decisions based on lab test results and a steady increase of mass spectrometry applications, we know how important the answers you generate can be.



Connect science and health in unimaginable ways

Mass spectrometry is transforming the future of healthcare by enabling more accurate and sensitive results in areas never imagined. Our solutions support your continued research and understanding in biomarker, endocrine, inborn metabolism, pharmacology and drug monitoring, wellness, and trace element exposure.

WORKFLOW

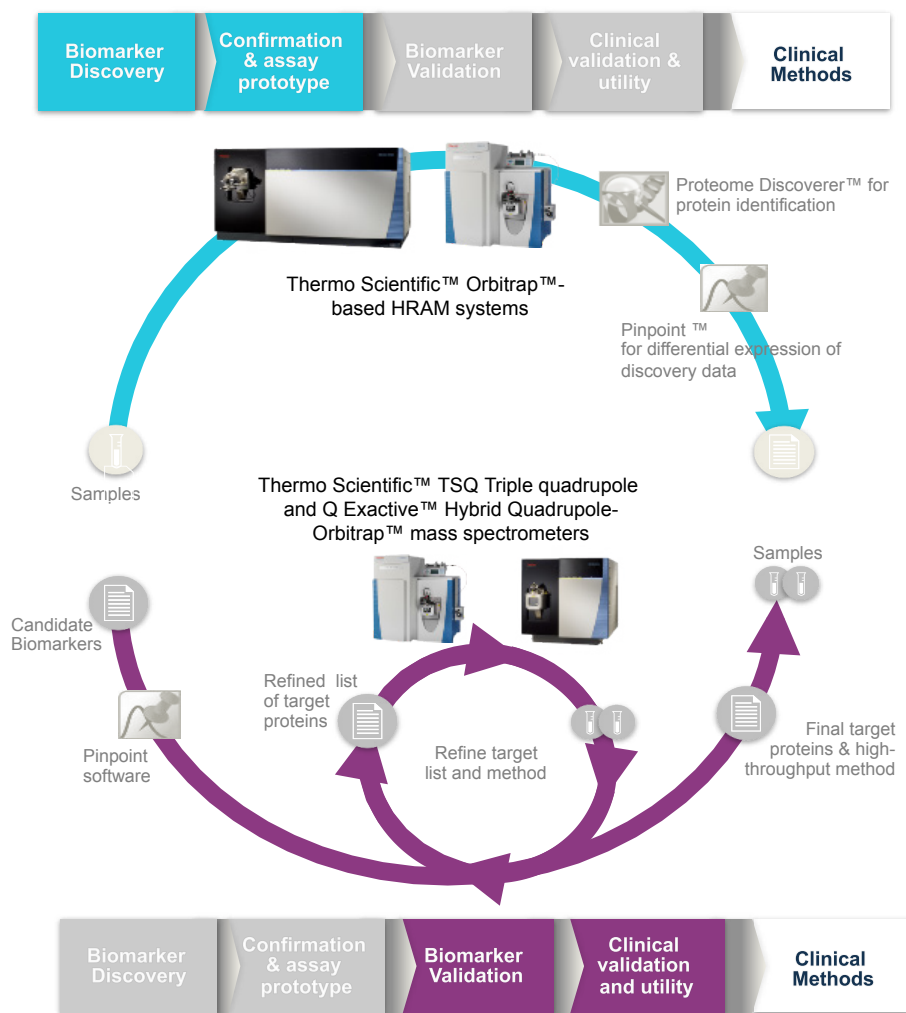

Learn more at <http://www.thermoscientific.com/en/community/diagnostics-health-care>

Unity Lab Services provides a single source for integrated lab service, support, and supply management. Our customized service offerings and world-class service experts have the flexibility and experience to uniquely address your business needs. Whether you are looking to arrange for service on one instrument, or are seeking resources to manage service and support for all your labs, there is a Unity Lab Services solution to meet your business needs.

Instrument Level Services

Instrument Services

- Instrument Level Support Plans
- Parts, Consumables, and Accessories
- Training Courses
- Depot Services

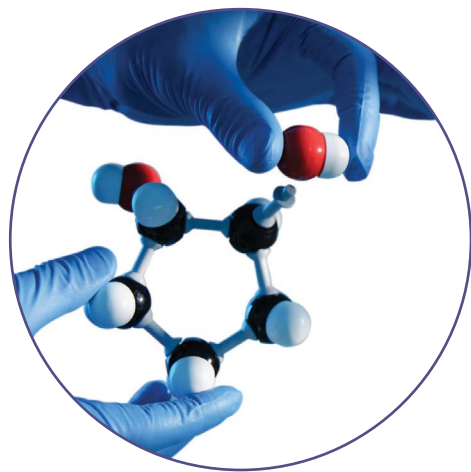

Services Offered at the Lab, Site, or Enterprise Level

Consulting Services

- Needs Assessment
- SmartRelocation: Laboratory Relocation Services
- Training Programs

Asset Management Services

- Complete Multi-Vendor Instrument and Equipment Service Management
- Contract Management
- On-Site Technical Site Manager and/or Service Engineers
- Asset Tracking and Utilization

Supply Management Services

- Order Management
- Dock Management
- Inventory Management
- Chemical Management

Scientific Support Services

- Media Preparation
- Glassware Washing and Management
- Gas Cylinder Management
- Garment Management

Transforming Your Science Service and Support



Simplify Service

- One contract, One solution, One call.

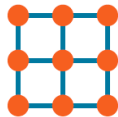

Maximize Resources

- Tap into our expert resources, tools, and dedicated service professionals and multiply the resources available to your lab.



Boost Uptime

- Dramatically improve response times and first-time fix rates with well-managed preventative maintenance, accelerated service response, and accessible supplies.



Reduce Costs

- Experienced teams consolidate service delivery to best meet your needs and deliver cost efficiencies.



Increase Productivity

- Uncomplicated access to the highest quality instrument and laboratory services to spend more time on discovery, less on anything else.





Drive Decisions



- Consistent processes and detailed metrics support swift, intelligent business

Follow Us

The latest chromatography and mass spectrometry solutions and news

-  analyteguru.com
-  facebook.com/ChromatographySolutions
-  [@ChromSolutions](https://twitter.com/ChromSolutions)
-  facebook.com/CharlieLovesChromatography
-  youtube.com/ChromSolutions
-  pinterest.com/Chrom_Mass_Spec
-  instagram.com/chrom_mass_spec
-  plus.google.com/+thermoscientific

The latest spectroscopy solutions and news

-  [Thermo Scientific Spectroscopy Channel](https://youtube.com/ThermoScientificSpectroscopyChannel)
-  [Thermo Scientific Molecular Spectroscopy](https://facebook.com/ThermoScientificMolecularSpectroscopy)

Everything you need for Thermo Scientific solutions and news

-  [@thermosci](https://twitter.com/thermosci)
-  acceleratingscience.com
-  youtube.com/thermoscientific2
-  facebook.com/thermoscientific

©2016 Thermo Fisher Scientific Inc. All rights reserved. All trademarks are the property of Thermo Fisher Scientific and its subsidiaries. Specifications, terms and pricing are subject to change. Not all products are available in all countries. Please consult your local sales representative for details.

Africa +43 1 333 50 34 0
Australia +61 3 9757 4300
Austria +43 810 282 206
Belgium +32 53 73 42 41
Brazil +55 11 2730-3006
Canada +1 800 530 8447
China 800 810 5118 (free call domestic)
400 650 5118

Denmark +45 70 23 62 60
Europe-Other +43 1 333 50 34 0
Finland +358 10 3292 200
France +33 1 60 92 48 00
Germany +49 6103 408 1014
India +91 22 6742 9494
Italy +39 02 950 591

Japan +81 45 453 9100
Korea +82 2 3420 8600
Latin America +1 561 688 8700
Middle East +43 1 333 50 34 0
Netherlands +31 76 579 55 55
New Zealand +64 9 980 6700
Norway +46 8 556 468 00

Russia/CIS +43 1 333 50 34 0
Singapore +65 6289 1190
Spain +34 914 845 965
Sweden +46 8 556 468 00
Switzerland +41 61 716 77 00
UK/Ireland +44 1442 233555
USA +1 800 532 4752

Thermo
SCIENTIFIC

A Thermo Fisher Scientific Brand