

Solutions for

# Environmental Analysis

Application Notebook



# Solutions for Environmental Analysis

Application Notebook

## Introduction

A clean environment is the basis for any life on earth. Whether water, soil or air – keeping the environment clean for the protection of all creatures is, and should be, the primary responsibility of any society. With the continued policy to contribute to society through science and technology, Shimadzu has been specializing in the development of instruments for environmental analysis for decades to help scientists detect and identify trace-level pollutants. These include chromatography (GC, LC, SFC), mass spectrometry (GC-MS, LC-MS, MALDI), sum parameter (TOC), and spectroscopy (UV-Vis, FTIR, AAS, ICP-OES). These high-quality analytical products underline Shimadzu's brand statement of 'Excellence in Science'.

To aid in your environmental analyses, we have compiled a vast number of solution-oriented application notes and information brochures into this notebook. The contents are arranged by analytical targets and techniques to provide an indication of where environmental analytical challenges occur and how to solve them to increase efficiency, productivity and accuracy. In addition, information on various environmental regulations and guidelines, such as the Japan's water quality standards and the widely-adopted US EPA methods and standards, are referenced in the application notes to assist in your analysis for environmental monitoring and regulatory compliance.



## Drinking and Tap Water Analysis

### GC and GCMS

#### **Analysis of Volatile Organic Compounds (VOCs) in Water using Nexis GC-2030 and Headspace Sampler HS-10**

18 VOCs in water were successfully separated and analyzed using Nexis GC-2030 equipped with electron capture detector (ECD) and HS-10.

#### **Shimadzu Guide to BFB Tuning for Analysis of VOCs**

Using the described tune conditions for the Shimadzu GCMS produces reliable instrument performance and BFB Tune Evaluations.

#### **Shimadzu Guide to US EPA Methods 524.3 and 524.4 for Analysis of VOCs in Drinking Water**

The use of an 8-port valve and autosampler in conjunction with Shimadzu's GCMS-QP2010 SE was introduced and evaluated for the analysis of VOCs using US EPA Methods.

#### **Ultra-Fast Analysis of VOCs in Water by Headspace-GC-MS/MS**

This application note illustrates the fast VOCs analysis (up to 8 water samples per hour) and high sensitivity (0.1ppb) using the GC-MS/MS in the MRM mode.

## LC and LCMS

#### **Analysis of Bromate in Tap Water Using a Triple Quadrupole LC-MS/MS**

This method introduces the use of anion exchange column in LC-MS/MS for the analysis of bromate in tap water.

#### **Analysis of Phenols in Drinking Water Using Triple Quadrupole LC-MS/MS**

The use of UHPLC/MS/MS for the quantitative analysis of the six phenols is a simplified alternative to the usual GC/MS technique.

#### **Analysis of Formaldehyde by the Derivatization – High Performance Liquid Chromatography Method, in Compliance with Water Quality Standards**

In compliance to Japan's ministerial ordinance for water quality standards, this example introduces the standard analytical method for the analysis of formaldehyde using Shimadzu's HPLC.

#### **Analysis of Formaldehyde in Drinking Water Using Triple Quadrupole LC-MS/MS**

This application illustrates the sample pretreatment work flows and LC-MS/MS analytical conditions for the analysis of formaldehyde and acetaldehyde in drinking water.

#### **Analysis of Cartap, Pyraclonil, and Ferimzone in Drinking Water Using a Triple Quadrupole LC-MS/MS System**

A LC-MS/MS method was developed for the quantitation of these widely-used agricultural insecticides in drinking water.

#### **Analysis of Glufosinate, Glyphosate and AMPA in Drinking Water Using a Triple Quadrupole LC-MS/MS System**

2 herbicides and their metabolite were monitored for quality control of drinking water using LCMS-8050.

#### **Analysis of Iminoctadine, Paraquat and Diquat in Tap Water Using Triple Quadrupole LC-MS/MS**

Simultaneous analysis using SPE and LC-MS/MS was successfully developed for the pesticide analysis.

#### **Analysis of Haloacetic Acids in Drinking Water Using Triple Quadrupole LC-MS/MS**

The LC-MS/MS method for the analysis of haloacetic acids provides a higher sample throughput and simplicity as compared with the convention GC/MS method.

#### **Shimadzu's Liquid Chromatography Mass Spectrometer LCMS-8060 [Flyer]**

## Surface and Ground Water Analysis

### GC and GCMS

#### **High-Sensitivity Analysis of Nonylphenol in River Water Using GC-MS/MS**

The selective detection of thirteen 4-Nonylphenol isomers was achieved with the highly sensitive GC-MS/MS.

#### **Shimadzu Guide to US EPA Method 8260 for Analysis of VOCs in Ground Water and Solid Waste**

The separation of 99 VOCs in ground water and solid waste was achieved in less than 13 minutes and superior MDLs, precision and accuracy were obtained for these VOCs at multiple concentrations.

#### **Shimadzu's Smart Environmental Database – an environmental pollutants database for GCMS Analysis [Flyer]**

## LC and LCMS

### **A High Sensitivity Method for Quantitative Determination of Ten Phenols in Surface Water on LC-MS/MS with APCI Interface**

A MRM-based LC-APCI-MS/MS method with fast gradient elution was developed for the quantitation of ten phenols in surface water.

### **Quantitative Analysis of Residual Artificial Sweeteners in Surface Water by Highly Sensitive LC-MS/MS Method**

The described LC-MS/MS method, without any sample enrichment steps, achieves fast elution and ng/L level sensitivity for the direct quantitation of five artificial sweeteners in surface water.

### **A Highly Sensitive MRM-Based Method for Detection and Quantitation of Seven Pharmaceuticals and Personal Care Products (PPCPs) in Surface Water**

Quantitative determination of seven PPCPs in surface water was demonstrated using the highly sensitive MRM method in LCMS-8060.

## Spectrophotometry

### **Quality Analysis of Environmental Water**

A water analysis program designed for use with the UV-1280 UV-VIS spectrophotometer provides simple quality analysis of environmental water.

### **Quantitative Analysis of Oil and Grease in Water Using FTIR Based on ASTM D7575**

Parts-per-million quantity of oil and grease in water environment can be easily determined without the need for solvent extraction through this analysis method.

## Spectroscopy for Elemental Analysis

### **Measurement of Arsenic and Selenium in White Rice and River Water by Hydride Generation – Atomic Absorption Spectrometry (HG-AAS) with Electric Cell Heating**

Shimadzu's AA-7000 system with electrically heated hydride generation was used to analyze As and Se in food and environmental water with high sensitivity, without the need for gas supplies.

## Waste Water Analysis

### GC and GCMS

#### **Shimadzu Guide to US EPA Method 624 for Analysis of VOCs in Wastewater**

This guide demonstrated outstanding precision, accuracy and method detection limits for the separation of 37 VOCs using Shimadzu's instrumentation and analytical conditions .

## Spectrophotometry

### **Measurement of Hexavalent Chromium in Chromate Conversion Coating and Metal Ions in Eluate**

The described water analysis program for use with the UV-1280 can easily test for 39 water quality items and 22 water quality species including hexavalent chromium and lead in waste liquids.

### **Analysis of Minor Components in Water Using the IRSpirit**

This describes a difference spectrum method and sample condensation technique together with the use of the IRSpirit to successfully detect minor organic compounds in aqueous solutions.

## Spectroscopy for Elemental Analysis

### **Analysis of Heavy Metals in Sewage Sludge and Sewage by ICPE-9820**

High throughput and highly sensitive and accurate analysis of elements at trace levels was made possible with the use of inductively coupled plasma – atomic emission spectrometer (ICPE-9820).

## Air Analysis

### GC and GCMS

#### **Trace Impurity Analysis of Hydrogen Fuel in Fuel Cell Vehicle-Related Field**

This introduces a high-sensitivity analysis of CO in H<sub>2</sub> and simultaneous analysis of impurities in H<sub>2</sub> using the Tracera high-sensitivity GC equipped with a barrier discharge ionization detector.

#### **High Sensitivity Simultaneous Analysis of Inorganic Gases and Light Hydrocarbons Using Nexis GC-2030 Dual BID System**

The use of a dual capillary column system was demonstrated to enable faster and higher separation analysis of inorganic gases and light hydrocarbon in a single run.

#### **Analysis of Lower Aliphatic Aldehydes Using Nexis GC-2030**

Starting from sample collection, the trace analysis of lower aliphatic aldehydes using Nexis GC-2030 with Flame Thermionic Detector (FTD) were described in this application news.

#### **Analysis of SF<sub>6</sub> Insulation Gas Using a GC-BID System**

Shimadzu's Barrier Discharge Ionization Detector (BID) offers comparable stability and high sensitivity analyses and example analyses of SF<sub>6</sub> and its decomposition products were demonstrated.

#### **Shimadzu's Nexis GC-2030 – The Next Industry Standard [Flyer]**

## Gas Analyzer

#### **Evaluation of a Catalyst Used in the Production of Fuel Cell Hydrogen with CGT-7100**

Direct and real-time measurement of CO, CO<sub>2</sub> and CH<sub>4</sub> can be achieved using CGT-7100 gas analyzer.

## Soil Analysis

### LC and LCMS

#### **Quantitative Analysis of Pyrethroids in Soil and Sediment Using the Shimadzu LCMS-8050 Triple Quadrupole Mass Spectrometer**

Simultaneous positive and negative-ion mode analysis of 14 pyrethroid pesticides was demonstrated using LC-ESI-MS/MS.

#### **Application of Nexera UC SFE Pretreatment System for Extracting Pesticide Residues from Soil**

This application illustrated the superb efficiency of supercritical fluid extraction and analysis of the extracted pesticides in MRM mode using LC-MS/MS.

## Spectroscopy for Elemental Analysis

#### **Content Analysis of Toxic Elements in Soil by ICPE-9800 Series**

Shimadzu's ICPE9800 and the described analytical method demonstrated a low cost, quick and accurate trace elemental analysis in soil.

## Other Environmental Analysis

### GC and GCMS

#### **Improvement of Sensitivity and Repeatability in Analysis of Formic Acid**

An example of high sensitivity analysis of formic acid in various organic solvents was illustrated using a gas chromatography – barrier discharge ionization detector (GC-BID).

#### **High-Sensitivity Analysis of Formic Acid Using GC-BID in Artificial Photosynthesis Research**

The use of GC-BID for the analysis of formic acid allows direct measurement without dilution and high sensitivity detection at low ppm level.

#### **High-Sensitivity Analysis of Ammonia, Methylamine and Trimethylamine in Environmental and Energy Fields**

The analysis of ammonia, methylamine and trimethylamine at ppm level in water was determined using the high sensitivity GC-BID.

#### **Analysis of Thiophene in Benzene Using Nexis GC-2030**

The Nexis GC-2030 equipped with the high sensitivity flame photometric detector (FPD) provides high sensitivity and high stability analysis of sulfur content in petroleum products.

#### **Examples of Analyzing Organic Compound Species with Hydrogen Carrier Gas using Nexis GC-2030**

Several mixed organic compounds solution was analyzed with hydrogen carrier gas using the Nexis GC-2030 equipped with a hydrogen sensor.

#### **Example Analysis Using a Highly Sensitive Trace Moisture Analysis System – Measurement of Moisture in Chlorofluorocarbon Gas and High-Purity Nitrogen Gas**

The highly sensitive trace moisture analysis system employs a sampling system that can successfully prevent the inclusion of water at the time of sample injection.

#### **A Pyrolysis-GCMS Screening System for Analysis of Phthalate Esters and Brominated Flame Retardants**

The described Pyrolysis- GCMS method offers minimal sample preparation for the screening and analysis of phthalate esters and brominated flame retardants in polymer matrix.

### **Spectrophotometry**

#### **Simplified Measurement of Coumarin in Diesel Oil**

A quick and easy spectrophotometry method used to accurately measure coumarin in oil.

### **Total Organic Carbon (TOC) Analysis**

#### **TOC/TN Measurement for the Control and Evaluation of Methane Fermentation of Food Waste Using TOC and TC Measurement System**

This example describes the use of Shimadzu TOC combustion analyzer and TN unit to effectively measure these parameters for the control and evaluation of methane fermentation processes.

# Application News

## No. G293

### Gas Chromatograph

## Analysis of VOC in Water using Nexis GC-2030 and Headspace Sampler HS-10

Volatile Organic Compound (VOC) is a collective term used to describe organic compounds that can be easily vaporized. Some well known examples include: toluene, benzene, and dichloromethane. In recent years, amid mounting concerns over health and air pollution, strict regulations concerning the emission and examination of VOCs have been implemented.

This Application News describes the analysis of volatile organic compounds (VOCs) in water using Nexis GC-2030 equipped with ECD-2010 Exceed and headspace sampler HS-10.

K. Gregory, Y. Nagao

### ■ Instruments Used

**Table 1 Instruments**

|                   |                   |
|-------------------|-------------------|
| GC                | : Nexis GC-2030   |
| Headspace Sampler | : HS-10           |
| Detector          | : ECD-2010 Exceed |
| Software          | : LabSolutionsGC  |

\*Inert Liner 1.2 mm : P/N 221-76863-73



**Fig. 1 Nexis GC-2030 and HS-10**

### ■ Analytical Conditions

10 mL of mixed standard solution adjusted to 10 µg/L of each component and 3 g of sodium chloride were enclosed in a 20 mL volume headspace vial and measured under the following conditions.

**Table 2 Nexis GC-2030 Conditions**

|              |   |
|--------------|---|
| Column       | : SH-Rxi-624Sil MS (0.32 mm I.D. × 60 m, d.f. = 1.8 µm)                 |
| Column Temp. | : 40 °C (5 min) – 4 °C/min – 80 °C (0 min) – 10 °C/min – 250 °C (3 min) |
| Carrier Gas  | : He, 35 cm/sec (Constant Linear Velocity Mode)                         |
| Inj. Temp.   | : 170 °C  |
| Inj. Method  | : Split (1:10)  |
| Purge Flow   | : 3.0 mL/min  |
| Det. Temp.   | : 300 °C  |

**Table 3 HS-10 Conditions**

|                               |           |
|-------------------------------|-----------|
| Oven Temp.                    | : 60 °C   |
| Sample line Temp.             | : 150 °C  |
| Transfer line Temp.           | : 160 °C  |
| HSS Pressure                  | : 100 kPa |
| Vial shaking                  | : Level 3 |
| Vial shaking Time             | : 60 min  |
| Vial shaking equilibrium Time | : 0 min   |
| Vial heating Time             | : 0 min   |
| Vial pressurizing Time        | : 1.6 min |
| Pressurizing equilibrium Time | : 0.1 min |
| Loading Time                  | : 0.2 min |
| Loading equilibrium Time      | : 0.1 min |
| Injection Time                | : 1 min   |
| GC cycle Time                 | : 60 min  |

- |                               |                               |                          |
|-------------------------------|-------------------------------|--------------------------|
| 1: 1,1-Dichloroethylene       | 8: 1,2-Dichloroethane         | 15: Tetrachloroethylene  |
| 2: Dichloromethane            | 9: Trichloroethylene          | 16: Dibromochloromethane |
| 3: trans-1,2-Dichloroethylene | 10: 1,2-Dichloropropane       | 17: Bromoform            |
| 4: cis-1,2-Dichloroethylene   | 11: Bromodichloromethane      | 18: p-Dichlorobenzene    |
| 5: Chloroform                 | 12: cis-1,3-Dichloropropene   |                          |
| 6: 1,1,1-Trichloroethane      | 13: trans-1,3-Dichloropropene |                          |
| 7: Carbon tetrachloride       | 14: 1,1,2-Trichloroethane     |                          |

■ Results

Fig.1 shows the chromatogram of standard solution (each component 10 µg/L). Table 4 indicates repeatability of the peak area in five time continuous analysis. Good sensitivity and reproducibility were obtained.

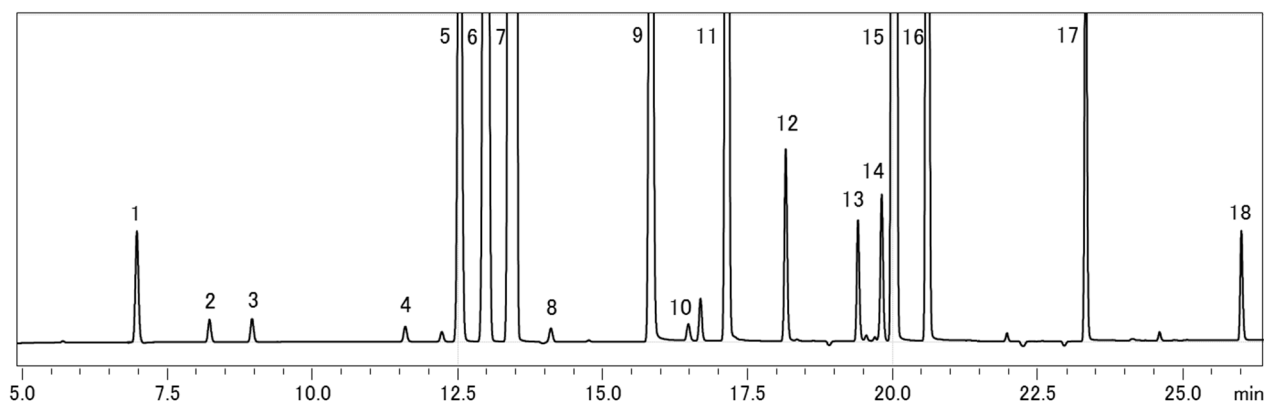


Fig. 2 Chromatogram of standard solution (each component 10 µg/L)

Table 4 Repeatability of the peak area of standard solution (n=5)

|                            | Area    | RSD(%) |
|----------------------------|---------|--------|
| 1,1Dichloroethylene        | 51868   | 1.27   |
| Dichloromethane            | 12379   | 1.74   |
| trans-1,2-Dichloroethylene | 11007   | 2.00   |
| cis-1,2-Dichloroethylene   | 7850    | 2.63   |
| Chloroform                 | 500926  | 1.56   |
| 1, 1, 1-Trichloroethane    | 1239853 | 1.35   |
| Carbon tetrachloride       | 2852152 | 1.27   |
| 1,2-Dichloroethane         | 7213    | 1.93   |
| Trichloroethylene          | 725831  | 1.54   |

|                           | Area    | RSD(%) |
|---------------------------|---------|--------|
| 1,1Dichloropropane        | 8633    | 2.21   |
| Bromodichloromethane      | 1315361 | 1.86   |
| cis-1,3-Dichloropropene   | 96110   | 2.19   |
| trans-1,3-Dichloropropene | 56857   | 2.34   |
| 1,1,2-Trichloroethane     | 75434   | 1.81   |
| Tetrachloroethylene       | 2135446 | 1.59   |
| Dibromochloromethane      | 701019  | 2.01   |
| Bromoform                 | 205394  | 1.88   |
| p-Dichlorobenzene         | 53132   | 1.81   |

Note: The above stated values are reference values only. Values may vary depending on the environment and analytical procedure.



## Shimadzu Guide to BFB Tuning for Analysis of Volatile Organic Compounds

### ■ Introduction

All US EPA methods for volatile organic compounds (VOCs) require that specific GCMS tuning criteria be met before running a calibration curve or analyzing actual samples. The GCMS is tuned using the traditional tuning compound, PFTBA (perfluorotributylamine), and the tune is evaluated every 12 hours by injecting BFB (4-bromofluorobenzene) and measuring the relative intensity of key mass fragments. The MS tuning procedures adjust PFTBA ion responses to achieve the desired BFB response ratios. The relative ion abundance of the BFB mass fragments must meet specific criteria established in the methods to ensure that the GCMS instrument operating conditions are adjusted and optimized for analysis of VOCs, and the criteria must be met every 12 hours to guarantee that the instrument performance remains stable enough for continued analysis.

Because of the importance of GCMS in environmental analyses, it is essential to standardize the EI spectra to minimize variability between operators and across different instrument platforms. Standardization ensures that spectra of the same compound, measured by different operators on different instruments under similar conditions, will reliably produce the same results<sup>i</sup>. The tuning criteria given in US EPA methods assures that the relative abundance criteria produced by GCMS is repeatable across all instrument platforms and laboratories, and minimize variances when different laboratories analyze the same samples<sup>ii,iii</sup>.

This application note describes tuning conditions for the Shimadzu GCMS-QP2010 SE (Figure 1) developed to meet the BFB relative abundance criteria described in US EPA methods for analysis of VOCs. Results of an extensive evaluation of the instrument stability using the recommended tune conditions, and a description of the various tune parameter settings are included.



Figure 1 Shimadzu GCMS-QP2010 SE

### ■ Tuning Criteria

The BFB tuning criteria for the most common US EPA VOC methods are very similar, although there are a few notable differences. Table 1 compares the BFB Relative Abundance Criteria for five different US EPA VOC methods. Method 524.3<sup>iv</sup> is much less strict than the others, completely eliminating the mass abundance criteria for  $m/z$  50 and 75, and broadening the acceptance ranges for  $m/z$  176 and 177. The tune criteria for US EPA Methods 624<sup>v</sup> and 8260C<sup>vi</sup> are identical to one another, and are the most exacting among the five methods for all nine criteria. Meeting the relative abundance criteria for either of these two methods, will ensure that the instrument will meet criteria for all VOC methods.

**Table 1:** Comparison of BFB Relative Abundance Criteria for US EPA VOC Methods

| Mass (m/z) | Relative Abundance Criteria |                      |                     |                     |                   |
|------------|-----------------------------|----------------------|---------------------|---------------------|-------------------|
|            | Method 524.2                | Method 524.3         | Method 624          | Method 8260C        | CLP-SOW           |
| 50         | 15 to 40% of 95             | NA                   | 15 to 40% of 95     | 15 to 40% of 95     | 15 to 40% of 95   |
| 75         | 30 to 80% of 95             | NA                   | 30 to 60% of 95     | 30 to 60% of 95     | 30 to 80% of 95   |
| 95         | Base Peak, 100%             | Base Peak, 100%      | Base Peak, 100%     | Base Peak, 100%     | Base Peak, 100%   |
| 96         | 5 to 9% of 95               | 5 to 9% of 95        | 5 to 9% of 95       | 5 to 9% of 95       | 5 to 9% of 95     |
| 173        | <2% of 174                  | <2% of 174           | <2% of 174          | <2% of 174          | <2% of 174        |
| 174        | >50% of 95                  | >50% of 95           | >50% of 95          | >50% of 95          | 50 to 120% of 95  |
| 175        | 5 to 9% of 174              | 5 to 9% of 174       | 5 to 9% of 174      | 5 to 9% of 174      | 4 to 9% of 174    |
| 176        | >95 to <101% of 174         | >95 to < 105% of 174 | >95 to <101% of 174 | >95 to <101% of 174 | 95 to 101% of 174 |
| 177        | 5 to 9% of 176              | 5 to 10% of 176      | 5 to 9% of 176      | 5 to 9% of 176      | 5 to 9% of 176    |

■ **Experimental**

*GCMS Conditions*

There are many factors that can affect the instrument’s ability to meet the specified criteria, including cleanliness of the ion source, GC oven temperature and column flow rate, threshold setting, and the tuning parameters themselves. Table 2 summarizes the GC and MS operating conditions used for instrument tuning, and during the BFB tune

evaluation. During instrument tuning with PFTBA, the oven temperature was held constant at 180 °C, to match the oven temperature at which the BFB elutes from the GC column; during BFB tune evaluation a ramped oven temperature program was used. Otherwise, all conditions were as shown in the table.

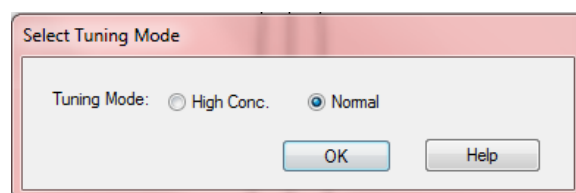
**Table 2:** GCMS Operating Conditions during Tune and BFB Tune Evaluation

|                          |  |
|--------------------------|--|
| <b>Gas Chromatograph</b> | <b>GC-2010 Plus</b>  |
| Injection Port           | 200 °C, split mode, 40:1 split ratio   |
| Column                   | SH-Rxi-624Sil MS, 30 m x 0.25 mm x 1.4 µm (Shimadzu PN 221-75962-30)<br>He carrier gas<br>Constant Linear Velocity, 36 cm/second |
| Oven Temperature         | TUNE: Isothermal at 180 °C<br>ANALYSIS: 45 °C (1.0 minute), 15 °C/minute to 220 °C (3.5 minutes)                                 |
| <b>Mass Spectrometer</b> | <b>GCMS-QP2010 SE</b>  |
| Interface Temperature    | 180 °C   |
| Ion source Temperature   | 185 °C   |
| Detector Voltage         | Relative to Tune + 0.1 kV  |
| Threshold                | 100  |
| Scan Range               | m/z 35 to 265<br>Event time 0.25 seconds   |

*Tune Conditions*

Each time the instrument was tuned, the tune conditions were initialized using the following commands from GCMSsolutions Real Time Analysis module: Tuning > File > New Tuning File > Select Tuning Mode > Normal (Figure 2). Initializing the conditions ensures that the tune file is always initiated from the original factory default settings prior to tuning, and does not overwrite any existing tune files. Using the “Normal” tuning mode sets the ion energy to 70 eV, and the emission current to 60

µA for optimum sensitivity, while extending the lifetime of the filament.



**Figure 2:** Default Tune Mode

The factory default tune settings are designed to provide a generalized tune which can be used for a variety of applications. The default tune algorithm adjusts source and lens voltages so that PFTBA ion abundances meet predetermined target abundances, and optimize sensitivity across a wide mass range (Figure 3A).

When tuning for VOC methods, the tune conditions are modified to change the PFTBA target abundances so a subsequent analysis of BFB will meet the relative abundance criteria established in the methods. Figure 3B shows the modified tune conditions recommended for BFB tuning on the Shimadzu GCMS-QP2010 SE.

The Target Mass for the sensitivity adjustment has been changed from  $m/z$  264 to  $m/z$  69 to optimize

sensitivity for the lower mass range used in VOC methods, and the Mass Pattern Intensity Ratios have been adjusted to meet BFB relative abundance criteria. The Intensity Ratio values shown here will work for most cases, but can be adjusted slightly, up or down, as needed to continue to meet the BFB criteria as the instrument ages.

Figure 4 shows a tune report from the GCMS-QP2010 SE that includes the target abundances defined in the Tune Conditions, and the actual abundances achieved during the tune process. These conditions were found to produce a tune that met the strict BFB relative abundance criteria for all VOC methods on multiple instruments, and remained stable over the evaluation period of approximately 3 months.

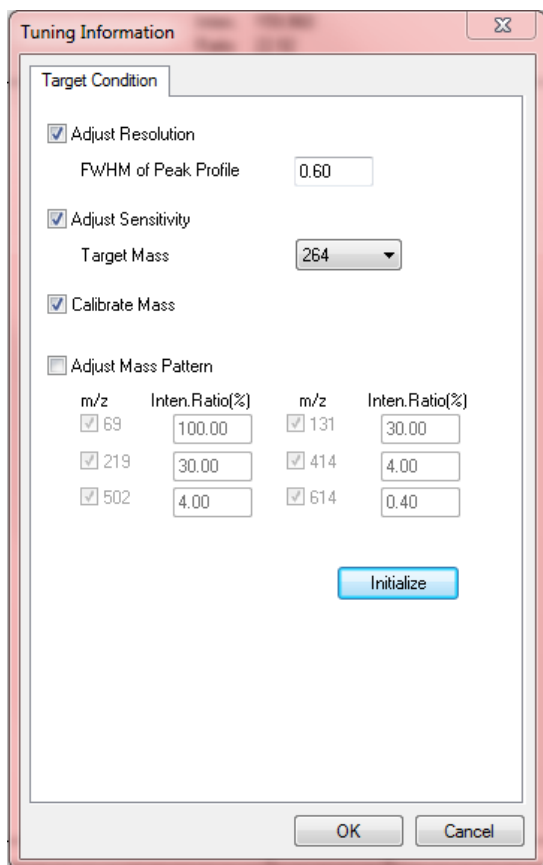


Figure 3A: General Purpose Default Tune Conditions

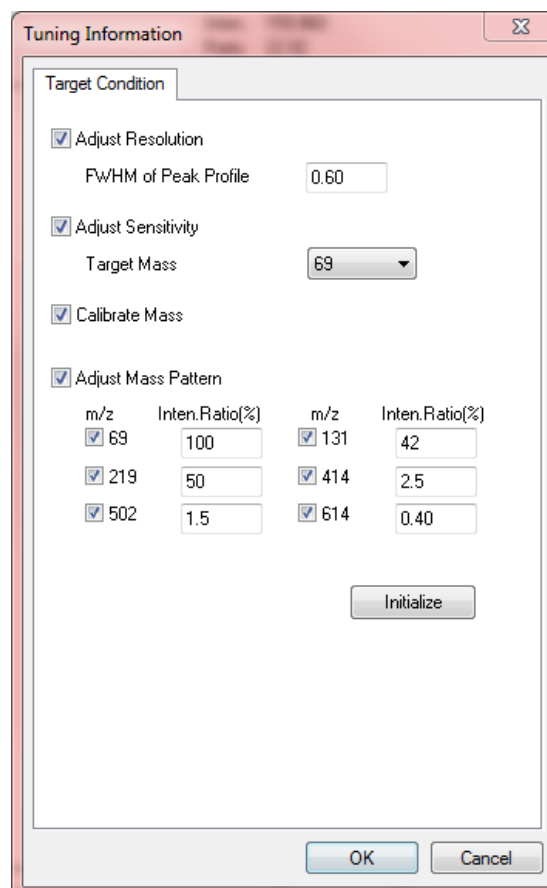
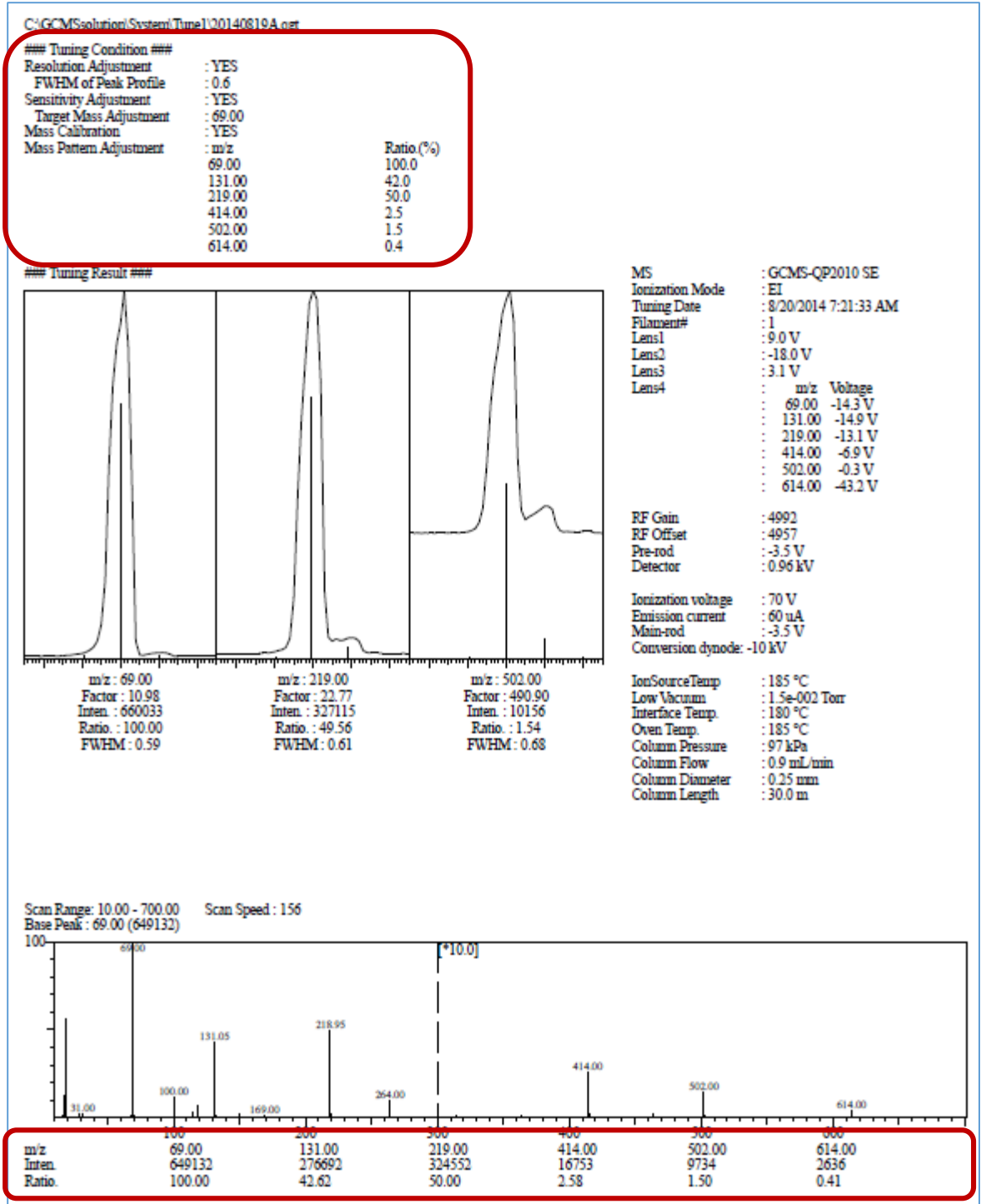


Figure 3B: Recommended BFB Tune Conditions Using  $m/z$  69 as the Target Mass and Mass Pattern Adjustment



Target Abundance and Actual Abundance from a Typical Tune Report Using the Recommended Conditions

| Target Mass           | 69   | 131    | 219 | 414   | 502  | 614   |
|-----------------------|------|--------|-----|-------|------|-------|
| Target Abundance      | 100% | 42%    | 50% | 2.5%  | 1.5% | 0.40% |
| Actual Tune Abundance | 100% | 42.62% | 50% | 2.58% | 1.5% | 0.41% |

Figure 4: Typical Tune Report from a Shimadzu GCMS-QP2010 SE Using Recommended Tune Conditions

*Bake Out*

Each day before starting a sample sequence, the instrument was conditioned by cycling the P&T and VOCARB 3000 trap through two Bake cycles. Simultaneously, the oven, injection port, ion source, and MS interface temperatures were all raised to 220 °C for a minimum of one hour. The instrument bake-out procedure was run on all days, whether samples were analyzed or not.

*Interruptions*

During the 3-month evaluation period, the laboratory experienced multiple incidents of power failure or depletion of the He carrier gas which interrupted operation. In virtually all cases, the tune parameters, retention times, and calibration remained constant and did not have to be re-run.

■ **Results and Discussion**

*Tune Results*

Figure 5 shows a typical chromatogram, spectrum, and results for a BFB tune evaluation from a single analysis of 4-bromofluorobenzene. All BFB tune

evaluations were done by purging the BFB and desorbing to the GC, rather than by manual syringe injection.

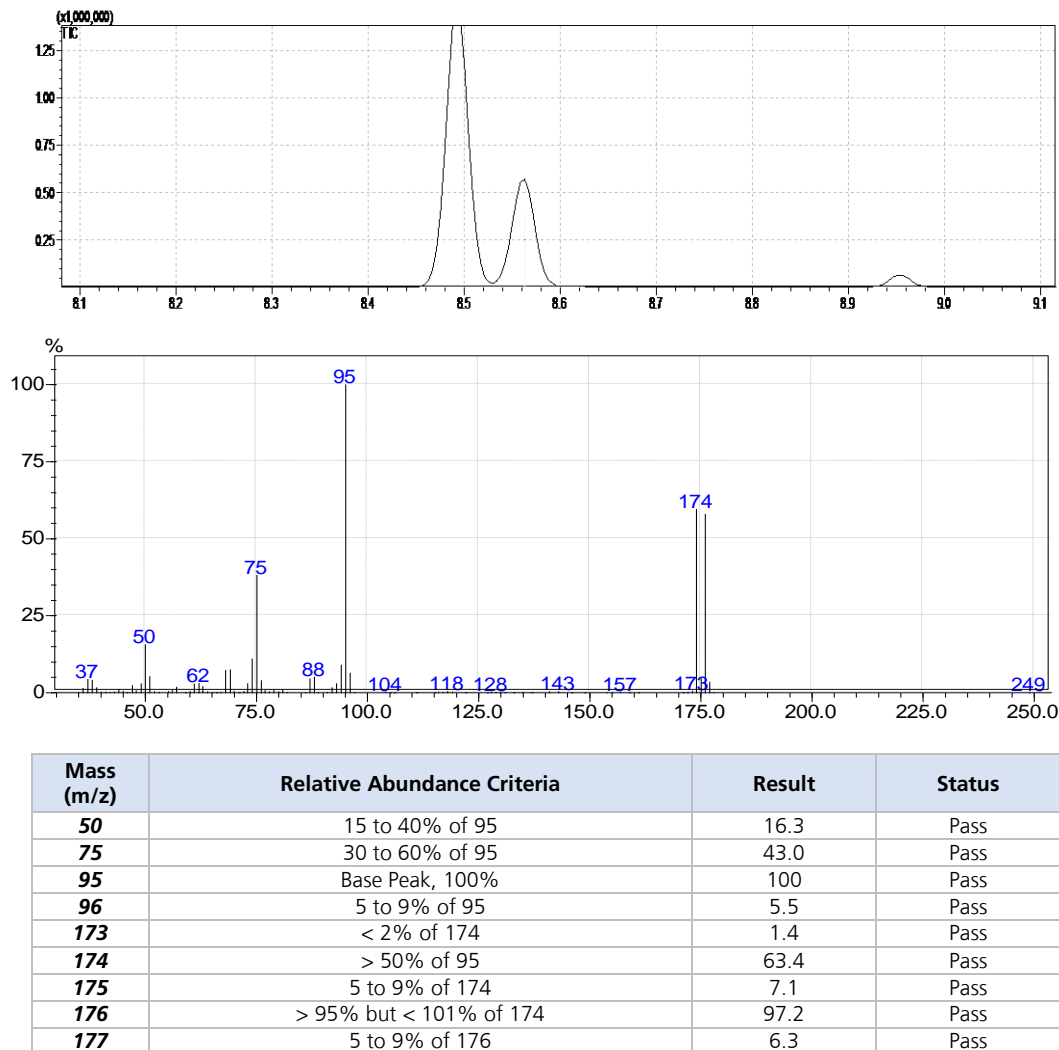


Figure 5: Typical Results from BFB Tune Evaluation Using US EPA Method 624 Criteria

### Stage One

The current study was done in two stages. The first stage was a detailed analysis of the individual GCMS and instrument tune parameters, to find the optimized tune conditions that would consistently meet the BFB relative abundance criteria and produce reliable, stable results. This stage covered a 7-week period, during which 16 individual sequences were run assessing a variety of different instrument and tune variables; each sequence included between 30 and 40 discrete analyses. The Internal (IS) and

Surrogate Standards (SS) from US EPA Method 524.2, including BFB, were used for the analyses, and for each sequence the area counts for the IS and SS were monitored to evaluate stability. Even sequences using tuning variables that did not produce reliable BFB tune evaluations, did provide stable IS and SS response throughout the sequence. The stability of the instrument over this period is summarized in Table 3.

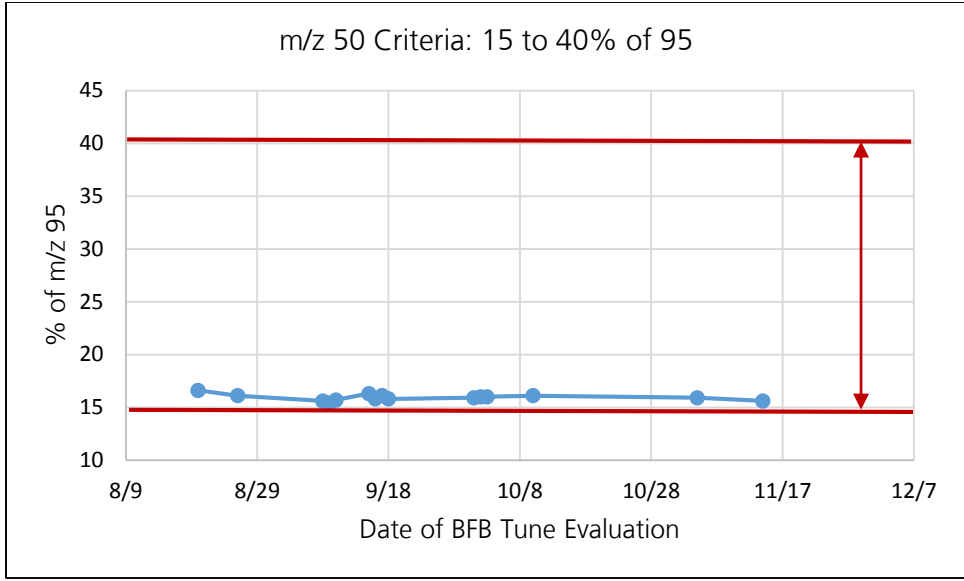
**Table 3:** Summary of Method 524.2 IS and SS Stability, Run as 16 Sequences Over 7 Weeks during Stage One of the Study

| Summary of Method 524.2 Stability Results |                       |                    |                      |                      |
|---|-----------------------|--------------------|----------------------|----------------------|
| Sequence Number                           | Sequence Details      | IS Area Count %RSD | SS#1 Area Count %RSD | SS#2 Area Count %RSD |
| 1   | Run 7/28/2014, n = 32 | 2.9%               | 2.5%                 | 2.8%                 |
| 2   | Run 7/30/2014, n = 35 | 6.5%               | 4.1%                 | 4.6%                 |
| 3   | Run 7/31/2014, n = 33 | 3.9%               | 3.0%                 | 4.4%                 |
| 4   | Run 8/8/2014, n = 34  | 2.4%               | 2.9%                 | 3.0%                 |
| 5   | Run 8/11/2014, n = 32 | 4.0%               | 2.1%                 | 1.9%                 |
| 6   | Run 8/12/2014, n = 35 | 2.1%               | 2.6%                 | 2.6%                 |
| 7   | Run 8/14/2014, n = 30 | 5.3%               | 9.4%                 | 5.2%                 |
| 8   | Run 8/15/2014, n = 30 | 3.3%               | 5.4%                 | 5.1%                 |
| 9   | Run 8/18/2014, n = 33 | 2.2%               | 3.2%                 | 1.9%                 |
| 10  | Run 8/19/2014, n = 35 | 3.9%               | 5.7%                 | 4.4%                 |
| 11  | Run 8/20/2014, n = 40 | 5.4%               | 7.6%                 | 6.8%                 |
| 12  | Run 8/22/2014, n = 33 | 1.8%               | 4.1%                 | 2.8%                 |
| 13  | Run 9/2/2014, n = 34  | 5.3%               | 4.2%                 | 4.6%                 |
| 14  | Run 9/3/2014, n = 35  | 8.5%               | 8.1%                 | 4.3%                 |
| 15  | Run 9/4/2014, n = 31  | 5.3%               | 8.0%                 | 5.3%                 |
| 16  | Run 9/8/2014, n = 15  | 1.9%               | 3.3%                 | 3.3%                 |
| <i>IS = Fluorobenzene</i>                 |                       |                    |                      |                      |
| <i>SS#1 = 4-Bromofluorobenzene</i>        |                       |                    |                      |                      |
| <i>SS#2 = 1,2-Dichlorobenzene-d4</i>      |                       |                    |                      |                      |

### Stage Two

At the beginning of the second stage of the project, the instrument was tuned using the recommended optimized conditions shown in Table 2 and Figure 3B. Using a single tune file over approximately 2½ months, multiple sequences were run to evaluate BFB performance and IS and SS stability, followed by a complete validation study for US EPA Method 624. As required by the method, at the beginning of each 12-hour period an aliquot of BFB was purged and

analyzed, and the relative abundance of mass peaks were evaluated against the criteria set out in the method. The 12-hour BFB tune evaluation samples passed all method criteria in virtually every case over the 2½ month period, using a single tune file. The instrument did not require re-tuning during the evaluation period. The BFB relative abundance criteria for 15 sequences over 2½ months are shown in Figure 6.



**Figure 6:** Evaluation of BFB Tune Criteria for 15 Sequences Run Over a 2½ Month Period. The Instrument Did Not Require Re-Tuning, and the Same Tune File Was Used During the Entire Period.

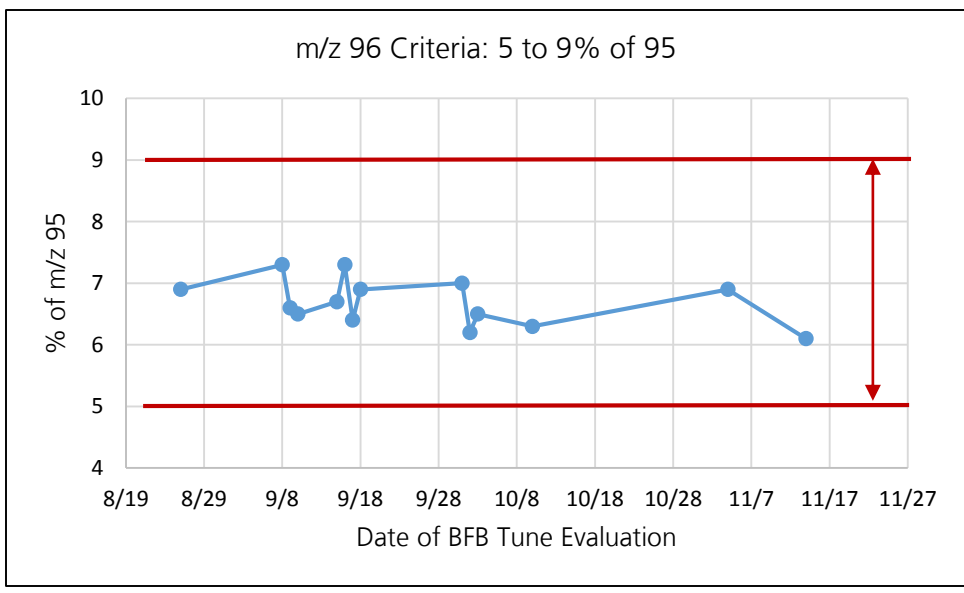
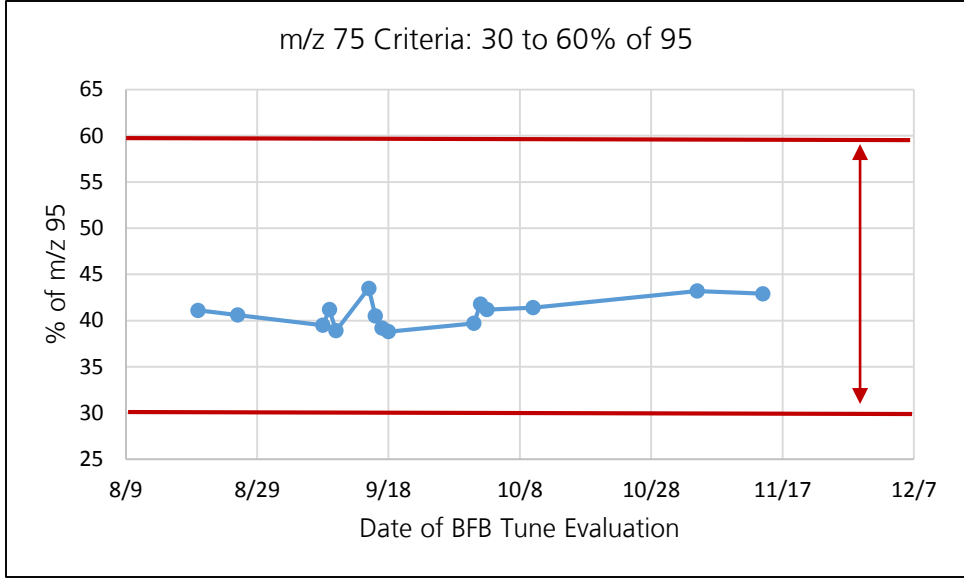
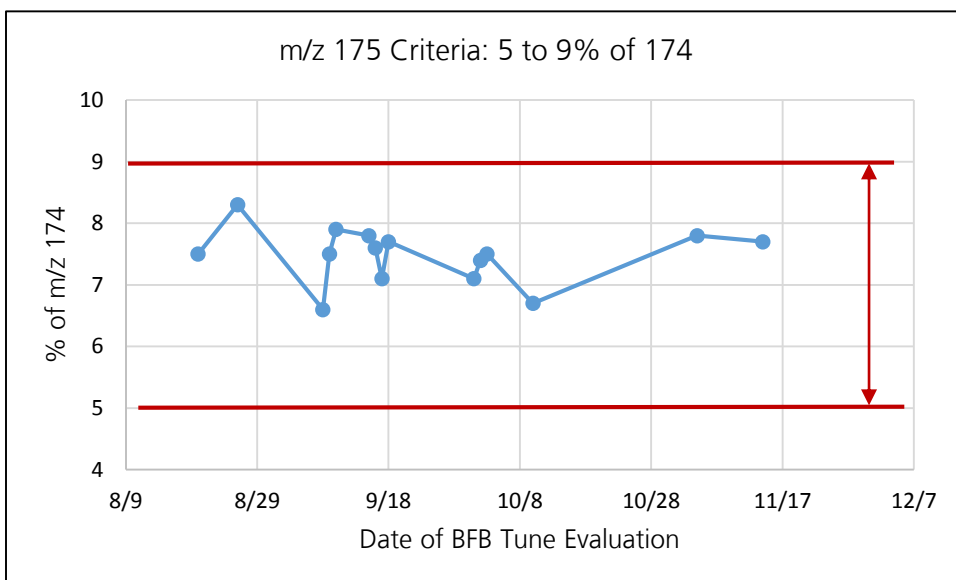
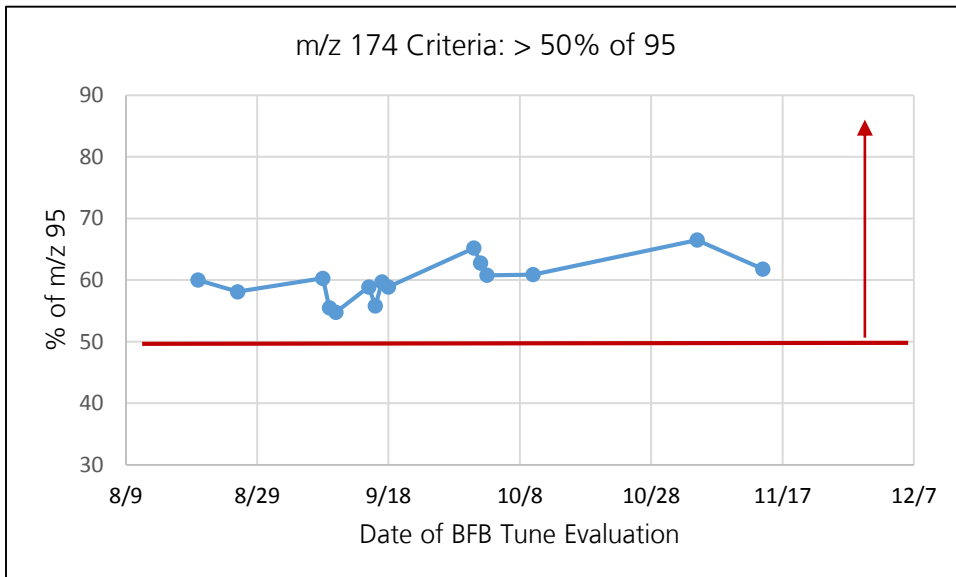
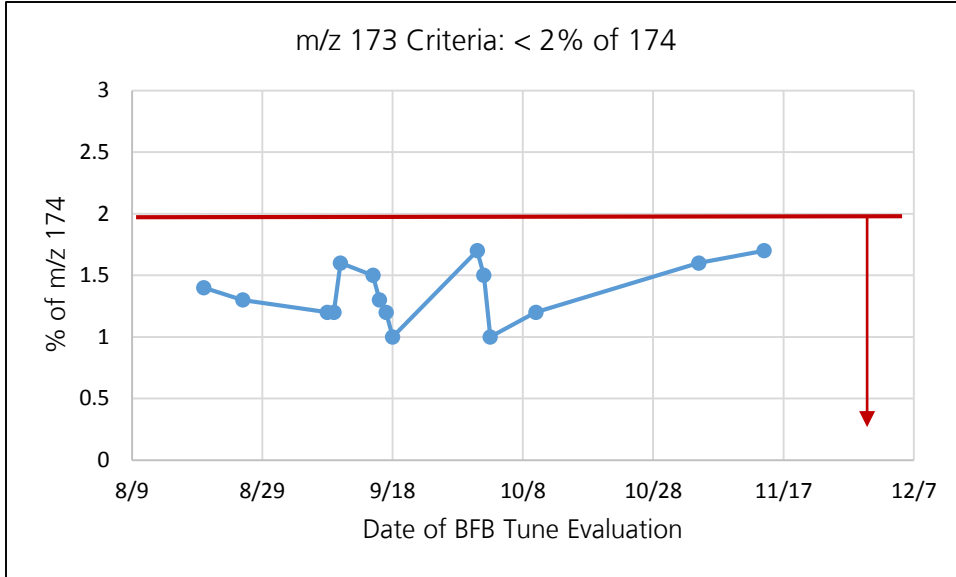


Figure 6: continued





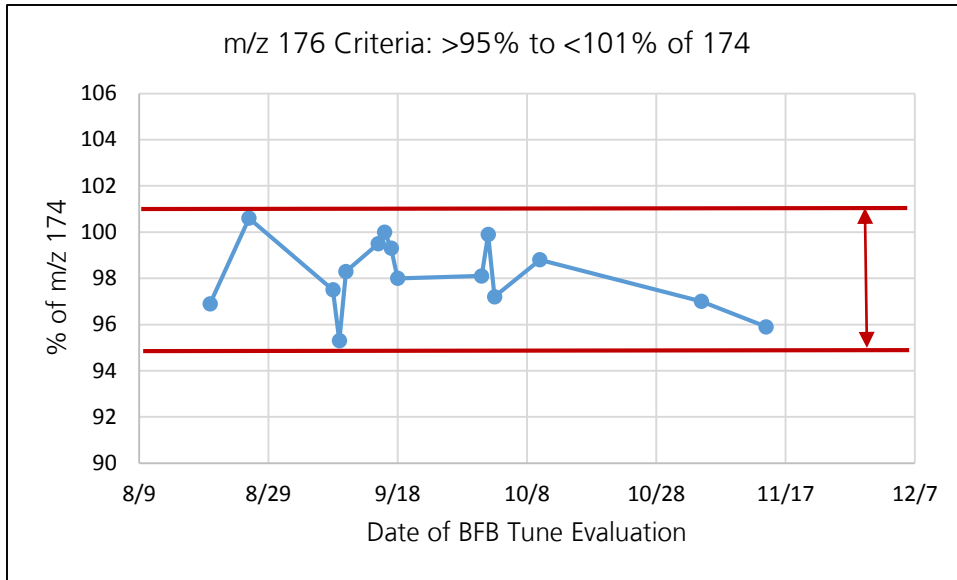


Figure 6: continued

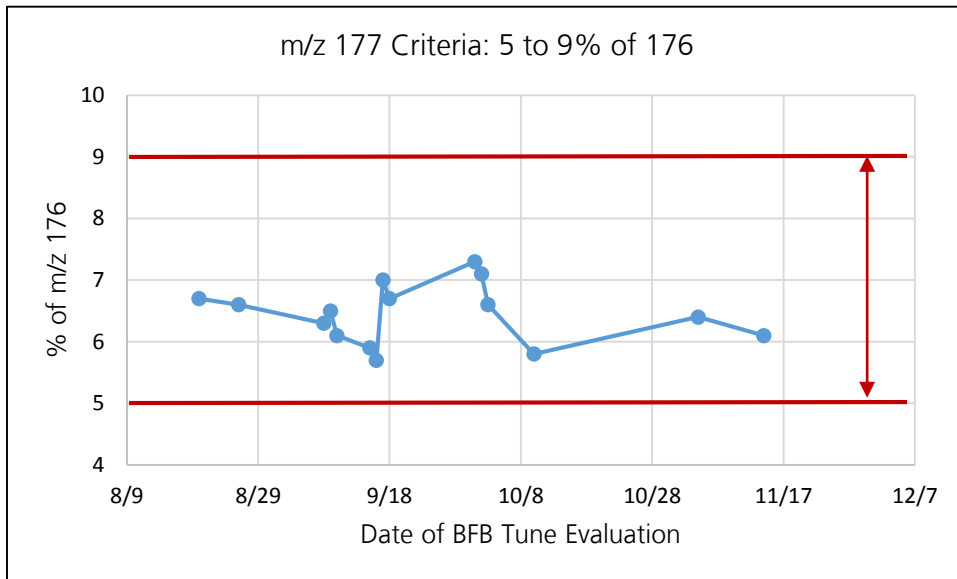


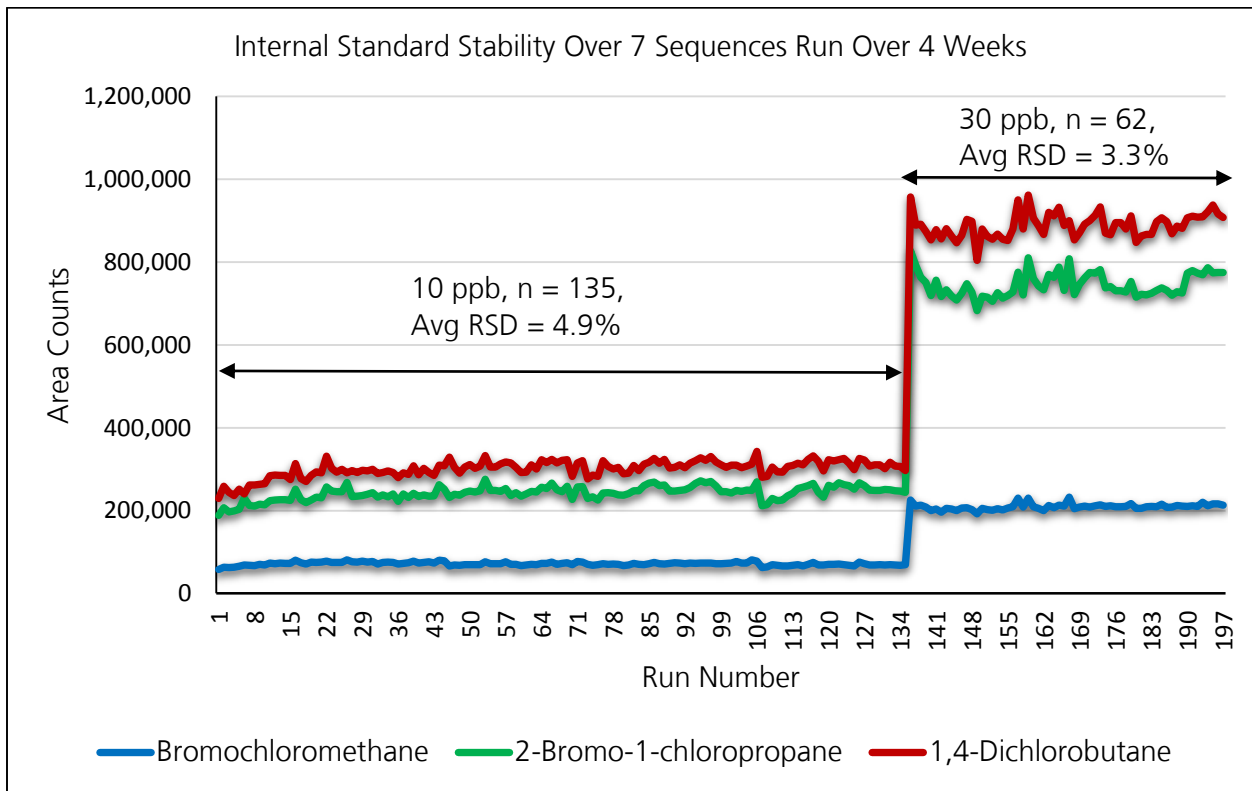
Figure 6: continued

Seven of the sequences were run over a period of four weeks to complete a validation study for US EPA Method 624<sup>vi</sup>. Each sequence was comprised of 21 to 32 individual sample analyses. The IS and SS

stability was measured as %RSD of peak area counts for each sequence, and are summarized in Table 4. The IS area counts for all 197 analyses are plotted in Figure 7.

**Table 4:** Summary of Method 624 IS and SS Stability, Run as 7 Sequences Over 4 Weeks during Stage Two of the Study

| Summary of Method 624 Stability Results |                                       |                      |                      |                                    |                      |                      |                      |
|---|---------------------------------------|----------------------|----------------------|------------------------------------|----------------------|----------------------|----------------------|
| Sequence Number                         | Sequence Details                      | IS#1 Area Count %RSD | IS#2 Area Count %RSD | IS#3 Area Count %RSD               | SS#1 Area Count %RSD | SS#2 Area Count %RSD | SS#3 Area Count %RSD |
| 1                                       | Run 9/9/2014, n = 21<br>IS at 10 ppb  | 7.6%                 | 6.6%                 | 7.9%                               | 8.3%                 | 3.7%                 | 3.6%                 |
| 2                                       | Run 9/10/2014, n = 24<br>IS at 10 ppb | 3.4%                 | 4.3%                 | 3.6%                               | 5.2%                 | 6.9%                 | 2.8%                 |
| 3                                       | Run 9/15/2014, n = 30<br>IS at 10 ppb | 4.1%                 | 4.6%                 | 4.7%                               | 9.3%                 | 5.6%                 | 4.9%                 |
| 4                                       | Run 9/16/2014, n = 30<br>IS at 10 ppb | 3.5%                 | 4.1%                 | 3.3%                               | 4.5%                 | 2.9%                 | 3.1%                 |
| 5                                       | Run 9/17/2014, n = 30<br>IS at 10 ppb | 4.5%                 | 6.2%                 | 4.6%                               | 4.4%                 | 4.1%                 | 5.2%                 |
| 6                                       | Run 10/2/2014, n = 30<br>IS at 30 ppb | 4.2%                 | 4.5%                 | 4.0%                               | 5.1%                 | 4.3%                 | 3.5%                 |
| 7                                       | Run 10/3/2014, n = 32<br>IS at 30 ppb | 1.7%                 | 3.2%                 | 2.6%                               | 2.0%                 | 2.0%                 | 1.9%                 |
| <i>IS#1 = Bromochloromethane</i>        |                                       |                      |                      | <i>SS#1 = Pentafluorobenzene</i>   |                      |                      |                      |
| <i>IS#2 = 2-Bromo-1-chloropropane</i>   |                                       |                      |                      | <i>SS#2 = Fluorobenzene</i>        |                      |                      |                      |
| <i>IS#3 = 1,4-Dichlorobutane</i>        |                                       |                      |                      | <i>SS#3 = 4-Bromofluorobenzene</i> |                      |                      |                      |



**Figure 7:** US EPA Method 624 Internal Standard Stability for 7 Sequences (197 Analyses) Run Over 4 Weeks

### ■ Terminology

The following section provides a brief description of some of the parameter settings that are used for GCMS tuning. For a complete description, see the Help menu in GCMSsolutions.

#### *Adjust Resolution*

The adjustment is performed so that the mass spectral peak width at half-height, acquired by measuring target  $m/z$  fragments for PFTBA, approaches that of the set point. For normal scanning, a value for FWHM (Full Width at Half Maximum) between 0.5 and 0.7 is considered optimal; this is sometimes called Unit Resolution on a single quadrupole MS. The smaller the width at half-height, the better will be the mass spectral resolution; however the sensitivity will tend to decrease with increasing resolution.

#### *Adjust Sensitivity, Target Mass*

The lens voltages are adjusted so that the intensity of the specified Target Mass (e.g.  $m/z$  264 or 69) is optimized. For general applications requiring equal sensitivity across a wide mass range,  $m/z$  264 is used as the Target Mass. For VOC methods, which scan over a narrow mass range and cover only very low masses (i.e.  $m/z$  35 to 265), a Target Mass of  $m/z$  69 is selected to optimize the MS sensitivity over the narrower, lower mass range.

#### *Adjust Mass Pattern*

The lens voltages are adjusted so that the intensity ratio of the target fragments ( $m/z$  69, 131, 219, 414, 502, and 614) match the defined set points during scan. The defined set points and actual abundances achieved during tune can be read from the Tune Report.

#### *Electron Energy*

Energy of the electrons produced by the filament, and controlled by the potential difference between the filament and the source block. The ionization efficiency and fragmentation pattern depend on the energy of the electrons, with higher energies producing greater fragmentation. Most quadrupole MS instruments use 70 eV because it produces consistent, reproducible mass spectral fragmentation patterns for organic molecules, and because most reference spectra used for library matching are acquired at that energy.







### ■ Summary and Conclusions

The recommended tune conditions shown here easily meet all BFB Tune Evaluation criteria defined in all US EPA methods for analysis of Volatile Organic Compounds by GCMS. A single tune file produced BFB data that met the criteria for all sequences run over at least three months. During the evaluation period, a validation study for US EPA Method 624 met all defined method criteria, producing stable IS and SS peak areas and passing BFB Tune Evaluations. The instrument did not require re-tuning at any time during the validation study.

Using the Shimadzu GCMS-QP2010 SE and the tune conditions described here should produce reliable instrument performance and passing BFB Tune Evaluations over an extended period of time.

### ■ Ordering Information for Replacement Consumables

The consumables used in this application note are shown in the table below. To order any of these items please contact Customer Service at Shimadzu Scientific Instruments at 1-800-477-1227, or visit our web store at <http://store.shimadzu.com>.

| Part Number  | Item Name                | Photo   | Item Description  |
|--------------|--------------------------|---|---|
| 221-75962-30 | Capillary Column         |    | SH-RXI-624 SIL MS, 30 m x 0.25 mm x 1.40 µm   |
| 220-90784-10 | Inlet Liner              |    | Low-volume Liner, 1.0 mm ID, Straight, 5/Pkg (Restek)   |
| 220-94775-10 | VOA Tuning Compound      |    | 1-Bromo-4-fluorobenzene (BFB), 5,000 µg/mL in P&T MeOH, 1 mL/ampule, CAS #: 460-00-4 (Restek) |
| 220-94775-00 | n-Alkane Mix             |    | AART Standard for determination of Retention Index (RI) and Retention Times (RT)              |
| 220-94594-00 | Electronic Flow Meter    |   | ProFLOW 6000 Electronic Flow Meter (Restek)   |
| 220-94594-01 | Electronic Leak Detector |  | Electronic Leak Detector With Hard-Sided Carrying Case and Universal Charger Set (Restek)     |

### ■ References

- I. Eichelberger, J.W., Harris, L.E., Budde W.L., Anal Chem 1975, 47, pages 995-1000.
- II. Ballinger, D.G., Environ. Sci. Technology, 1979, 13, pages 1362-1366.
- III. Budde, W.L., Analytical Mass Spectrometry, Strategies for Environmental and Related Applications, Oxford University Press, 2001 page 114.
- IV. Method 524.3, Measurement of Purgeable Organic Compounds in Water by Capillary Column Gas Chromatography/Mass Spectrometry, Version 1.0 June 2009, EPA Document #EPA 815-B-09-009.
- V. Appendix A to Part 136, Methods for Organic Chemical Analysis of Municipal and Industrial Wastewater, Method 624 – Purgeables.
- VI. Method 8260C, Volatile Organic Compounds by Gas Chromatography/Mass Spectrometry (GC/MS), Revision 3, August 2006.
- VII. Shimadzu Guide to US EPA Method 624 for Analysis of Volatile Organic Compounds in Wastewater, GCMS Application News No. GCMS-1406.

First Edition: November 2014



SHIMADZU Corporation  
[www.shimadzu.com/an/](http://www.shimadzu.com/an/)

SHIMADZU SCIENTIFIC INSTRUMENTS  
7102 Riverwood Drive, Columbia, MD 21046, USA  
Phone: 800-477-1227/410-381-1227, Fax: 410-381-1222  
URL: [www.ssi.shimadzu.com](http://www.ssi.shimadzu.com)

For Research Use Only. Not for use in diagnostic procedures.  
The contents of this publication are provided to you "as is" without warranty of any kind, and are subject to change without notice.  
Shimadzu does not assume any responsibility or liability for any damage, whether direct or indirect, relating to the use of this publication.

### Shimadzu Guide to US EPA Methods 524.3 and 524.4 for Analysis of Volatile Organic Compounds in Drinking Water

No. GCMS-1502

Anne Jurek, EST Analytical

#### ■ Abstract

Due to advances in analytical instrumentation the United States Environmental Protection Agency (US EPA) introduced a new drinking water method in June 2009. US EPA Method 524.3<sup>1</sup> allows laboratories to modify purge and trap and GCMS conditions in order to accommodate instrumental advances and shorten sample preparation time. The US EPA also investigated the option of using nitrogen as the purge gas in an additional drinking water method, US EPA Method 524.4<sup>2</sup>. This application note will compare analytical results when using helium and nitrogen purge gases.

#### ■ Introduction

US EPA Method 524.3 allowed the ability to modify purge and trap parameters and take advantage of purge and trap improvements. However, the method still required helium for the purge gas. Since then, high-purity helium availability and price has changed making it harder to find and more expensive to buy. Due to this change in the helium market, the US EPA drafted Method 524.4, which allows the use of high-purity nitrogen for the purge gas.

Method 524.4 provides the same flexibility as Method 524.3, thus method parameters can be modified in order to optimize purge and trap cycle times. Although the new method allows for a shorter desorb time, moisture build up can still be a problem as the new preservation scheme causes effervescing in the sparge vessel. EST Analytical has two features that can aid in moisture control and the “foaming” caused by the effervescing. First, the

Encon Evolution utilizes an 8-port valve instead of a 6-port valve. This unique engineering feature has the advantage of excluding the Moisture Reduction Trap (MoRT) from the desorb pathway during the desorb step, thus aiding in moisture control for the system. Secondly, EST Analytical has a foam sensor to detect any foaming. The foam sensor for the Encon Evolution has a unique placement above the bulb of the sparge vessel, thus allowing the bulb to control the effervescing bubbles and not sending a false positive signal to the software causing the sample sequence to be aborted. Furthermore, the Centurion WS (Water Soil) autosampler has the ability to remove samples from the vials without moving the vials. This eliminates opportunities for vial-movement errors that would negatively impact productivity.

For this study, helium and nitrogen purge gases were compared utilizing the same purge flow rate. Results from the linearity, precision, accuracy and overall compound response are compared for the two different purge gases.

#### ■ Experimental

##### *Instrumentation*

The EST Analytical Encon Evolution purge and trap concentrator and Centurion WS autosampler were interfaced to a Shimadzu GCMS-QP2010 SE (Figure 1). The purge and trap concentrator was configured with a Vocabarb 3000 (K) analytical trap. As required by the methods, a chiller unit capable of keeping the sample vials cooled below 10 °C was installed on the Centurion WS autosampler. The experimental parameters are listed in Tables 1 and 2.



Figure 1: Shimadzu GCMS-QP2010 SE



EST Analytical Encon Evolution purge and trap concentrator and Centurion WS autosampler

**Table 1:** Purge and Trap Parameters

| <b>Purge and Trap Concentrator</b>              | <b>EST Encon Evolution</b> |
|---|----------------------------|
| Trap Type                                       | Vocarb 3000 (K Trap)       |
| Valve Oven Temperature                          | 150 °C                     |
| Transfer Line Temperature                       | 150 °C                     |
| Trap Temperature                                | 35 °C                      |
| Moisture Reduction Trap (MoRT) Temperature      | 39 °C                      |
| Purge Time                                      | 11 minutes                 |
| Purge Flow Rate                                 | 40 mL/minute               |
| Dry Purge Temperature                           | Ambient                    |
| Dry Purge Flow Rate                             | 50 mL/minute               |
| Dry Purge Time                                  | 1 minute                   |
| Desorb Pressure Control                         | On                         |
| Desorb Pressure Control                         | 5 psi                      |
| Desorb Preheat Delay                            | 5 seconds                  |
| Desorb Time                                     | 1 minute                   |
| Desorb Temperature                              | 260 °C                     |
| Moisture Reduction Trap (MoRT) Bake Temperature | 230 °C                     |
| Bake Temperature                                | 265 °C                     |
| Sparge Vessel Bake Temperature                  | 120 °C                     |
| Bake Time                                       | 8 minutes                  |
| Bake Flow                                       | 40 mL/minute               |
| <b>Purge and Trap Autosampler</b>               | <b>EST Centurion WS</b>    |
| Sample Size                                     | 5 mL                       |
| Internal Standard Volume                        | 5 µL                       |
| Surrogate Volume                                | 5 µL                       |

**Table 2:** GC/MS Parameters

| <b>GC/MS</b>             | <b>GCMS-QP2010 SE</b>   |
|--------------------------|---|
| Injection Mode           | Split   |
| Injection Temperature    | 200 °C  |
| Flow Control mode        | Constant Linear Velocity  |
| Linear Velocity          | 34.3 cm/second  |
| Column Flow Rate         | 0.9 mL/minute   |
| Split Ratio              | 30:1  |
| Purge Flow               | 1.0 mL/minute   |
| Column                   | Rxi-624Sil MS 30 m x 0.25 mm I.D. 1.4 µm film thickness   |
| Oven Temperature Program | 45 °C, hold for 4.5 minutes<br>12 °C/minute to 100 °C, hold for 0.0 minute<br>25 °C/minute to 240 °C, hold for 1.32 minutes |
| Ion Source Temperature   | 185 °C  |
| Interface Temperature    | 225 °C  |
| Solvent Cut Time         | 0.0 minute  |
| Scan Range               | 35-300 m/z  |
| Event Time               | 0.30 second   |

### Study Design

The GC column and standards were acquired from Restek. The linear range for both purge gases was established with a seven-point quadratic regression calibration from 0.5 ppb to 40 ppb. The internal standard and surrogate concentrations were held constant at 5 ppb. Figure 2 displays an overlay of the

Total Ion Chromatograms (TIC) of the 20 ppb standard purged in helium (blue) and nitrogen (orange). Using the analytical conditions described in Tables 1 and 2, purge efficiency was nearly identical for the two gases, with helium providing slightly better purge efficiency for a few select compounds.

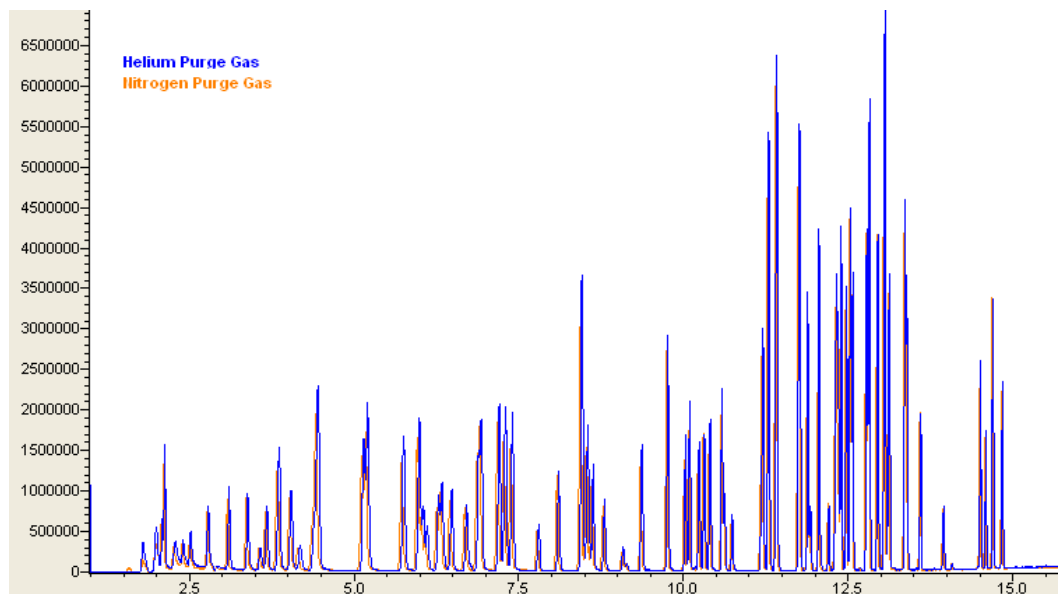


Figure 2: Overlay of 20ppb Standards Purged in Helium and Nitrogen

## ■ Results and Discussion

### Calibration

The quadratic regression and average compound response of the respective purge gases are listed in Table 3.

### Precision and Accuracy

Seven 0.5 ppb standards and seven 20 ppb calibration standards were analyzed in order to establish the precision and accuracy of the methods at both the low and the mid-range of the curves. These results are listed in Tables 4 and 5.

### Minimum Reporting Level (MRL)

The Minimum Reporting Level (MRL) confirmation was conducted using the procedure outlined in section 9.2.4 of the method, and seven aliquots of the 0.5 ppb calibration standard. The Upper and Lower limits for the Prediction Interval of Results (PIR) are calculated and shown in Table 6.

**Table 3:** Quadratic Regression and Average Response Factors for 7-Point Calibration

| Compound                    | Helium               |        | Nitrogen             |        | Compound                    | Helium               |        | Nitrogen             |        |
|-----------------------------|----------------------|--------|----------------------|--------|-----------------------------|----------------------|--------|----------------------|--------|
|                             | Quadratic Regression | Avg RF | Quadratic Regression | Avg RF |                             | Quadratic Regression | Avg RF | Quadratic Regression | Avg RF |
| dichlorodifluoromethane     | 1.000                | 0.202  | 0.995                | 0.179  | tetrachloroethene           | 0.999                | 0.244  | 0.999                | 0.246  |
| chlorodifluoromethane       | 1.000                | 0.053  | 0.999                | 0.057  | trans-1,3-dichloropropene   | 1.000                | 0.433  | 0.999                | 0.365  |
| chloromethane               | 1.000                | 0.537  | 0.999                | 0.534  | ethyl methacrylate          | 1.000                | 0.460  | 0.999                | 0.391  |
| vinyl chloride              | 1.000                | 0.406  | 0.999                | 0.411  | 1,1,2-trichloroethane       | 1.000                | 0.222  | 0.999                | 0.202  |
| 1,3-butadiene               | 1.000                | 0.442  | 0.999                | 0.420  | dibromochloromethane        | 1.000                | 0.237  | 0.999                | 0.231  |
| bromomethane                | 1.000                | 0.178  | 0.999                | 0.176  | 1,3-dichloropropane         | 1.000                | 0.501  | 0.999                | 0.444  |
| chloroethane                | 1.000                | 0.265  | 0.999                | 0.265  | 1,2-dibromomethane          | 1.000                | 0.260  | 0.999                | 0.240  |
| trichlorofluoromethane      | 1.000                | 0.403  | 0.998                | 0.446  | chlorobenzene               | 1.000                | 0.803  | 0.999                | 0.749  |
| diethyl ether               | 1.000                | 0.275  | 1.000                | 0.271  | ethylbenzene                | 1.000                | 1.359  | 0.999                | 1.301  |
| 1,1-dichloroethene          | 1.000                | 0.220  | 1.000                | 0.250  | 1,1,1,2-tetrachloroethane   | 1.000                | 0.258  | 0.999                | 0.244  |
| carbon disulfide            | 1.000                | 0.810  | 0.999                | 0.845  | xylene (m+p)                | 1.000                | 1.138  | 0.999                | 1.101  |
| methyl iodide               | 1.000                | 0.213  | 0.999                | 0.199  | xylene (o)                  | 1.000                | 1.138  | 0.999                | 1.097  |
| allyl chloride              | 1.000                | 0.423  | 0.999                | 0.422  | styrene                     | 1.000                | 0.942  | 0.999                | 0.852  |
| methylene chloride          | 1.000                | 0.489  | 0.999                | 0.469  | bromoform                   | 1.000                | 0.161  | 0.999                | 0.167  |
| trans-1,2-dichloroethene    | 1.000                | 0.395  | 1.000                | 0.416  | isopropylbenzene            | 1.000                | 1.342  | 0.999                | 1.259  |
| methyl acetate              | 1.000                | 0.382  | 0.999                | 0.402  | bromobenzene                | 0.999                | 1.252  | 1.000                | 1.045  |
| methyl-t-butyl ether (MtBE) | 1.000                | 0.903  | 1.000                | 0.416  | n-propylbenzene             | 0.999                | 2.638  | 1.000                | 2.428  |
| t-butyl alcohol (TBA)       | 1.000                | 0.047  | 0.999                | 0.057  | 1,1,1,2-tetrachloroethane   | 0.999                | 0.627  | 0.999                | 0.574  |
| diisopropyl ether (DIPE)    | 1.000                | 1.354  | 1.000                | 1.238  | 2-chlorotoluene             | 0.999                | 0.560  | 1.000                | 0.514  |
| 1,1-dichloroethane          | 1.000                | 0.507  | 1.000                | 0.557  | 1,3,5-trimethylbenzene      | 0.999                | 1.980  | 1.000                | 1.751  |
| t-butyl ethyl ether (ETBE)  | 1.000                | 0.946  | 0.999                | 0.862  | 1,2,3-trichloropropane      | 0.999                | 0.200  | 1.000                | 0.184  |
| cis-1,2-dichloroethene      | 0.999                | 0.454  | 1.000                | 0.453  | 4-chlorotoluene             | 0.999                | 0.584  | 1.000                | 0.535  |
| bromochloromethane          | 1.000                | 0.151  | 1.000                | 0.169  | t-butylbenzene              | 0.999                | 1.615  | 1.000                | 1.466  |
| chloroform                  | 1.000                | 0.460  | 1.000                | 0.486  | pentachloroethane           | 0.999                | 0.314  | 0.999                | 0.288  |
| carbon tetrachloride        | 1.000                | 0.263  | 0.999                | 0.286  | 1,2,4-trimethylbenzene      | 0.999                | 2.087  | 1.000                | 1.799  |
| tetrahydrofuran             | 1.000                | 0.257  | 1.000                | 0.280  | sec-butylbenzene            | 0.999                | 2.346  | 1.000                | 2.097  |
| 1,1,1-trichloroethane       | 1.000                | 0.361  | 1.000                | 0.385  | 4-isopropyltoluene          | 0.999                | 1.907  | 0.999                | 1.740  |
| 1,1-dichloropropene         | 1.000                | 0.126  | 1.000                | 0.132  | 1,3-dichlorobenzene         | 1.000                | 1.129  | 1.000                | 1.012  |
| 1-chlorobutane              | 1.000                | 0.632  | 0.999                | 0.640  | 1,4-dichlorobenzene         | 0.999                | 1.149  | 0.999                | 1.052  |
| benzene                     | 1.000                | 1.135  | 1.000                | 1.129  | n-butylbenzene              | 0.999                | 1.681  | 1.000                | 1.528  |
| t-amyl methyl ether (TAME)  | 1.000                | 0.847  | 1.000                | 0.708  | hexachloroethane            | 0.999                | 0.194  | 1.000                | 0.183  |
| 1,2-dichloroethane          | 1.000                | 0.391  | 1.000                | 0.380  | 1,2-dichlorobenzene         | 0.999                | 1.062  | 0.999                | 0.970  |
| trichloroethene             | 1.000                | 0.248  | 1.000                | 0.287  | 1,2-dibromo-3-chloropropane | 0.999                | 0.134  | 1.000                | 0.137  |
| t-amyl ethyl ether (TAEE)   | 1.000                | 0.718  | 1.000                | 0.648  | hexachlorobutadiene         | 0.999                | 0.289  | 1.000                | 0.279  |
| dibromomethane              | 1.000                | 0.152  | 0.999                | 0.170  | 1,2,4-trichlorobenzene      | 0.999                | 0.628  | 1.000                | 0.585  |
| 1,2-dichloropropane         | 1.000                | 0.289  | 0.999                | 0.310  | napthalene                  | 0.999                | 1.860  | 0.999                | 1.807  |
| bromodichloromethane        | 1.000                | 0.324  | 1.000                | 0.325  | 1,2,3-trichlorobenzene      | 1.000                | 0.565  | 0.999                | 0.537  |
| cis-1,3-dichloropropene     | 1.000                | 0.430  | 0.999                | 0.408  | Average                     | 1.000                | 0.687  | 0.999                | 0.640  |
| toluene                     | 1.000                | 1.214  | 0.999                | 1.151  |                             |                      |        |                      |        |



Table 4: Precision and Accuracy at 0.5 ppb (n=7)

| Compound                    | Helium                  |                           | Nitrogen                |                           | Compound                    | Helium                  |                           | Nitrogen                |                           |
|-----------------------------|-------------------------|---------------------------|-------------------------|---------------------------|-----------------------------|-------------------------|---------------------------|-------------------------|---------------------------|
|                             | Precision as %RSD (n=7) | Accuracy as % Recy. (n=7) | Precision as %RSD (n=7) | Accuracy as % Recy. (n=7) |                             | Precision as %RSD (n=7) | Accuracy as % Recy. (n=7) | Precision as %RSD (n=7) | Accuracy as % Recy. (n=7) |
| dichlorodifluoromethane     | 4.89                    | 85.34                     | 5.81                    | 66.29                     | tetrachloroethene           | 4.27                    | 91.74                     | 4.08                    | 98.00                     |
| chlorodifluoromethane       | 9.42                    | 100.03                    | 10.81                   | 96.34                     | trans-1,3-dichloropropene   | 3.01                    | 99.23                     | 3.80                    | 100.66                    |
| chloromethane               | 7.04                    | 99.63                     | 7.41                    | 76.11                     | ethyl methacrylate          | 3.74                    | 109.60                    | 3.30                    | 102.77                    |
| vinyl chloride              | 7.03                    | 102.89                    | 5.96                    | 80.77                     | 1,1,2-trichloroethane       | 6.41                    | 94.31                     | 6.61                    | 105.83                    |
| 1,3-butadiene               | 8.98                    | 95.17                     | 8.53                    | 75.57                     | dibromochloromethane        | 4.98                    | 100.51                    | 2.15                    | 103.71                    |
| bromomethane                | 11.95                   | 99.89                     | 9.35                    | 94.31                     | 1,3-dichloropropane         | 2.44                    | 101.94                    | 2.74                    | 99.43                     |
| chloroethane                | 8.78                    | 95.74                     | 8.33                    | 92.57                     | 1,2-dibromomethane          | 4.99                    | 98.14                     | 5.22                    | 98.11                     |
| trichlorofluoromethane      | 7.78                    | 100.06                    | 8.38                    | 77.94                     | chlorobenzene               | 3.15                    | 98.14                     | 2.87                    | 100.14                    |
| diethyl ether               | 6.33                    | 107.49                    | 5.37                    | 85.17                     | ethylbenzene                | 3.96                    | 103.43                    | 5.56                    | 100.09                    |
| 1,1-dichloroethene          | 7.85                    | 103.31                    | 9.85                    | 86.77                     | 1,1,1,2-tetrachloroethane   | 3.62                    | 102.14                    | 4.61                    | 103.80                    |
| carbon disulfide            | 6.54                    | 106.11                    | 9.00                    | 78.66                     | xylene (m+p)                | 4.37                    | 102.66                    | 4.58                    | 98.70                     |
| methyl iodide               | 7.04                    | 112.63                    | 4.70                    | 108.17                    | xylene (o)                  | 3.82                    | 103.97                    | 4.12                    | 96.77                     |
| allyl chloride              | 3.87                    | 101.34                    | 9.56                    | 87.74                     | styrene                     | 1.53                    | 97.17                     | 4.12                    | 101.11                    |
| methylene chloride          | 5.36                    | 103.54                    | 5.07                    | 94.17                     | bromoform                   | 5.47                    | 107.60                    | 6.17                    | 105.26                    |
| trans-1,2-dichloroethene    | 5.03                    | 109.63                    | 8.02                    | 88.34                     | isopropylbenzene            | 3.93                    | 100.37                    | 5.17                    | 100.51                    |
| methyl acetate              | 10.60                   | 103.89                    | 6.79                    | 96.63                     | bromobenzene                | 6.12                    | 96.66                     | 7.31                    | 18.90                     |
| methyl-t-butyl ether (MtBE) | 3.75                    | 98.14                     | 3.96                    | 92.09                     | n-propylbenzene             | 3.80                    | 97.54                     | 6.27                    | 86.20                     |
| t-butyl alcohol (TBA)       | 5.16                    | 124.15                    | 10.12                   | 95.26                     | 1,1,1,2-tetrachloroethane   | 8.38                    | 106.97                    | 5.10                    | 102.91                    |
| diisopropyl ether (DIPE)    | 3.69                    | 105.20                    | 3.69                    | 96.26                     | 2-chlorotoluene             | 5.59                    | 102.94                    | 5.21                    | 91.54                     |
| 1,1-dichloroethane          | 3.56                    | 119.00                    | 7.77                    | 92.11                     | 1,3,5-trimethylbenzene      | 3.37                    | 100.57                    | 6.58                    | 91.63                     |
| t-butyl ethyl ether (ETBE)  | 1.96                    | 100.34                    | 4.79                    | 92.94                     | 1,2,3-trichloropropane      | 4.81                    | 114.43                    | 6.22                    | 93.06                     |
| cis-1,2-dichloroethene      | 3.00                    | 98.94                     | 7.00                    | 92.11                     | 4-chlorotoluene             | 4.02                    | 102.91                    | 8.78                    | 95.23                     |
| bromochloromethane          | 4.56                    | 95.80                     | 8.69                    | 93.69                     | t-butylbenzene              | 2.21                    | 101.89                    | 7.41                    | 96.11                     |
| chloroform                  | 4.45                    | 110.89                    | 10.03                   | 88.26                     | pentachloroethane           | 4.16                    | 102.97                    | 5.59                    | 99.46                     |
| carbon tetrachloride        | 6.46                    | 92.37                     | 5.83                    | 88.49                     | 1,2,4-trimethylbenzene      | 3.01                    | 96.74                     | 4.06                    | 94.80                     |
| tetrahydrofuran             | 9.34                    | 104.66                    | 9.07                    | 88.69                     | sec-butylbenzene            | 3.65                    | 98.40                     | 7.08                    | 88.54                     |
| 1,1,1-trichloroethane       | 5.14                    | 100.74                    | 7.91                    | 89.69                     | 4-isopropyltoluene          | 3.39                    | 98.86                     | 7.14                    | 96.80                     |
| 1,1-dichloropropene         | 6.58                    | 101.17                    | 9.76                    | 89.14                     | 1,3-dichlorobenzene         | 2.46                    | 100.06                    | 5.00                    | 97.54                     |
| 1-chlorobutane              | 4.01                    | 103.69                    | 5.95                    | 85.57                     | 1,4-dichlorobenzene         | 2.19                    | 93.20                     | 6.23                    | 88.69                     |
| benzene                     | 2.81                    | 96.54                     | 8.24                    | 98.66                     | n-butylbenzene              | 4.01                    | 96.89                     | 7.27                    | 92.71                     |
| t-amyl methyl ether (TAME)  | 2.16                    | 100.49                    | 1.72                    | 100.03                    | hexachloroethane            | 8.31                    | 94.77                     | 8.51                    | 94.00                     |
| 1,2-dichloroethane          | 3.43                    | 105.06                    | 4.86                    | 87.57                     | 1,2-dichlorobenzene         | 2.69                    | 101.37                    | 4.20                    | 95.23                     |
| trichloroethene             | 4.62                    | 115.83                    | 8.55                    | 91.97                     | 1,2-dibromo-3-chloropropane | 4.38                    | 120.20                    | 6.24                    | 92.06                     |
| t-amyl ethyl ether (TAEE)   | 3.19                    | 99.23                     | 5.02                    | 98.94                     | hexachlorobutadiene         | 11.07                   | 93.46                     | 4.43                    | 75.97                     |
| dibromomethane              | 3.69                    | 101.40                    | 4.06                    | 95.46                     | 1,2,4-trichlorobenzene      | 5.86                    | 90.91                     | 6.58                    | 89.00                     |
| 1,2-dichloropropane         | 3.16                    | 109.83                    | 5.47                    | 94.37                     | naphthalene                 | 3.43                    | 101.31                    | 2.25                    | 98.74                     |
| bromodichloromethane        | 4.34                    | 101.51                    | 10.40                   | 99.77                     | 1,2,3-trichlorobenzene      | 4.20                    | 105.00                    | 2.43                    | 93.97                     |
| cis-1,3-dichloropropene     | 3.81                    | 102.43                    | 6.70                    | 99.97                     | Average                     | 4.95                    | 101.91                    | 6.20                    | 92.46                     |
| toluene                     | 3.72                    | 102.09                    | 4.99                    | 98.57                     |                             |                         |                           |                         |                           |

Table 5: Precision and Accuracy at 20 ppb (n=7)

| Compound                    | Helium                  |                           | Nitrogen                |                           | Compound                    | Helium                  |                           | Nitrogen                |                           |
|-----------------------------|-------------------------|---------------------------|-------------------------|---------------------------|-----------------------------|-------------------------|---------------------------|-------------------------|---------------------------|
|                             | Precision as %RSD (n=7) | Accuracy as % Recy. (n=7) | Precision as %RSD (n=7) | Accuracy as % Recy. (n=7) |                             | Precision as %RSD (n=7) | Accuracy as % Recy. (n=7) | Precision as %RSD (n=7) | Accuracy as % Recy. (n=7) |
| dichlorodifluoromethane     | 6.97                    | 93.44                     | 11.57                   | 97.36                     | tetrachloroethene           | 5.98                    | 96.59                     | 5.99                    | 93.89                     |
| chlorodifluoromethane       | 8.31                    | 100.82                    | 8.06                    | 81.39                     | trans-1,3-dichloropropene   | 2.19                    | 98.14                     | 2.04                    | 95.91                     |
| chloromethane               | 6.39                    | 99.28                     | 7.17                    | 93.91                     | ethyl methacrylate          | 2.02                    | 99.92                     | 1.60                    | 97.88                     |
| vinyl chloride              | 7.46                    | 97.60                     | 8.13                    | 94.70                     | 1,1,2-trichloroethane       | 2.03                    | 98.62                     | 2.33                    | 95.10                     |
| 1,3-butadiene               | 8.21                    | 97.05                     | 7.51                    | 93.50                     | dibromochloromethane        | 2.44                    | 100.51                    | 2.82                    | 96.13                     |
| bromomethane                | 5.73                    | 100.55                    | 6.74                    | 101.72                    | 1,3-dichloropropane         | 2.15                    | 98.61                     | 2.61                    | 95.75                     |
| chloroethane                | 6.54                    | 97.21                     | 8.16                    | 94.04                     | 1,2-dibromomethane          | 2.18                    | 98.67                     | 1.71                    | 96.80                     |
| trichlorofluoromethane      | 8.42                    | 97.56                     | 8.15                    | 95.92                     | chlorobenzene               | 3.44                    | 98.67                     | 3.67                    | 96.35                     |
| diethyl ether               | 3.45                    | 97.91                     | 3.67                    | 95.47                     | ethylbenzene                | 5.04                    | 99.83                     | 4.70                    | 95.79                     |
| 1,1-dichloroethene          | 7.69                    | 98.80                     | 5.99                    | 94.20                     | 1,1,1,2-tetrachloroethane   | 3.06                    | 99.04                     | 3.08                    | 95.42                     |
| carbon disulfide            | 7.41                    | 100.70                    | 5.42                    | 96.18                     | xylene (m+p)                | 5.02                    | 99.99                     | 4.46                    | 95.89                     |
| methyl iodide               | 5.10                    | 99.10                     | 6.58                    | 96.72                     | xylene (o)                  | 4.40                    | 99.76                     | 3.95                    | 96.59                     |
| allyl chloride              | 5.62                    | 100.23                    | 5.19                    | 94.84                     | styrene                     | 3.57                    | 99.15                     | 3.57                    | 95.84                     |
| methylene chloride          | 3.87                    | 98.09                     | 3.39                    | 94.47                     | bromoform                   | 3.35                    | 97.44                     | 2.60                    | 96.49                     |
| trans-1,2-dichloroethene    | 6.32                    | 101.36                    | 5.43                    | 96.58                     | isopropylbenzene            | 5.39                    | 99.19                     | 4.71                    | 95.69                     |
| methyl acetate              | 3.61                    | 103.36                    | 2.19                    | 92.30                     | bromobenzene                | 2.54                    | 99.26                     | 1.67                    | 95.88                     |
| methyl-t-butyl ether (MtBE) | 2.37                    | 98.32                     | 1.75                    | 94.93                     | n-propylbenzene             | 5.08                    | 101.74                    | 4.06                    | 95.81                     |
| t-butyl alcohol (TBA)       | 6.60                    | 102.59                    | 2.91                    | 89.37                     | 1,1,2,2-tetrachloroethane   | 2.67                    | 101.46                    | 1.27                    | 97.58                     |
| diisopropyl ether (DIPE)    | 3.63                    | 100.89                    | 2.35                    | 95.67                     | 2-chlorotoluene             | 4.24                    | 100.69                    | 3.54                    | 95.57                     |
| 1,1-dichloroethane          | 5.60                    | 100.50                    | 4.40                    | 95.94                     | 1,3,5-trimethylbenzene      | 4.83                    | 99.99                     | 3.71                    | 96.08                     |
| t-butyl ethyl ether (ETBE)  | 2.99                    | 99.41                     | 2.21                    | 96.65                     | 1,2,3-trichloropropane      | 2.69                    | 99.30                     | 1.73                    | 94.36                     |
| cis-1,2-dichloroethene      | 6.92                    | 101.61                    | 4.86                    | 96.32                     | 4-chlorotoluene             | 5.21                    | 99.12                     | 3.43                    | 95.11                     |
| bromochloromethane          | 3.88                    | 101.11                    | 2.99                    | 95.06                     | t-butylbenzene              | 5.35                    | 97.70                     | 5.56                    | 99.30                     |
| chloroform                  | 4.99                    | 99.68                     | 3.92                    | 94.97                     | pentachloroethane           | 2.88                    | 99.97                     | 3.20                    | 96.44                     |
| carbon tetrachloride        | 7.68                    | 99.90                     | 6.77                    | 94.30                     | 1,2,4-trimethylbenzene      | 4.49                    | 99.99                     | 2.98                    | 95.26                     |
| tetrahydrofuran             | 4.80                    | 104.87                    | 2.18                    | 95.96                     | sec-butylbenzene            | 5.80                    | 99.96                     | 5.57                    | 94.54                     |
| 1,1,1-trichloroethane       | 7.14                    | 100.09                    | 4.97                    | 94.89                     | 4-isopropyltoluene          | 5.06                    | 100.51                    | 4.12                    | 96.08                     |
| 1,1-dichloropropene         | 8.01                    | 98.49                     | 5.23                    | 96.67                     | 1,3-dichlorobenzene         | 4.64                    | 99.29                     | 3.45                    | 95.41                     |
| 1-chlorobutane              | 6.51                    | 98.99                     | 5.49                    | 96.46                     | 1,4-dichlorobenzene         | 3.42                    | 99.58                     | 2.78                    | 95.07                     |
| benzene                     | 5.59                    | 100.09                    | 4.30                    | 96.36                     | n-butylbenzene              | 5.89                    | 101.79                    | 4.30                    | 95.70                     |
| t-amyl methyl ether (TAME)  | 3.33                    | 98.37                     | 2.06                    | 96.11                     | hexachloroethane            | 5.46                    | 98.87                     | 5.31                    | 92.15                     |
| 1,2-dichloroethane          | 3.40                    | 100.29                    | 2.55                    | 97.24                     | 1,2-dichlorobenzene         | 3.47                    | 99.14                     | 2.52                    | 95.68                     |
| trichloroethene             | 6.63                    | 100.76                    | 4.62                    | 95.99                     | 1,2-dibromo-3-chloropropane | 3.84                    | 101.90                    | 1.83                    | 95.85                     |
| t-amyl ethyl ether (TAEE)   | 4.07                    | 99.97                     | 2.77                    | 98.02                     | hexachlorobutadiene         | 5.75                    | 102.24                    | 4.99                    | 94.87                     |
| dibromomethane              | 3.60                    | 101.41                    | 3.65                    | 95.69                     | 1,2,4-trichlorobenzene      | 4.31                    | 99.87                     | 2.07                    | 95.63                     |
| 1,2-dichloropropane         | 4.89                    | 101.74                    | 3.51                    | 95.85                     | naphthalene                 | 3.58                    | 101.17                    | 0.99                    | 97.94                     |
| bromodichloromethane        | 4.53                    | 100.80                    | 2.83                    | 96.90                     | 1,2,3-trichlorobenzene      | 4.74                    | 98.74                     | 2.22                    | 96.56                     |
| cis-1,3-dichloropropene     | 4.26                    | 99.41                     | 2.35                    | 96.60                     | Average                     | 4.69                    | 99.85                     | 3.96                    | 95.71                     |
| toluene                     | 4.54                    | 99.88                     | 4.04                    | 96.35                     |                             |                         |                           |                         |                           |

**Table 6:** MRL and calculated PIR Upper and Lower limits at 0.5 ppb, using helium purge gas (40 mL/minute for 11 minutes)

| Compound                   | Run 1 ppb | Run 2 ppb | Run 3 ppb | Run 4 ppb | Run 5 ppb | Run 6 ppb | Run 7 ppb | Avg. ppb | Std. Dev. ppb | Upper PIR | Lower PIR | Upper PIR Pass/Fail | Lower PIR Pass/Fail |
|----------------------------|-----------|-----------|-----------|-----------|-----------|-----------|-----------|----------|---------------|-----------|-----------|---------------------|---------------------|
| Dichlorofluoromethane      | 0.42      | 0.40      | 0.44      | 0.41      | 0.46      | 0.45      | 0.42      | 0.43     | 0.02          | 101.88    | 68.81     | pass                | pass                |
| Chlorodifluoromethane      | 0.42      | 0.50      | 0.57      | 0.51      | 0.55      | 0.51      | 0.46      | 0.50     | 0.05          | 137.39    | 62.67     | pass                | pass                |
| Chloromethane              | 0.48      | 0.45      | 0.53      | 0.52      | 0.47      | 0.55      | 0.49      | 0.50     | 0.04          | 127.44    | 71.82     | pass                | pass                |
| 1,3-Butadiene              | 0.47      | 0.41      | 0.50      | 0.46      | 0.49      | 0.56      | 0.45      | 0.48     | 0.04          | 129.06    | 61.29     | pass                | pass                |
| Vinyl Chloride             | 0.50      | 0.46      | 0.49      | 0.53      | 0.54      | 0.58      | 0.51      | 0.51     | 0.04          | 131.56    | 74.21     | pass                | pass                |
| Bromomethane               | 0.58      | 0.43      | 0.46      | 0.43      | 0.53      | 0.58      | 0.49      | 0.50     | 0.06          | 147.18    | 52.59     | pass                | pass                |
| Chloroethane               | 0.43      | 0.42      | 0.46      | 0.54      | 0.51      | 0.52      | 0.47      | 0.48     | 0.04          | 129.06    | 62.42     | pass                | pass                |
| Trichlorofluoromethane     | 0.50      | 0.44      | 0.54      | 0.49      | 0.50      | 0.57      | 0.47      | 0.50     | 0.04          | 130.91    | 69.21     | pass                | pass                |
| Diethyl Ether              | 0.56      | 0.49      | 0.53      | 0.60      | 0.56      | 0.53      | 0.51      | 0.54     | 0.03          | 134.45    | 80.52     | pass                | pass                |
| 1,1-Dichloroethene         | 0.51      | 0.43      | 0.52      | 0.54      | 0.52      | 0.58      | 0.53      | 0.52     | 0.04          | 135.46    | 71.16     | pass                | pass                |
| Iodomethane                | 0.54      | 0.51      | 0.51      | 0.60      | 0.59      | 0.62      | 0.57      | 0.56     | 0.04          | 144.06    | 81.19     | pass                | pass                |
| Carbon Disulfide           | 0.54      | 0.51      | 0.54      | 0.51      | 0.49      | 0.61      | 0.51      | 0.53     | 0.03          | 133.64    | 78.59     | pass                | pass                |
| Allyl Chloride             | 0.51      | 0.46      | 0.51      | 0.52      | 0.52      | 0.51      | 0.52      | 0.51     | 0.02          | 116.87    | 85.82     | pass                | pass                |
| Methylene Chloride         | 0.49      | 0.48      | 0.53      | 0.54      | 0.54      | 0.56      | 0.48      | 0.52     | 0.03          | 125.54    | 81.55     | pass                | pass                |
| MTBE                       | 0.48      | 0.48      | 0.52      | 0.50      | 0.49      | 0.51      | 0.46      | 0.49     | 0.02          | 112.71    | 83.57     | pass                | pass                |
| trans-1,2-dichloroethene   | 0.55      | 0.52      | 0.54      | 0.53      | 0.55      | 0.61      | 0.55      | 0.55     | 0.03          | 131.50    | 87.76     | pass                | pass                |
| methyl acetate             | 0.51      | 0.44      | 0.51      | 0.62      | 0.54      | 0.56      | 0.46      | 0.52     | 0.06          | 147.53    | 60.24     | pass                | pass                |
| TBA                        | 2.82      | 3.20      | 3.34      | 3.23      | 3.12      | 3.02      | 3.01      | 3.10     | 0.16          | 149.55    | 98.75     | pass                | pass                |
| diisopropyl ether          | 0.53      | 0.52      | 0.52      | 0.54      | 0.53      | 0.55      | 0.48      | 0.53     | 0.02          | 120.59    | 89.81     | pass                | pass                |
| 1,1-Dichloroethane         | 0.59      | 0.55      | 0.61      | 0.60      | 0.61      | 0.63      | 0.58      | 0.60     | 0.02          | 135.77    | 102.23    | pass                | pass                |
| t-butyl ethyl ether (ETBE) | 0.49      | 0.49      | 0.51      | 0.51      | 0.51      | 0.51      | 0.50      | 0.50     | 0.01          | 108.15    | 92.53     | pass                | pass                |
| cis-1,2-dichloroethene     | 0.50      | 0.49      | 0.49      | 0.49      | 0.50      | 0.53      | 0.47      | 0.49     | 0.01          | 110.70    | 87.19     | pass                | pass                |
| Bromochloromethane         | 0.46      | 0.50      | 0.50      | 0.49      | 0.44      | 0.50      | 0.47      | 0.48     | 0.02          | 113.12    | 78.48     | pass                | pass                |
| Chloroform                 | 0.53      | 0.52      | 0.55      | 0.58      | 0.55      | 0.60      | 0.56      | 0.55     | 0.02          | 130.43    | 91.34     | pass                | pass                |
| Carbon Tetrachloride       | 0.46      | 0.43      | 0.49      | 0.48      | 0.41      | 0.49      | 0.48      | 0.46     | 0.03          | 116.03    | 68.71     | pass                | pass                |
| THF                        | 0.53      | 0.53      | 0.45      | 0.57      | 0.50      | 0.61      | 0.48      | 0.52     | 0.05          | 143.39    | 65.93     | pass                | pass                |
| 1,1,1-trichloroethane      | 0.50      | 0.45      | 0.50      | 0.51      | 0.53      | 0.54      | 0.50      | 0.50     | 0.03          | 121.25    | 80.23     | pass                | pass                |
| 1,1-dichloropropene        | 0.51      | 0.47      | 0.54      | 0.47      | 0.56      | 0.47      | 0.52      | 0.51     | 0.03          | 127.54    | 74.80     | pass                | pass                |
| 1-chlorobutane             | 0.48      | 0.50      | 0.52      | 0.52      | 0.54      | 0.54      | 0.52      | 0.52     | 0.02          | 120.15    | 87.22     | pass                | pass                |
| Benzene                    | 0.49      | 0.45      | 0.48      | 0.50      | 0.49      | 0.49      | 0.48      | 0.48     | 0.01          | 107.29    | 85.79     | pass                | pass                |
| t-amyl methyl ether (TAME) | 0.50      | 0.50      | 0.49      | 0.51      | 0.48      | 0.52      | 0.51      | 0.50     | 0.01          | 109.10    | 91.87     | pass                | pass                |
| 1,2-Dichloroethane         | 0.52      | 0.51      | 0.51      | 0.56      | 0.52      | 0.54      | 0.52      | 0.53     | 0.02          | 119.32    | 90.79     | pass                | pass                |
| Trichloroethene            | 0.56      | 0.56      | 0.59      | 0.58      | 0.56      | 0.64      | 0.57      | 0.58     | 0.03          | 137.04    | 94.62     | pass                | pass                |
| t-amyl ethyl ether (TAEE)  | 0.51      | 0.47      | 0.49      | 0.51      | 0.49      | 0.52      | 0.49      | 0.50     | 0.02          | 111.79    | 86.67     | pass                | pass                |
| Dibromomethane             | 0.52      | 0.52      | 0.49      | 0.54      | 0.49      | 0.52      | 0.48      | 0.51     | 0.02          | 116.22    | 86.58     | pass                | pass                |
| 1,2-Dichloropropane        | 0.52      | 0.55      | 0.56      | 0.57      | 0.54      | 0.55      | 0.57      | 0.55     | 0.02          | 123.58    | 96.08     | pass                | pass                |
| Bromodichloromethane       | 0.48      | 0.50      | 0.49      | 0.50      | 0.52      | 0.55      | 0.52      | 0.51     | 0.02          | 118.96    | 84.07     | pass                | pass                |
| cis-1,3-Dichloropropene    | 0.49      | 0.50      | 0.48      | 0.54      | 0.52      | 0.53      | 0.53      | 0.51     | 0.02          | 117.88    | 86.98     | pass                | pass                |
| Toluene                    | 0.52      | 0.49      | 0.51      | 0.49      | 0.50      | 0.55      | 0.51      | 0.51     | 0.02          | 117.15    | 87.02     | pass                | pass                |
| Tetrachloroethane          | 0.45      | 0.44      | 0.43      | 0.49      | 0.48      | 0.46      | 0.47      | 0.46     | 0.02          | 107.25    | 76.24     | pass                | pass                |
| trans-1,3-Dichloropropene  | 0.51      | 0.50      | 0.47      | 0.50      | 0.50      | 0.51      | 0.48      | 0.50     | 0.01          | 111.07    | 87.39     | pass                | pass                |
| ethyl methacrylate         | 0.57      | 0.52      | 0.55      | 0.56      | 0.53      | 0.57      | 0.52      | 0.55     | 0.02          | 125.85    | 93.35     | pass                | pass                |
| 1,1,2-Trichloroethane      | 0.50      | 0.47      | 0.47      | 0.50      | 0.44      | 0.50      | 0.43      | 0.47     | 0.03          | 117.27    | 71.36     | pass                | pass                |
| Dibromochloromethane       | 0.51      | 0.53      | 0.46      | 0.48      | 0.51      | 0.53      | 0.49      | 0.50     | 0.03          | 120.34    | 80.69     | pass                | pass                |
| 1,3-dichloropropane        | 0.51      | 0.51      | 0.50      | 0.54      | 0.50      | 0.52      | 0.51      | 0.51     | 0.01          | 111.79    | 92.10     | pass                | pass                |
| 1,2-Dibromoethane          | 0.52      | 0.49      | 0.48      | 0.46      | 0.52      | 0.51      | 0.46      | 0.49     | 0.02          | 117.53    | 78.75     | pass                | pass                |
| Chlorobenzene              | 0.48      | 0.49      | 0.46      | 0.48      | 0.51      | 0.51      | 0.50      | 0.49     | 0.02          | 110.41    | 85.88     | pass                | pass                |
| 1,1,1,2-Tetrachloroethane  | 0.51      | 0.48      | 0.49      | 0.52      | 0.54      | 0.53      | 0.52      | 0.51     | 0.02          | 116.79    | 87.49     | pass                | pass                |
| Ethylbenzene               | 0.51      | 0.50      | 0.50      | 0.50      | 0.53      | 0.55      | 0.54      | 0.52     | 0.02          | 119.64    | 87.22     | pass                | pass                |
| Xylene (p&m)               | 1.00      | 1.03      | 1.03      | 0.99      | 1.01      | 1.13      | 1.00      | 1.03     | 0.04          | 120.43    | 84.89     | pass                | pass                |
| Styrene                    | 0.48      | 0.49      | 0.47      | 0.48      | 0.49      | 0.50      | 0.49      | 0.49     | 0.01          | 103.06    | 91.28     | pass                | pass                |
| Xylene (o)                 | 0.51      | 0.52      | 0.52      | 0.51      | 0.53      | 0.56      | 0.49      | 0.52     | 0.02          | 119.71    | 88.24     | pass                | pass                |
| Bromoform                  | 0.57      | 0.53      | 0.53      | 0.50      | 0.53      | 0.59      | 0.51      | 0.54     | 0.03          | 130.92    | 84.28     | pass                | pass                |
| Isopropylbenzene           | 0.49      | 0.48      | 0.50      | 0.48      | 0.52      | 0.54      | 0.50      | 0.50     | 0.02          | 115.99    | 84.75     | pass                | pass                |
| Bromobenzene               | 0.50      | 0.51      | 0.49      | 0.49      | 0.45      | 0.51      | 0.43      | 0.48     | 0.03          | 120.11    | 73.21     | pass                | pass                |
| 1,1,1,2-Tetrachloroethane  | 0.56      | 0.52      | 0.52      | 0.53      | 0.59      | 0.58      | 0.45      | 0.53     | 0.04          | 142.52    | 71.43     | pass                | pass                |
| n-Propylbenzene            | 0.48      | 0.48      | 0.47      | 0.48      | 0.50      | 0.53      | 0.48      | 0.49     | 0.02          | 112.24    | 82.85     | pass                | pass                |
| 2-Chlorotoluene            | 0.53      | 0.46      | 0.54      | 0.49      | 0.51      | 0.56      | 0.52      | 0.51     | 0.03          | 125.76    | 80.13     | pass                | pass                |
| 4-Chlorotoluene            | 0.53      | 0.52      | 0.48      | 0.53      | 0.50      | 0.54      | 0.50      | 0.51     | 0.02          | 119.32    | 86.51     | pass                | pass                |
| 1,3,5-Trimethylbenzene     | 0.48      | 0.49      | 0.49      | 0.51      | 0.50      | 0.54      | 0.50      | 0.50     | 0.02          | 113.99    | 87.16     | pass                | pass                |
| 1,2,3-trichloropropane     | 0.53      | 0.56      | 0.57      | 0.59      | 0.59      | 0.61      | 0.54      | 0.57     | 0.03          | 136.22    | 92.64     | pass                | pass                |
| tert-Butylbenzene          | 0.50      | 0.49      | 0.50      | 0.52      | 0.53      | 0.51      | 0.51      | 0.51     | 0.01          | 110.80    | 92.97     | pass                | pass                |
| pentachloroethane          | 0.50      | 0.48      | 0.53      | 0.52      | 0.54      | 0.54      | 0.50      | 0.51     | 0.02          | 119.95    | 86.00     | pass                | pass                |
| sec-Butylbenzene           | 0.49      | 0.47      | 0.49      | 0.50      | 0.50      | 0.53      | 0.47      | 0.49     | 0.02          | 112.64    | 84.16     | pass                | pass                |
| 1,2,4-Trimethylbenzene     | 0.49      | 0.47      | 0.49      | 0.48      | 0.48      | 0.51      | 0.47      | 0.48     | 0.01          | 108.29    | 85.20     | pass                | pass                |

Table 6 cont.

| Compound                    | Run 1 ppb | Run 2 ppb | Run 3 ppb | Run 4 ppb | Run 5 ppb | Run 6 ppb | Run 7 ppb | Avg. ppb | Std. Dev. ppb | Upper PIR | Lower PIR | Upper PIR Pass/Fail | Lower PIR Pass/Fail |
|-----------------------------|-----------|-----------|-----------|-----------|-----------|-----------|-----------|----------|---------------|-----------|-----------|---------------------|---------------------|
| 1,3-Dichlorobenzene         | 0.51      | 0.50      | 0.51      | 0.49      | 0.50      | 0.52      | 0.48      | 0.50     | 0.01          | 109.81    | 90.31     | pass                | pass                |
| 1,4-Dichlorobenzene         | 0.46      | 0.46      | 0.46      | 0.46      | 0.46      | 0.48      | 0.48      | 0.47     | 0.01          | 101.27    | 85.13     | pass                | pass                |
| Isopropyltoluene            | 0.49      | 0.48      | 0.49      | 0.49      | 0.50      | 0.53      | 0.48      | 0.49     | 0.02          | 112.15    | 85.56     | pass                | pass                |
| 1,2-Dichlorobenzene         | 0.51      | 0.50      | 0.52      | 0.52      | 0.49      | 0.52      | 0.49      | 0.51     | 0.01          | 112.18    | 90.57     | pass                | pass                |
| n-Butylbenzene              | 0.49      | 0.47      | 0.51      | 0.48      | 0.45      | 0.50      | 0.49      | 0.48     | 0.02          | 112.29    | 81.48     | pass                | pass                |
| Hexachloroethane            | 0.42      | 0.48      | 0.45      | 0.47      | 0.54      | 0.52      | 0.45      | 0.47     | 0.04          | 126.00    | 63.55     | pass                | pass                |
| 1,2-Dibromo-3-chloropropane | 0.60      | 0.56      | 0.59      | 0.65      | 0.60      | 0.60      | 0.63      | 0.60     | 0.03          | 141.07    | 99.33     | pass                | pass                |
| 1,2,4-Trichlorobenzene      | 0.48      | 0.47      | 0.49      | 0.45      | 0.44      | 0.45      | 0.40      | 0.45     | 0.03          | 112.03    | 69.80     | pass                | pass                |
| Naphthalene                 | 0.52      | 0.50      | 0.54      | 0.48      | 0.50      | 0.51      | 0.49      | 0.51     | 0.02          | 115.09    | 87.54     | pass                | pass                |
| Hexachlorobutadiene         | 0.41      | 0.45      | 0.46      | 0.40      | 0.50      | 0.57      | 0.48      | 0.47     | 0.05          | 134.46    | 52.45     | pass                | pass                |
| 1,2,3-Trichlorobenzene      | 0.52      | 0.55      | 0.54      | 0.51      | 0.54      | 0.54      | 0.48      | 0.53     | 0.02          | 122.48    | 87.52     | pass                | pass                |

### ■ Conclusion

The Encon Evolution and Centurion WS autosampler in conjunction with the Shimadzu GCMS-QP2010 SE performed very well using both the helium and nitrogen purge gases. The nitrogen and the helium purge gases met US EPA method 524.3 criteria and produced comparable results.

Overall, the principal difference between the two purge gases was exhibited in the compound response. When examining the overall compound response factors over the curve range, it is evident that the analytes' responses are slightly lower with the nitrogen purge gas as opposed to the helium purge gas due to slight differences in purge efficiency with the two gases.

### ■ References

1. Method 524.3, Measurement of Purgeable Organic Compounds in Water by Capillary Column Gas Chromatography/Mass Spectrometry, Version 1.0, June 2009.
2. Method 524.4, Measurement of Purgeable Organic Compounds in Water by Capillary Column Gas Chromatography/Mass Spectrometry (Using Nitrogen Purge Gas), Version 1, September 2011.
3. This application note was originally published by EST Analytical as "Drinking Water Analysis Conditions for US EPA Methods 524.3 and 524.4" in 2010. It is republished here with their permission.

■ **Ordering Information for Replacement Consumables**

The consumables used in this application note are shown in the table below. To order any of these items please contact Customer Service at Shimadzu Scientific Instruments at 1-800-477-1227, or visit our web store at <http://store.shimadzu.com>.

| Part Number     | Item Name                   | Photo   | Item Description  |
|-----------------|-----------------------------|---|---|
| 221-75962-30    | Capillary Column            |    | SH-RXI-624 SIL MS, 30 m x 0.25 mm x 1.40 µm   |
| 220-90784-10    | Inlet Liner                 |    | Low-volume Liner, 1.0 mm ID, Straight, 5/Pkg (Restek)   |
| 220-94775-10    | VOA Tuning Compound         |    | 1-Bromo-4-fluorobenzene (BFB), 5,000 µg/mL in P&T MeOH, 1 mL/ampule, CAS #: 460-00-4 (Restek) |
| Restek PN 30013 | 524.3 VOA Mega Mix          |    | 2,000 µg/mL each in P&T MeOH, 1 mL/ampule (Restek)  |
| Restek PN 30015 | 524.3 Internal Standard Mix |    | 2,000 µg/mL each in P&T MeOH, 1 mL/ampule (Restek)  |
| Restek PN 30016 | 524.3 Surrogate Mix         |  | 2,000 µg/mL each in P&T MeOH, 1 mL/ampule (Restek)  |
| Restek PN 30014 | 524.3 Gas Calibration Mix   |  | 2,000 µg/mL each in P&T MeOH, 1 mL/ampule (Restek)  |
| 220-94775-00    | n-Alkane Mix                |  | AART Standard for determination of Retention Index (RI) and Retention Times (RT)              |
| 220-94594-00    | Electronic Flow Meter       |  | ProFLOW 6000 Electronic Flow Meter (Restek)   |
| 220-94594-01    | Electronic Leak Detector    |  | Electronic Leak Detector With Hard-Sided Carrying Case and Universal Charger Set (Restek)     |

First Edition: June 2015



SHIMADZU Corporation  
[www.shimadzu.com/an/](http://www.shimadzu.com/an/)

SHIMADZU SCIENTIFIC INSTRUMENTS  
7102 Riverwood Drive, Columbia, MD 21046, USA  
Phone: 800-477-1227/410-381-1227, Fax: 410-381-1222  
URL: [www.ssi.shimadzu.com](http://www.ssi.shimadzu.com)

For Research Use Only. Not for use in diagnostic procedures.  
The contents of this publication are provided to you "as is" without warranty of any kind, and are subject to change without notice.  
Shimadzu does not assume any responsibility or liability for any damage, whether direct or indirect, relating to the use of this publication.

# Application News

## No. M267

### Gas Chromatography Mass Spectrometry

## Ultra-Fast Analysis of Volatile Organic Compounds in Water By Headspace-GC/MS/MS

### Introduction

Volatile organic compounds (VOCs) in environmental water and tap water are typically analyzed by headspace-GC/MS or by purge-and-trap-GC/MS. Because many of these VOCs exhibit low solubility in water and vaporize easily, analyses must be conducted as soon as possible following collection of the sample, and sample holding times are kept short to minimize losses of the volatile target compounds. Additionally, the analysis time for an individual sample should be as short as possible so the maximum number of samples can be analyzed before the holding times expire, preventing low bias in the results.

Analysis on a short, narrow-bore capillary column can shorten analysis times significantly without sacrificing chromatographic separation. However, some compounds co-elute and background interference from environmental matrices can increase when using short columns, potentially obstructing identification and quantitation of target compounds at low concentrations. Using a triple quadrupole GC/MS/MS, operated in the Multiple Reaction Monitoring (MRM) mode can improve overall sensitivity of the target compounds, while simultaneously improving selectivity when peaks co-elute, or in the presence of a complex matrix.

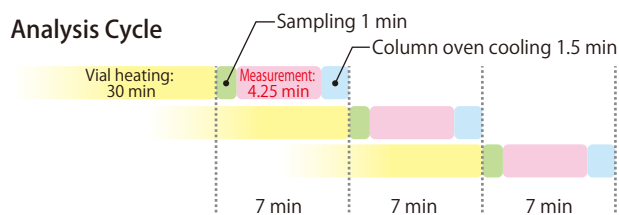
This study presents analysis conditions for 25 VOCs covering a range of volatility, using static headspace as the sample introduction technique, with GC/MS/MS operated in the MRM mode for detection and quantitation. Use of a short, narrow-bore capillary column permitted analysis of 8 samples per hour, or approximately one sample every 7 minutes.

### Experimental Instrumentation

The study was conducted using the Shimadzu HS-20 Loop Model headspace sampler, operated in the static headspace mode, with separation and compound identification using the Shimadzu GCMS-TQ8030 triple quadrupole mass spectrometer. Samples were also run in the SIM mode for comparison, to illustrate how the MRM mode can be used to provide selectivity when peaks co-elute, and to improve selectivity in a dirty matrix. Instrument configuration and operating conditions are shown in Table 1. Fig. 1 illustrates the HS-20 and GCMS-TQ8030 analysis cycle times.

**Table 1 Instrument Configuration and Operating Conditions for Analysis of VOCs by Headspace-GC/MS/MS**

|                      |  |
|----------------------|--|
| Headspace Instrument | Shimadzu HS-20 Loop Model  |
| Operation Mode       | Loop mode<br>Loop volume = 1 mL  |
| Sample Equilibration | 70 °C for 30 minutes<br>Agitation level: Off<br>Sample preparation overlap enabled   |
| Sampling Conditions  | Vial pressurization: 0.5 min, 50 kPa, equilibration 0.05 min<br>Loop loading: 0.25 min, equilibration 0.05 min<br>Sample injection = 0.1 min |
| Needle Flush         | 2 minutes  |
| Heated Zones         | Sample pathway = 200 °C<br>Transfer line = 200 °C  |
| GCMS Instrument      | Shimadzu GCMS-TQ8030   |
| Injection Mode       | Split injection, 30:1 split ratio  |
| Column               | Rxi-624Sil MS, 20 m x 0.18 mm I.D., x 1 µm   |
| Carrier Gas          | Helium<br>Constant linear velocity mode, 50 cm/sec   |
| Oven Program         | 70 °C, 40 °C/min to 220 °C, 0.5 min hold<br>Oven cooling 1.5 min<br>Sample-to-sample injection interval 7 minutes                            |
| MS Analysis Mode     | GC/MS in SIM mode, 2 ions per compound<br>GC/MS/MS in MRM mode, 2 transitions per compound<br>Event (loop) time = 0.15 sec                   |
| Heated Zones         | Ion source = 200 °C<br>GC-to-MS interface = 230 °C   |



**Fig. 1 HS-20 and GCMS-TQ8030 Analysis Cycle Times with One Sample Injected Approximately Every 7 Minutes.**

### Calibration Standards

Calibration standards were prepared by adding 3 grams of sodium chloride (pre-cleaned by heating to 300 °C, followed by cooling to room temperature) to five 20 mL headspace vials each containing 10 mL of VOC-free mineral water. Each 10-mL aliquot was spiked with 24 of the 25 target compounds to generate final concentrations of 0.1, 0.5, 1.0, 5.0, and 10 µg/L (parts-per-billion, ppb). The 1,4-dioxane was spiked at a concentration 10-fold higher than the other compounds because of its relatively higher solubility in water and lower sampling efficiency. Each calibration standard solution was also spiked with 4 internal standards (IS): vinyl chloride-d3 (4 ppb), p-bromofluorobenzene (2 ppb), fluorobenzene (2 ppb), and 1,4-dioxane-d8 (20 ppb). All calibration standards were analyzed using the conditions shown in Table 1.

## Results and Discussion

Fig. 2 shows the total ion current chromatogram (TIC) acquired from analysis of a 5 µg/L (ppb) calibration standard using the conditions shown in Table 1. From the chromatogram, it is evident that there are several co-eluting pairs, for example MTBE (#5) and *trans*-1,2-dichloroethylene (#6), or 1,2-dichloroethane (#11) and benzene (#12). In the case of vinyl chloride-d3 (#1) and vinyl

chloride (#2), the compounds also elute in the portion of the chromatogram subject to disruption from the early-eluting water peak. Careful selection of appropriate MRM transitions can provide sufficient selectivity to properly identify and integrate the individual co-eluting compounds, as well as those compounds affected by matrix interference, in this case water.

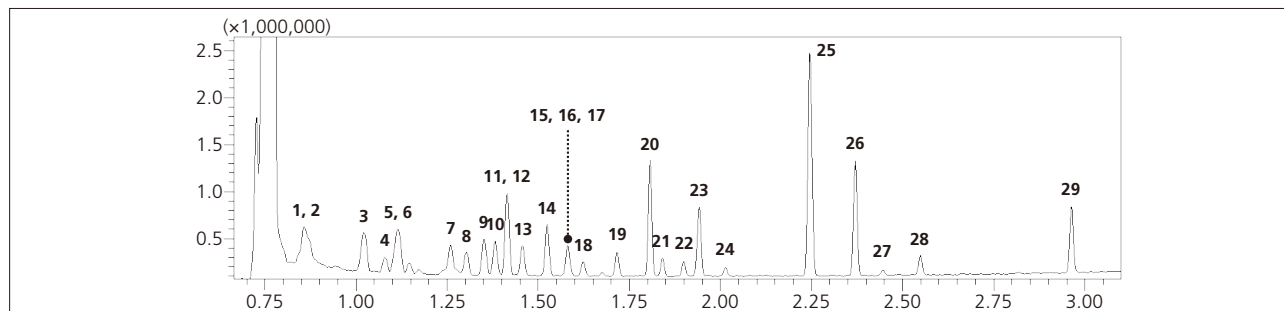


Fig. 2 Total Ion Current Chromatogram (TIC) of the 5 µg/L VOC Calibration Standard

Fig. 3 illustrates how the MRM mode can be used to selectively separate individual co-eluting peaks, and to eliminate background interference from the matrix. Vinyl chloride-d3 and vinyl chloride not only co-elute with one another, they elute on the tail of the large, early-eluting water matrix peak which makes unambiguous peak integration difficult when data are acquired in the SIM mode (top of Fig. 3). Using the MRM mode

(bottom of Fig. 3), interference from the water matrix peak is completely eliminated, and the two peaks are easily integrated for calibration or quantitation. Comparative SIM and MRM chromatograms of 1,4-dioxane-d8 (#15) and 1,2-dichloropropane (#16) provide an example of how the MRM mode is used to selectively separate co-eluting peaks from one another when they have similar mass spectral fragments.

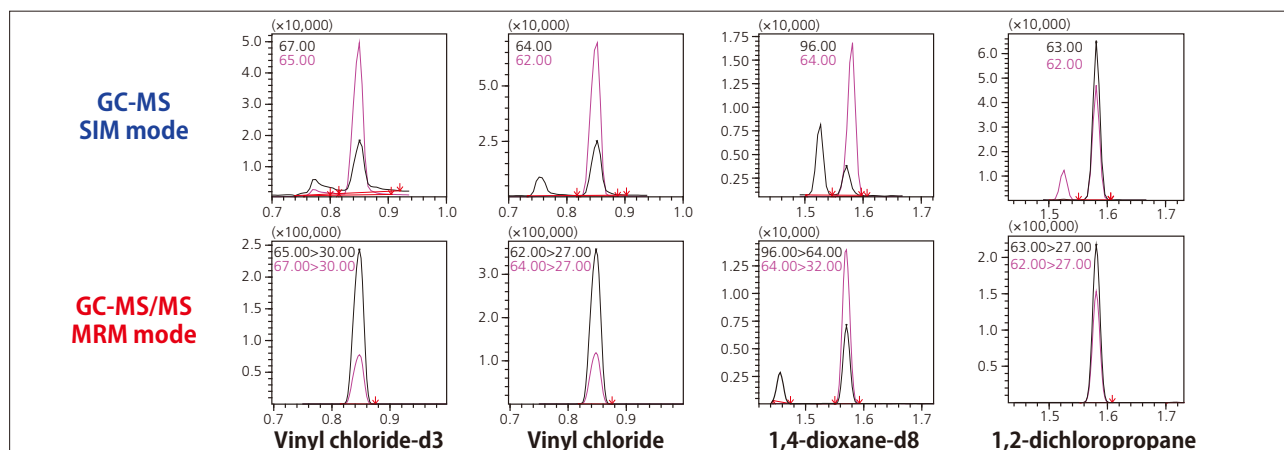


Fig. 3 SIM Chromatogram (Top) and MRM Chromatogram (Bottom) of Selected VOCs

Statistical results of the calibration are shown in Table 2. Relative Standard Deviation (RSD) of concentrations from n=5 analyses was 10.6 % or better for all compounds, and correlation coefficients (R) were 0.999 or higher, indicating linearity across the calibration range of 0.1 to 10.0 µg/L.

Table 2 Calibration Statistics for VOCs

| Peak No. | Compound Name                      | %RSD | Correlation Coefficient (R) |
|----------|------------------------------------|------|-----------------------------|
| 1        | Vinyl chloride-d3 (ISTD)           | -    | -                           |
| 2        | Vinyl chloride                     | 2.13 | 0.9997                      |
| 3        | 1,1-dichloroethylene               | 4.28 | 0.9998                      |
| 4        | Dichloromethane                    | 5.57 | 0.9997                      |
| 5        | Methyl-t-butyl ether (MTBE)        | 5.02 | 0.9997                      |
| 6        | <i>Trans</i> -1,2-dichloroethylene | 5.53 | 0.9996                      |
| 7        | <i>Cis</i> -1,2-dichloroethylene   | 5.17 | 0.9996                      |
| 8        | Trichloromethane                   | 9.47 | 0.9995                      |
| 9        | 1,1,1-trichloroethane              | 3.63 | 0.9995                      |
| 10       | Carbon tetrachloride               | 1.32 | 0.9997                      |
| 11       | 1,2-dichloroethane                 | 8.71 | 0.9993                      |
| 12       | Benzene                            | 6.13 | 0.99976                     |
| 13       | Fluorobenzene (ISTD)               | -    | -                           |
| 14       | Trichloroethylene                  | 3.81 | 0.9996                      |
| 15       | 1,4-dioxane-d8 (ISTD)              | -    | -                           |

| Peak No. | Compound Name                     | %RSD | Correlation Coefficient (R) |
|----------|-----------------------------------|------|-----------------------------|
| 16       | 1,2-dichloropropane               | 6.77 | 0.9997                      |
| 17       | 1,4-dioxane                       | 9.71 | 0.9999                      |
| 18       | Bromodichloromethane              | 6.34 | 0.9996                      |
| 19       | <i>Cis</i> -1,3-dichloropropene   | 4.51 | 0.9995                      |
| 20       | Toluene                           | 7.21 | 0.9996                      |
| 21       | <i>Trans</i> -1,3-dichloropropene | 4.23 | 0.9994                      |
| 22       | 1,1,2-trichloroethane             | 4.91 | 0.9994                      |
| 23       | Tetrachloroethylene               | 5.36 | 0.9996                      |
| 24       | Dibromochloromethane              | 8.08 | 0.9996                      |
| 25       | <i>m</i> -, <i>p</i> -xylene      | 4.06 | 0.9997                      |
| 26       | <i>o</i> -xylene                  | 2.76 | 0.9997                      |
| 27       | Bromoform                         | 10.6 | 0.9996                      |
| 28       | 4-bromofluorobenzene              | -    | -                           |
| 29       | 1,4-dichlorobenzene               | 1.22 | 0.9998                      |

## Conclusion

Operating conditions for the Shimadzu HS-20 Loop Model headspace sampler and the Shimadzu GCMS-TQ8030 triple quadrupole mass spectrometer have been optimized for analysis of up to 8 VOC samples per hour. The triple quadrupole Multiple Reaction Monitoring mode provided sensitivity to detect and quantitate VOC compounds at 0.1 ppb, and to selectively analyze compounds which co-elute with one another, or which are subject to interference from the matrix.

## Materials Used

The VOC-free mineral water was from Volvic. All analytical standards were acquired from Wako Pure Chemical Industries, Ltd., as shown below.

- VOC compound mixture, Code No. 224-01581
- Vinyl chloride, Code No. 515-01081
- 1,4-dioxane, Code No. 049-28791
- Vinyl chloride-d3, Code No. 512-36141
- *p*-bromofluorobenzene + fluorobenzene, Code No. 029-15021
- 1,4-dioxane-d8, Code No. 042-29021

# Application News

## No. C144

### Liquid Chromatograph Mass Spectrometry

## Analysis of Bromate in Tap Water Using a Triple Quadrupole LC/MS/MS (1)

Bromate in tap water is generated by advanced water treatment processes such as ozone disinfection in the process of water purification. Potassium bromate has been classified by the IARC (1999) as a Group B2 substance which is possibly carcinogenic to humans, and was added to the water quality standards of Japan in 2004. Upon its addition, ion chromatography with post-column absorption spectroscopy was designated as the testing method for bromate. (Annex table 18 of "Method Determined by the Minister of Health, Labour and Welfare on the Basis of the Ordinance Provisions Relating to Water Quality Standards",

Notification No. 261 issued by the Ministry of Health, Labour and Welfare of Japan (MHLW) in 2003)

In December 2016, the MHLW gathered opinions for partial amendment of this method, and as given in annex table 18-2 "Liquid Chromatography-Mass Spectrometry", mass spectrometry was proposed as a new testing method (proposal) for bromate.

This article introduces the results of our examination of LC/MS/MS analysis using an anion exchange column based on this new testing method (proposal).

M. Tanaka, H. Horiike

### ■ Examination of Conditions for Analysis Using an Anion Exchange Column

With reversed-phase LC conditions, which are widely used for LC/MS/MS, bromate is difficult to retain because it is a high polarity compound. Therefore in this research, we examined conditions such as mobile phases using the anion exchange column that is given as an example in the new testing method (proposal), and established analysis conditions which enable the retention of bromate (Table 1).

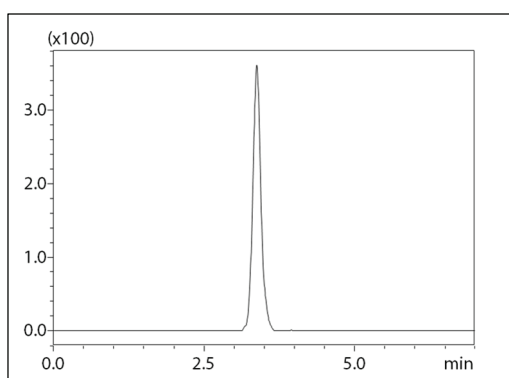
Fig. 1 shows a chromatogram of the standard solution of 0.001 mg/L, which is equivalent to one-tenth the water quality

criterion. With these analysis conditions, bromate was eluted at 3.4 min, exhibiting good retention and a good peak shape.

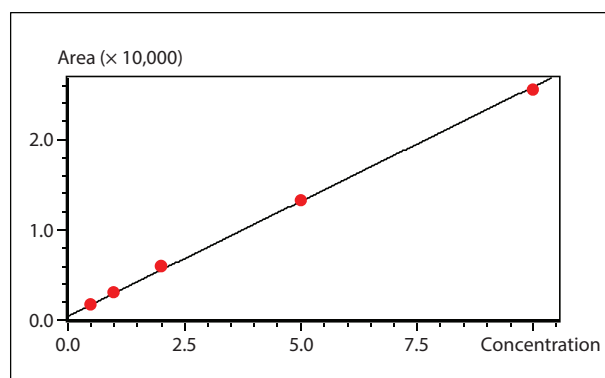
Fig. 2 shows a five-point calibration curve for concentrations ranging from 0.0005 mg/L to 0.01 mg/L. Favorable linearity was achieved with a correlation coefficient (R) of 0.999 and a coefficient of determination (R<sup>2</sup>) of 0.998.

**Table 1 Analysis Conditions**

|                     |   |
|---------------------|---|
| Column              | : GL Sciences SYPRON AX-1 (100 mm L, × 2.1 mm I.D., 5 μm)                           |
| Mobile phases       | : A) 25 mmol/L Ammonium acetate-water<br>B) Acetonitrile<br>A/B = 70/30 (vol./vol.) |
| Flow rate           | : 0.2 mL/min  |
| Column temp.        | : 40 °C   |
| Injection Volume    | : 10 μL   |
| Probe Voltage       | : -1 kV (ESI-Negative)  |
| DL temp.            | : 100 °C  |
| Block Heater temp.  | : 300 °C  |
| Interface temp.     | : 300 °C  |
| Nebulizing gas flow | : 2 L/min   |
| Drying gas flow     | : 10 L/min  |
| Heating gas flow    | : 10 L/min  |
| MRM transition      | : Bromate ion <i>m/z</i> 129.00>112.95  |



**Fig. 1 Chromatogram of Standard Solution of 0.001 mg/L Bromate**



**Fig. 2 Calibration Curve of Bromate (0.0005 mg/L to 0.01 mg/L)**



### Verifying Separation from Anion Impurities in Tap Water

Bromate in tap water can be selectively detected by MRM measurement with LC/MS/MS. However, anions such as sulfate ions also exist in the tap water sample. By separating the chromatograms of such anion impurities from that of bromate, determination precision in tap water analysis is expected to be improved.

This necessity can also be verified by the statement in the liquid chromatography-mass spectrometry method (proposal): When the water for testing includes a high concentration of sulfate ions, set analysis conditions under which sulfate ions elute from the separation column.

Fig. 3 shows the chromatograms obtained by adding bromate to a tap water sample (from Kanagawa Prefecture), and monitoring

bromate together with anion impurities. Sulfate ions, chloride ions, nitrate ions, and chlorate ions in the tap water are also retained and eluted, indicating that bromate is separated from these ions.

In general, regarding analysis using an anion exchange column, elution of anion impurities requires adding a high concentration of salt to the mobile phase, thereby requiring more frequent instrument maintenance. However, the ammonium acetate concentration of the aqueous mobile phase used in these analysis conditions is 25 mmol/L, and is therefore about the same level as with regular conditions for reversed-phase LC/MS/MS analysis. This means that these analysis conditions are also robust with regard to instrument maintenance.

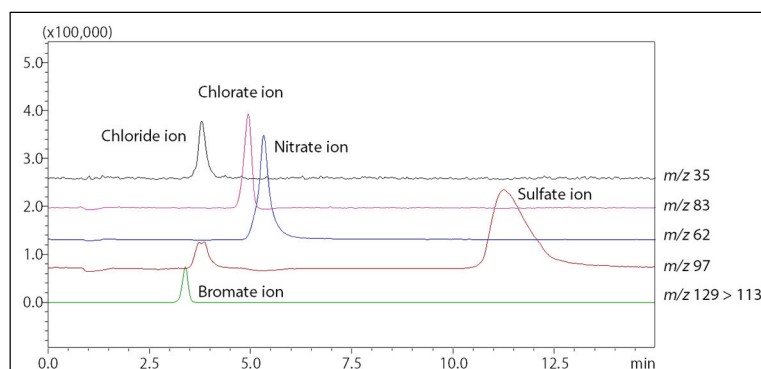


Fig. 3 Chromatograms of Anion Impurities and Bromate in Tap Water

### Spike-and-Recovery Test with Tap Water

A spike-and-recovery test of bromate was performed using tap water (from Kanagawa Prefecture). Tap water was measured after being spiked with 0.01 mg/L bromate, which is the water quality criterion, and with 0.001 mg/L bromate, which is a concentration one-tenth the water quality criterion. The obtained chromatograms showed no significant disturbance originating from impurities in tap water (Fig. 4).

Table 2 shows the accuracy and precision calculated from the analysis results of these samples. With both spiking concentrations, the standard given in the validation guideline (notification issued by the MHLW in Sept. 2012) was fulfilled.

In this examination of analysis according to the new testing method (proposal), we confirmed that bromate in a tap water sample can be detected down to a concentration of 0.001 mg/L, which is one-tenth the criterion, without pretreatment.

Unlike the current ion chromatography with post-column absorption spectroscopy method, this analysis method does not require preparation of a reagent, and is therefore expected to improve the efficiency of water quality testing and contribute to reducing the burden of tests.

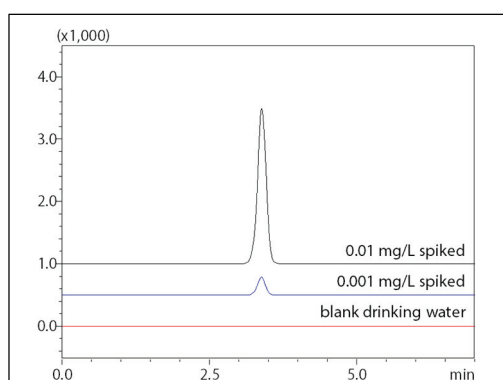


Fig. 4 Chromatograms of Blank Tap Water and Tap Water Spiked with Bromate Standard

Table 2 Spike-and-Recovery Test Results of Bromate (n = 5)

| Spiked Conc. mg/L | Accuracy | Precision %RSD |
|-------------------|----------|----------------|
| 0.01              | 96.7 %   | 2.2            |
| 0.001             | 84.6 %   | 5.2            |

First Edition: Mar. 2017



For Research Use Only. Not for use in diagnostic procedure.

This publication may contain references to products that are not available in your country. Please contact us to check the availability of these products in your country.

The content of this publication shall not be reproduced, altered or sold for any commercial purpose without the written approval of Shimadzu. Company names, product/service names and logos used in this publication are trademarks and trade names of Shimadzu Corporation or its affiliates, whether or not they are used with trademark symbol "TM" or "®". Third-party trademarks and trade names may be used in this publication to refer to either the entities or their products/services. Shimadzu disclaims any proprietary interest in trademarks and trade names other than its own.

The information contained herein is provided to you "as is" without warranty of any kind including without limitation warranties as to its accuracy or completeness. Shimadzu does not assume any responsibility or liability for any damage, whether direct or indirect, relating to the use of this publication. This publication is based upon the information available to Shimadzu on or before the date of publication, and subject to change without notice.

Shimadzu Corporation

www.shimadzu.com/an/

# Application News

## No. C96

### Liquid Chromatography Mass Spectrometry

## Analysis of Phenols in Drinking Water Using Triple Quadrupole LC/MS/MS (LCMS-8040)

Phenols can be formed as wastewater purification and disinfectant by-products, and Japan's Ministry of Health, Labour and Welfare have designated six phenols, including phenol, 2-chlorophenol, 4-chlorophenol, 2,4-dichlorophenol, 2,6-dichlorophenol, and 2,4,6-trichlorophenol as subject to water quality standards requirements. The method designated (by the ministry notification) for analysis of these six phenol components is solid-phase extraction – derivatization – GC/MS.

Here, we introduce an example of phenol analysis by UHPLC/MS/MS. Unlike the use of GC/MS for this analysis, LC/MS/MS does not require derivatization, and therefore simplifies the analysis process<sup>1), 2)</sup>.

### ■ UHPLC/MS/MS Analysis

Sample pretreatment was conducted using the same solid phase extraction procedure as that designated in the notification (solid-phase extraction – derivatization – GC/MS) (Fig. 2). For the solid phase column, an N-containing poly (styrene-divinylbenzene-methacrylic acid) copolymer was used.

Fig. 1 shows the results obtained from measurement of a standard solution containing 0.4 µg/L of each of the six analytical target substances. Since the test water sample concentration is increased 50-fold using solid phase extraction, the equivalent concentration in the test water becomes 0.008 µg/L. Table 1 shows the linearity of the calibration curves over a concentration range equivalent to 0.008 to 1 µg/L in the test water sample, and the repeatability using a concentration of 0.008 µg/L. Excellent linearity and repeatability were obtained with respect to all of the components.

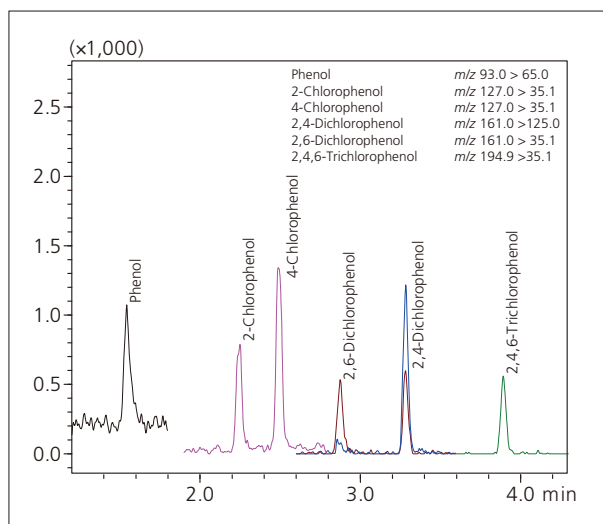


Fig. 1 Mass Chromatograms (MRM) of Phenols

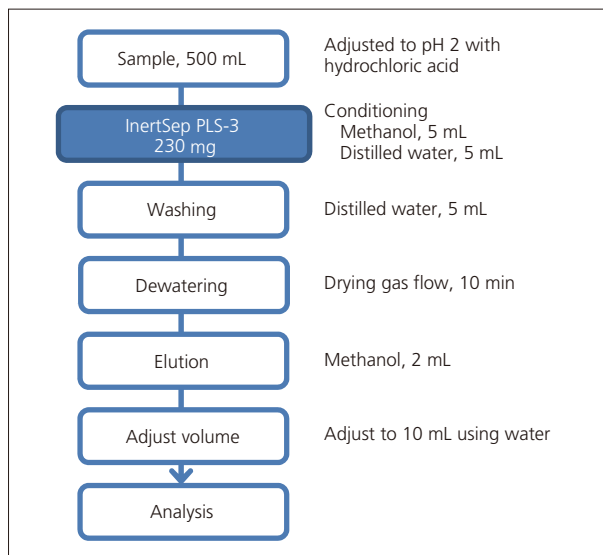


Fig. 2 Pretreatment Flow

Table 1 Calibration Curves and Repeatability

|                       | Injection Sample Concentration (µg/L) | Test Water Sample Concentration (µg/L) | Coefficient of Determination R <sup>2</sup> | Area Repeatability %RSD (Calibration point minimum concentration) |
|-----------------------|---------------------------------------|--|---|---|
| Phenol                | 0.4 – 50                              | 0.008 – 1                              | 0.99938                                     | 7.4   |
| 2-Chlorophenol        | 0.4 – 50                              | 0.008 – 1                              | 0.99967                                     | 4.5   |
| 4-Chlorophenol        | 0.4 – 50                              | 0.008 – 1                              | 0.99960                                     | 5.0   |
| 2,4-Dichlorophenol    | 0.4 – 50                              | 0.008 – 1                              | 0.99966                                     | 3.9   |
| 2,6-Dichlorophenol    | 0.4 – 50                              | 0.008 – 1                              | 0.99960                                     | 7.0   |
| 2,4,6-Trichlorophenol | 0.4 – 50                              | 0.008 – 1                              | 0.99960                                     | 7.8   |

### ■ Spike and Recovery Test for Drinking Water

Using this analytical method, we conducted spike and recovery testing of the phenols in tap water. Fig. 3 shows mass chromatograms (MRM) of a blank tap water sample subjected to pretreatment, and a test water sample spiked with six different phenol compounds, each at a concentration equivalent to 0.08 µg/L in the test sample. These spike concentrations

were approximately equivalent to 1/10 the reference values of the phenols (in terms of the amount of phenol, 0.005 mg/L or less). Regarding the tap water samples analyzed here, there was no indication of significant interference due to contaminating components (Fig. 3). In addition, good recoveries were obtained, ranging between and 90 to 110 % (Table 2).

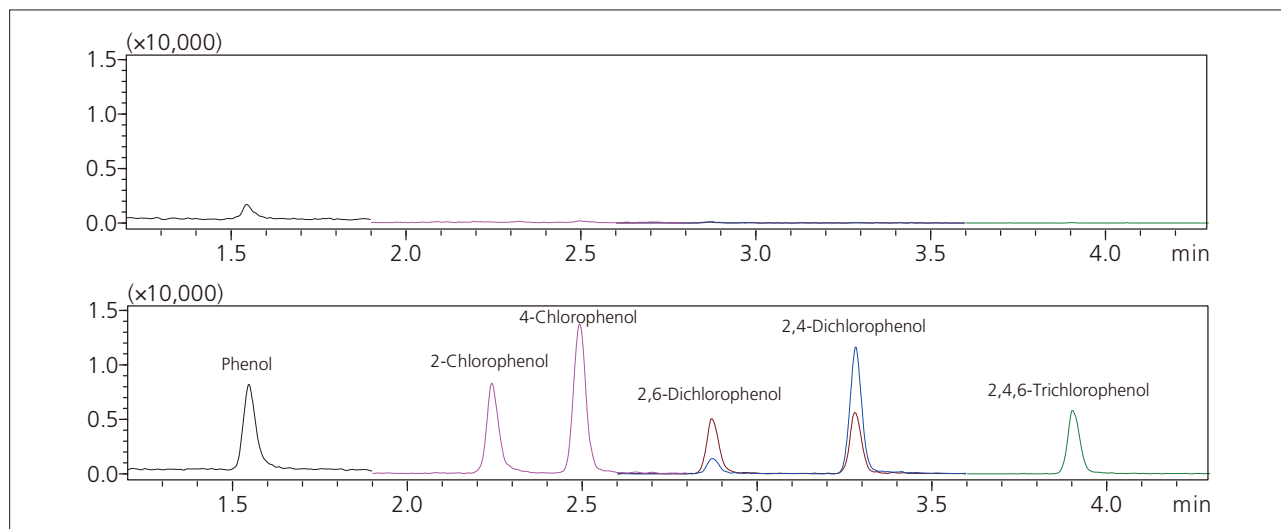


Fig. 3 Mass Chromatograms (MRM) of Drinking Water (Upper: Blank, Lower: 0.08 µg/L spiked)

Table 2 Results of Spike and Recovery Test (n=5)

|                       | Recovery %<br>(Corresponding to 0.08 µg/L) | Recovery %<br>(Corresponding to 0.4 µg/L) |
|-----------------------|--|---|
| Phenol                | 103.7                                      | 99.6                                      |
| 2-Chlorophenol        | 104.8                                      | 100.1                                     |
| 4-Chlorophenol        | 104.1                                      | 100.2                                     |
| 2,4-Dichlorophenol    | 104.6                                      | 100.4                                     |
| 2,6-Dichlorophenol    | 102.0                                      | 100.3                                     |
| 2,4,6-Trichlorophenol | 105.6                                      | 99.3                                      |

Table 3 Analytical Conditions

|                          |   |
|--------------------------|---|
| Column                   | : InertSustain C18 HP (100 mm L. × 2.1 mm I.D., 3 µm)   |
| Mobile Phases            | : A) Water<br>: B) Methanol   |
| Flowrate                 | : 0.5 mL/min  |
| Time Program             | : B conc. 40 % (0 min) – 95 % (4.8 – 5.4 min) – 40 % (5.41 – 7.5 min)   |
| Column Temperature       | : 40 °C   |
| Injection Volume         | : 50 µL   |
| Probe Voltage            | : -3.5 kV (APCI-negative mode)  |
| DL Temperature           | : 200 °C  |
| Block Heater Temperature | : 200 °C  |
| Interface Temperature    | : 350 °C  |
| Nebulizing Gas Flow      | : 3 L/min (Air)   |
| Drying Gas Flow          | : 5 L/min (N <sub>2</sub> )   |
| MRM Transition           | : Phenol: <i>m/z</i> 93.0 > 65.0, 2-Chlorophenol: <i>m/z</i> 127.0 > 35.1, 4-Chlorophenol: <i>m/z</i> 127.0 > 35.1,<br>2,4-Dichlorophenol: <i>m/z</i> 161.0 > 125.0, 2,6-Dichlorophenol: <i>m/z</i> 161.0 > 35.1,<br>2,4,6-Trichlorophenol: <i>m/z</i> 194.9 > 35.1 |

#### [References]

- 1) Reiji Kubota, Norihiro Kobayashi, Maiko Tahara, Naoki Sugimoto, Yoshiaki Ikarashi: Investigation of the Analytical Method for Phenols and Chlorophenols in Tap Water by Solid-Phase Extraction - LC/MS; The 22<sup>nd</sup> Annual Conference and Symposium of Japan Society for Environmental Chemistry (JEC), p.586-587 (2013)
- 2) Reiji Kubota, Norihiro Kobayashi, Kaori Saito, Nobuhiro Saito, Toshiya Suzuki, Yuki Kosugi, Minako Tanaka, Taku Tsukamoto, Hiroshi Hayashida, Tatsuya Hirabayashi, Isoaki Yamamoto, Yoshiaki Ikarashi: Validity Assessment of Phenols Investigation Method by Solid-Phase Extraction - LC/MS; The 23<sup>rd</sup> Annual Conference and Symposium of Japan Society for Environmental Chemistry (JEC), p.126-127 (2014)

# Application News

## No.L508

### High Performance Liquid Chromatography

## Analysis of Formaldehyde by the Derivatization-High Performance Liquid Chromatography Method, in Compliance with Water Quality Standards

Revisions to the ministerial ordinance related to water quality standards were announced on March 30 2016 (Japan's Ministry of Health, Labour and Welfare Ordinance No. 115; enacted April 1 2016), and Ordinance No. 261 was partially revised. The derivatization-high performance liquid chromatography method was added therein as a formaldehyde inspection method. The standard value remains unchanged at 0.08 mg/L max.

This article introduces an example of the analysis of formaldehyde in compliance with the derivatization-high performance liquid chromatography method (hereinafter the official method), using a Shimadzu Prominence-i high performance liquid chromatograph.

### ■ Analytical Method

In the official method, phosphoric acid and a solution of 2,4-dinitrophenylhydrazine (hereinafter DNPH solution) are added to the sample as derivatization reagents. If the water sample contains residual chlorine, 0.1 to 0.5 mL of an ammonium chloride solution (1 w/v%) is added per 100 mL of the sample, after which derivatization is performed. The pretreatment procedure from the official method is shown in Fig. 1.

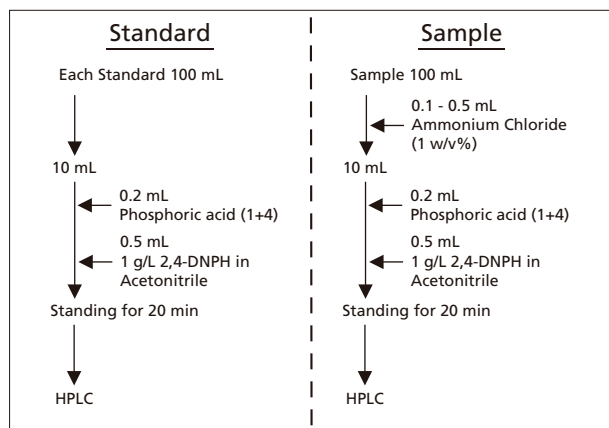


Fig. 1 Pretreatment

### ■ Analysis of Standard Solution

The analysis result for a standard formaldehyde solution (0.005 mg/L) at a concentration of 1/10 the standard value or less is shown in Fig. 2. The analytical conditions are shown in Table 1. When the same derivatization was performed with respect to ultrapure water, trace formaldehyde was detected. However, it was confirmed that the value was less than that prescribed in the validity evaluation guidelines\* for tap water quality inspection procedures.

\* In the "Validity Evaluation Guidelines for Tap Water Quality Inspection Procedures" from the Japan's Ministry of Health, Labour and Welfare, if an interference peak is evident, you must check that the area of the interference peak is less than 1/3 the area of the peak obtained from a standard solution at 1/10 the concentration of the standard value.

Table 1 Analytical Conditions

|              |  |
|--------------|--|
| Column       | : Shim-pack VP-ODS (150 mm L. × 4.6 mm I.D.) |
| Mobile Phase | : Water/Acetonitrile = 50/50(v/v)            |
| Flowrate     | : 1.0 mL/min                                 |
| Column Temp. | : 40 °C                                      |
| Injection    | : 50 µL                                      |
| Detection    | : UV 360 nm (Cell temp. 40 °C)               |

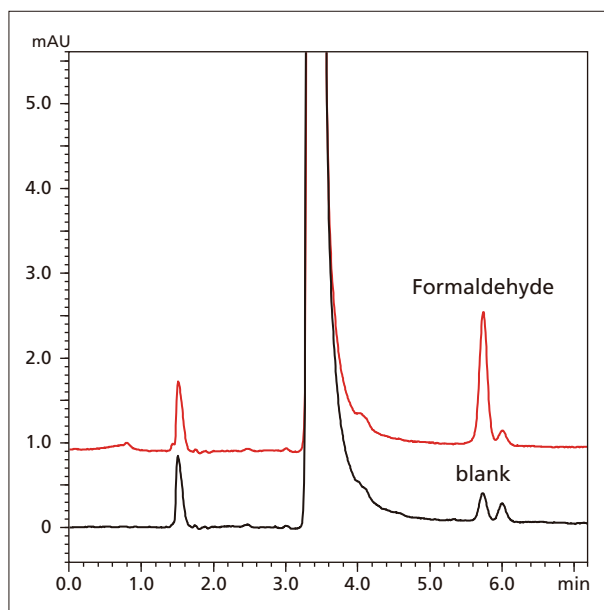


Fig. 2 Chromatograms for a Standard Formaldehyde Solution (Upper: Formaldehyde at 0.005 mg/L; Lower: Blank)

■ **Linearity**

A calibration curve for the standard formaldehyde solution is shown in Fig. 3. It was created for a concentration range of 0.005 to 0.1 mg/L, as prescribed in the official method. Favorable linearity is indicated, with a coefficient of correlation ( $R^2$ ) of 0.999 or higher.

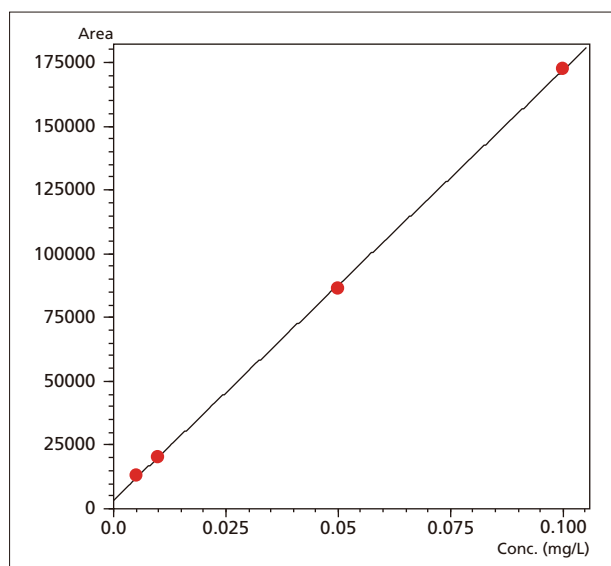


Fig. 3 Calibration Curve

■ **Repeatability**

The chromatograms, retention times, and relative standard deviations (%RSD) for area are shown in Fig. 4 for a standard formaldehyde solution (0.005 mg/L), at a concentration of 1/10 the standard value or less, analyzed six times.

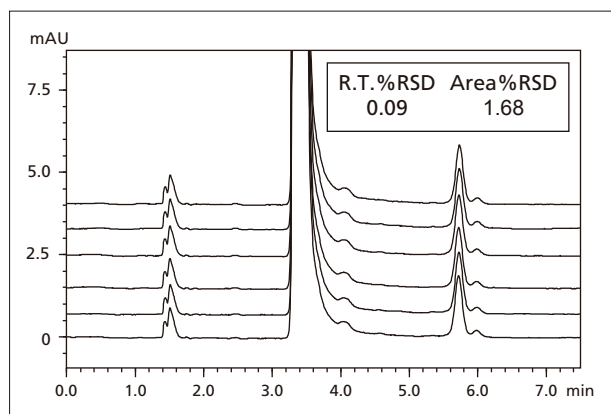


Fig. 4 Chromatograms for a Standard Formaldehyde Solution (0.005 mg/L, n = 6)

■ **Analysis of Tap Water**

The analysis result for a standard formaldehyde solution at 0.008 mg/L, a concentration of 1/10 the standard value, added to tap water are shown in Fig. 5. The tap water used in this instance contained formaldehyde at the standard concentration or less, but this did not have an impact on the quantitative results. The additive recovery ratio was 109 %.

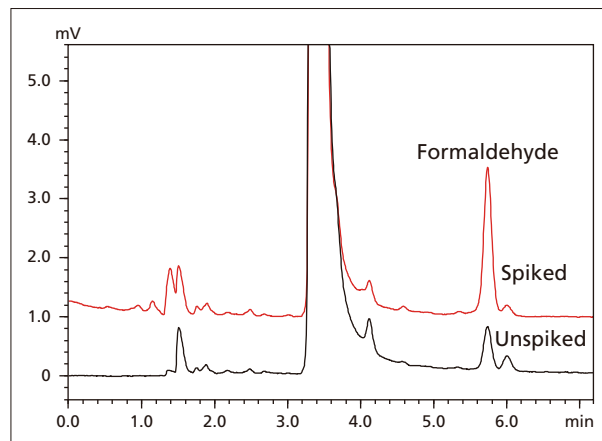


Fig. 5 Chromatograms for Tap Water (Upper: Spiked with 0.008 mg/L Formaldehyde; Lower: Unspiked)

# Application News

## No. C128

### Liquid Chromatography Mass Spectrometry

## Analysis of Formaldehyde in Drinking Water Using Triple Quadrupole LC/MS/MS [LCMS-8050]

Formaldehyde is highly toxic and the levels are regulated in many products, including cosmetics, textiles, household products, and indoor (work) environments since it is also one of the causes of sick house syndrome. Japan has a water quality standard in place for formaldehyde levels in drinking water (0.08 mg/L), and a test method is specified in appended table 19, solvent extraction-derivatization-gas chromatography-mass spectrometry method, of the methods determined by the Minister of Health, Labour and Welfare based on prescriptions of ministerial ordinance concerning water standards (Health, Labour and Welfare Ministry notification No. 261 of July 22, 2003).

Revisions to the ministerial ordinance concerning water

standards were promulgated on March 30, 2016 (Health, Labour and Welfare Ministry notification No. 115 effective April 1, 2016), adding two new formaldehyde test methods, appended table 19-2 derivatization-high performance liquid chromatography method and appended table 19-3 derivatization-liquid chromatography-mass spectrometry method, to the methods determined by the Minister of Health, Labour and Welfare based on prescriptions of ministerial ordinance concerning water standards. We describe an example of simultaneous analysis of formaldehyde and another compound that requires examination, acetaldehyde, according to the derivatization-liquid chromatography-mass spectrometry method that was added to the ministerial ordinance.

### Sample Pretreatment

The pretreatment described by the new derivatization-liquid chromatography-mass spectrometry test method shown in appended table 19-3 removes the need for solvent extraction with hexane and iodometric titration, which are both performed in the current method shown in appended table 19 solvent extraction-derivatization-gas chromatography-mass spectrometry method.

The new test method also reduces standing time after derivatization to around one-sixth of the current method, and overall is expected to provide substantial improvements in pretreatment efficiency.

The work flows of pretreatment by each test method are shown in Fig. 1.

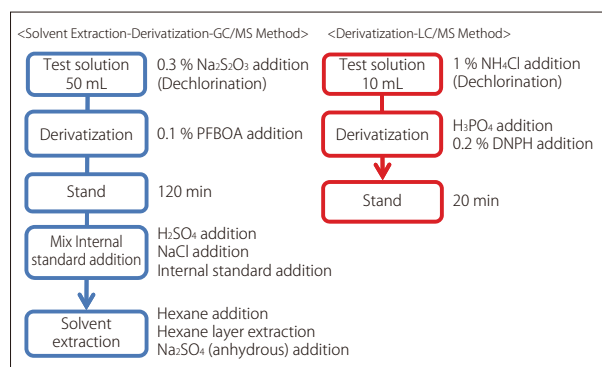


Fig. 1 Pretreatment Work Flows

### Analysis of Formaldehyde-Acetaldehyde Reference Standard Mixture

A formaldehyde-acetaldehyde reference standard mixture at 0,005 mg/L, which is less than 1/10th the water standards level for formaldehyde (0.08 mg/L), was derivatized with DNPH and analyzed. MRM chromatograms of this analysis are shown in Fig. 2.

Good results were obtained, with peak area repeatability (n=6) that met the condition of %RSD < 20 % for both DNPH derivatized formaldehyde and acetaldehyde.

Analytical conditions are shown in Table 2.

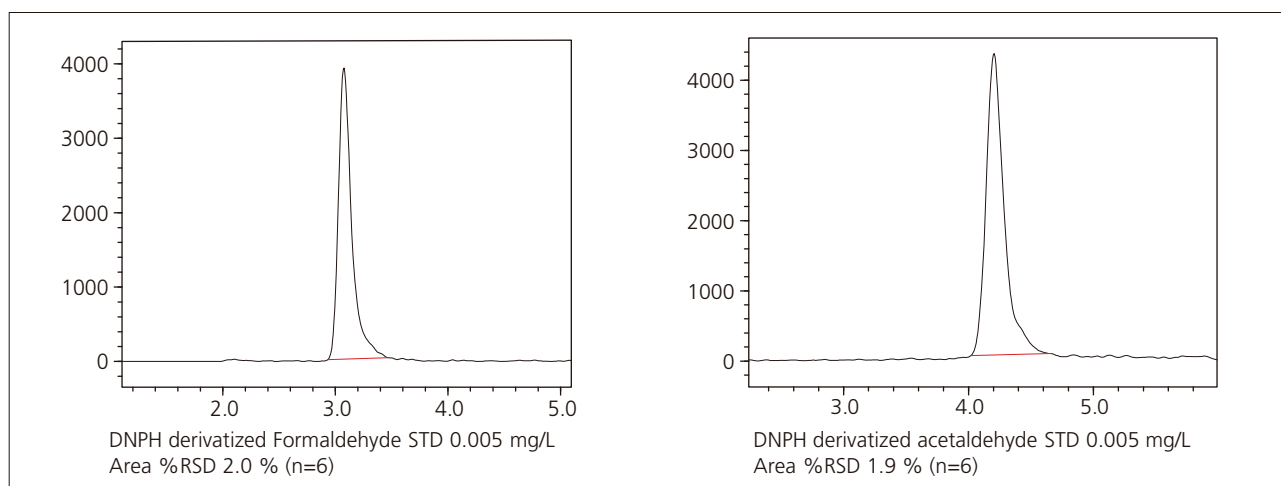


Fig. 2 MRM Chromatograms of DNPH Derivatized Formaldehyde and Acetaldehyde Reference Standards

Fig. 3 shows calibration curves (n=6) created for DNPH derivatized formaldehyde and acetaldehyde based on five points in the concentration range of 0.005 to 0.100 mg/L, which includes 0.008 mg/L that is 1/10th

the water standards level for formaldehyde. Good linearity was obtained, with a coefficient of determination ( $R^2$ ) > 0.999 for both calibration curves.

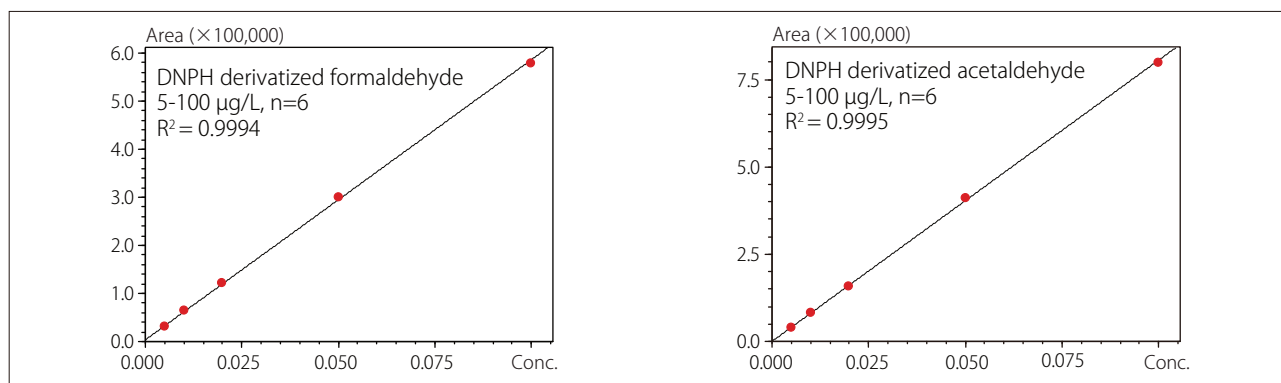


Fig. 3 Absolute Calibration Curves on Five Points

### ■ Spike Recovery Test in Drinking Water

A spike recovery test was performed for formaldehyde and acetaldehyde using actual drinking water. Drinking water was spiked with formaldehyde and acetaldehyde at the water standards level of formaldehyde (0.08 mg/L) and one-tenth this concentration (0.008 mg/L), after which DNPH derivatization was performed.

MRM chromatograms obtained from drinking water spiked with the two compounds at 0.008 mg/L are shown in Fig. 4. Selectivity was confirmed since the peak areas for the two compounds in blank drinking water samples were one-third or below peak areas in the spiked drinking water samples.

Good recovery of 101 % to 105 % was obtained for both compounds at both the water standards level of formaldehyde and one-tenth this concentration.

Table 1 Spike Recovery Test Results (n=6)

| Recovery                        | 0.08 mg/L spike | 0.008 mg/L spike |
|---------------------------------|-----------------|------------------|
| (DNPH derivatized) Formaldehyde | 103.0 %         | 101.4 %          |
| (DNPH derivatized) Acetaldehyde | 104.3 %         | 101.1 %          |

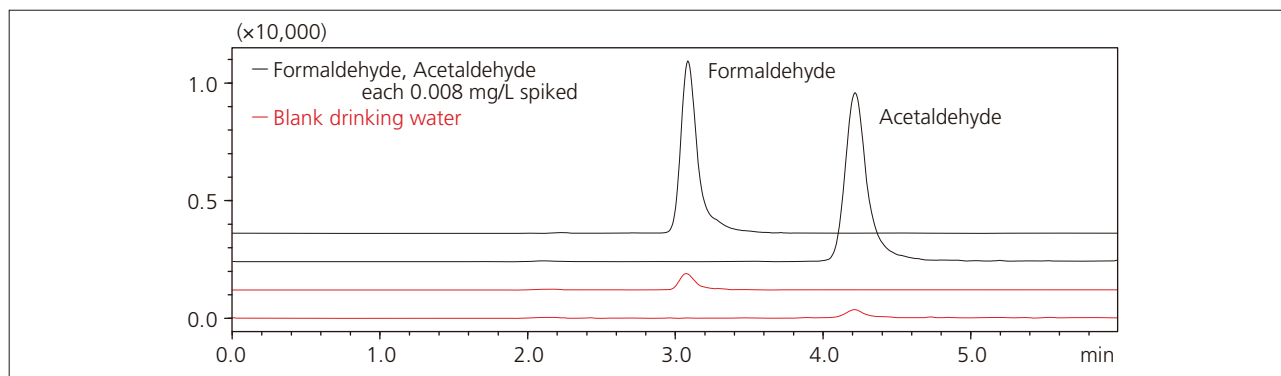


Fig. 4 MRM Chromatograms of Drinking Water Blank and Drinking Water Spiked with Formaldehyde and Acetaldehyde by DNPH Derivatization

Table 2 Analytical Conditions

|                    |   |                          |  |
|--------------------|---|--------------------------|--|
| Column             | : Shim-pack FC-ODS (75 mm L. x 2.0 mm I.D., 3 μm, Shimadzu) | DL Temperature           | : 150 °C   |
| Mobile Phases      | : Water / Acetonitrile = 50 / 50 (v/v)                      | Block Heater Temperature | : 300 °C   |
| Flow Rate          | : 0.20 mL/min   | Interface Temperature    | : 200 °C   |
| Column Temperature | : 30 °C   | Nebulizing Gas Flow      | : 2 L/min  |
| MS program         | : FCV2 = 1 (0.001 min) → FCV2 = 0 (2.000 min)               | Drying Gas Flow          | : 10 L/min   |
| Injection Volume   | : 1.0 μL  | Heating Gas Flow         | : 10 L/min   |
| Probe Voltage      | : -3 kV (ESI-Negative)                                      | MRM Transition           | : Formaldehyde <i>m/z</i> 209.00 > 151.00<br>Acetaldehyde <i>m/z</i> 223.00 > 163.00 |

First Edition: Jul. 2016



For Research Use Only. Not for use in diagnostic procedure.

This publication may contain references to products that are not available in your country. Please contact us to check the availability of these products in your country.

The content of this publication shall not be reproduced, altered or sold for any commercial purpose without the written approval of Shimadzu. Company names, product/service names and logos used in this publication are trademarks and trade names of Shimadzu Corporation or its affiliates, whether or not they are used with trademark symbol "TM" or "®". Third-party trademarks and trade names may be used in this publication to refer to either the entities or their products/services. Shimadzu disclaims any proprietary interest in trademarks and trade names other than its own.

The information contained herein is provided to you "as is" without warranty of any kind including without limitation warranties as to its accuracy or completeness. Shimadzu does not assume any responsibility or liability for any damage, whether direct or indirect, relating to the use of this publication. This publication is based upon the information available to Shimadzu on or before the date of publication, and subject to change without notice.

Shimadzu Corporation  
www.shimadzu.com/an/

# Application News

## No. C119

### Liquid Chromatography Mass Spectrometry

## Analysis of Cartap, Pyraclonil, and Ferimzone in Drinking Water Using a Triple Quadrupole LC/MS/MS System

Cartap, pyraclonil, and ferimzone are widely used agricultural insecticides, with pyraclonil and ferimzone intended for use in flooded rice fields. These pesticides are designated for monitoring based on target values for drinking water quality control. Though target values were specified, no method for inspecting them has been specified so far.

However, in March 2015, the Japan's Ministry of Health, Labour and Welfare, Health Service Bureau, Water Supply Division issued a notification (No. 0325 Item 3 - 6) specifying the use of LC/MS/MS for water quality

control inspections of cartap, pyraclonil, and ferimzone, for which an inspection method was not previously specified.

This article describes an example of inspecting samples for these three components by simultaneous analysis using a liquid chromatograph-mass spectrometer system, as specified in Appendix Method 20-2. Cartap decomposes to nereistoxin in water, so the Cartap is measured as nereistoxin. Ferimzone includes type E and Z isomers, the concentrations of which are totaled to determine the Ferimzone concentration.

### Analyzing a Standard Mixture Solution of Nereistoxin (Cartap), Pyraclonil, and Ferimzone

A standard solution with 1/100 the target concentration of nereistoxin, pyraclonil, and ferimzone respectively was measured, with the resulting MRM chromatogram shown in Fig. 1.

Fig. 2 shows calibration curves for a concentration range that includes 1/100 of each target concentration value, as well as indicating the repeatability at the lowest calibration point concentration. The results showed good linearity and repeatability for all substances.

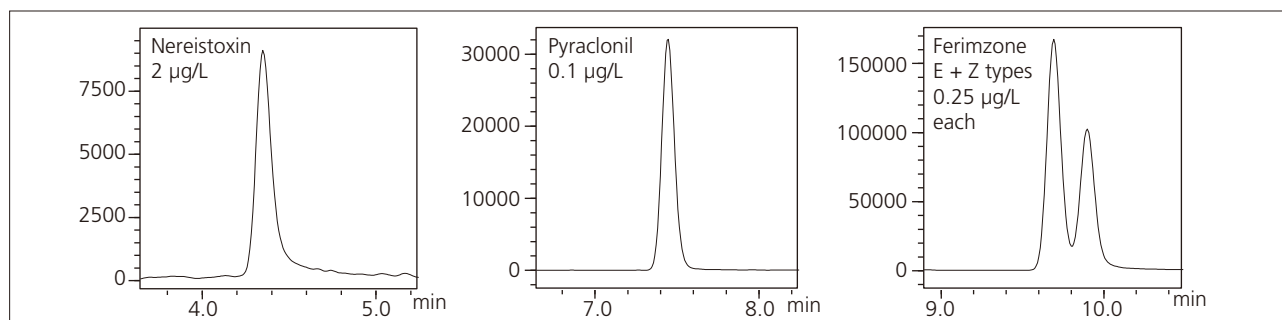


Fig. 1 MRM Chromatograms for Each Substance in a Standard Mixture Solution of Nereistoxin (Cartap), Pyraclonil, and Ferimzone

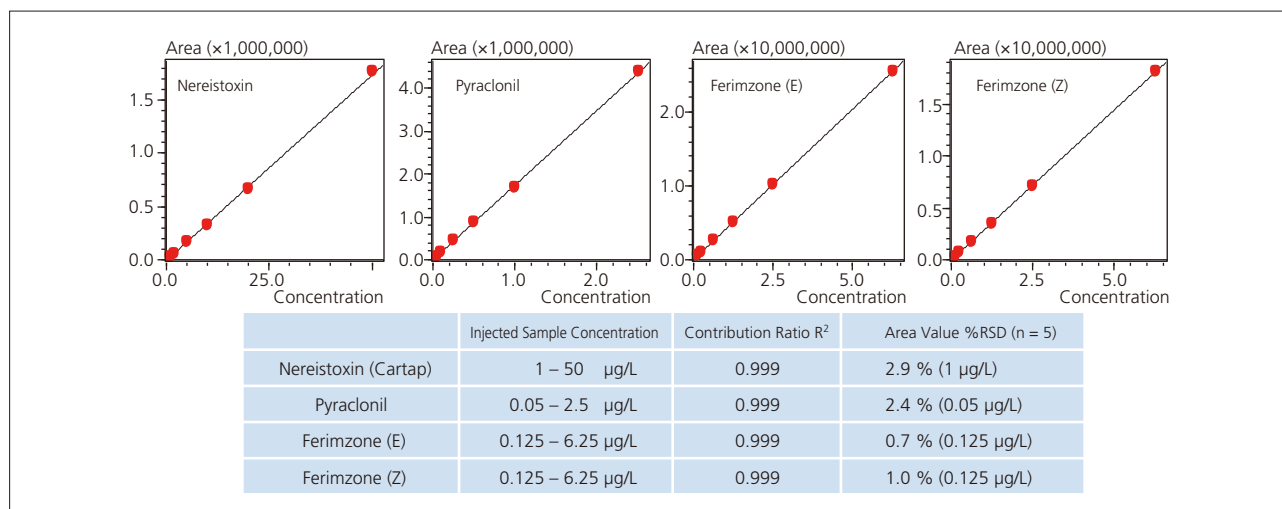


Fig. 2 Contribution Ratio and Area Repeatability



### ■ Spike and Recovery Test Using Drinking Water

Drinking water was spiked with nereistoxin, pyraclonil, and ferimzone to test the recovery rate. The public drinking water was treated to remove residual chlorine using sodium thiosulfate, rather than sodium ascorbate. (20 mg was added per liter of drinking water.)

Fig. 3 shows MRM chromatograms of blank pretreated drinking water and pretreated drinking water spiked with 1/100 the target value of each substance (2 µg/L nereistoxin, 0.1 µg/L pyraclonil, and 0.125 µg/L each of ferimzone types E and Z).

The recovery rate was calculated from the average of area values measured from five repetitions.

Good results were obtained for each substance, with 102 % recovery for nereistoxin, 95 % for ferimzone E, 100 % for ferimzone Z, and 95 % for pyraclonil.

Analytical conditions for these measurements are listed in Table 2.

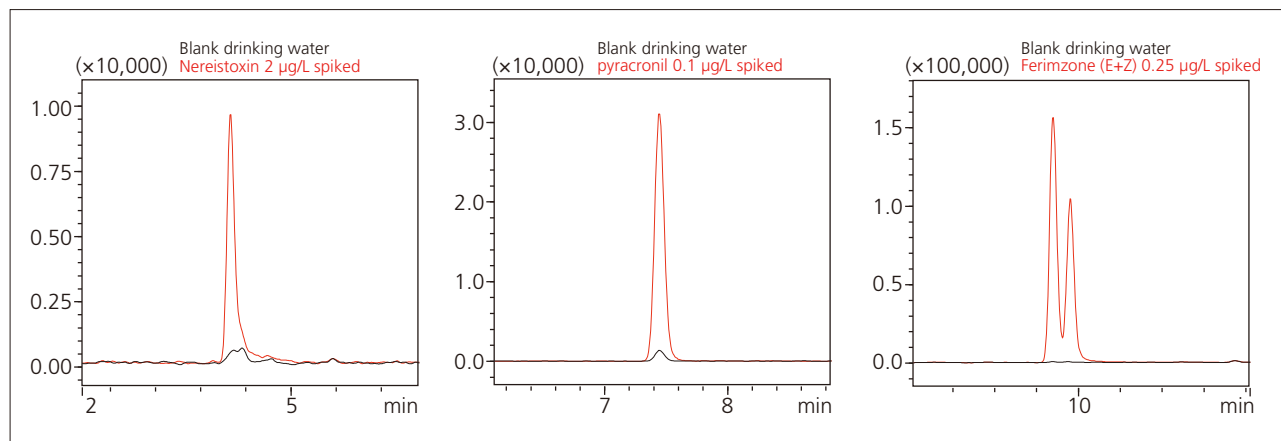


Fig. 3 MRM Chromatograms for Blank Drinking Water and Drinking Water Spiked with Nereistoxin, Pyraclonil, and Ferimzone

Table 1 Spike and Recovery Test Results (n = 5)

|                      | Spike Concentration | Recovery Rate (%) |
|----------------------|---------------------|-------------------|
| Nereistoxin (Cartap) | 2 µg/L              | 102               |
| Pyraclonil           | 0.1 µg/L            | 95                |
| Ferimzone (E)        | 0.125 µg/L          | 95                |
| Ferimzone (Z)        | 0.125 µg/L          | 100               |

Table 2 Analytical Conditions

|                          |   |
|--------------------------|---|
| Column                   | : L-Column2 ODS (75 mm L. × 2.1 mm I.D., 2 µm, CERI)  |
| Mobile Phases            | : A 5 mmol/L Ammonium acetate-Water<br>B 5 mmol/L Ammonium acetate-Methanol                                     |
| Flowrate                 | : 0.2 mL/min  |
| Time Program             | : B. Conc 5 % (0 min) → 45 % (2 min) → 75 % (12 - 13.5 min) → 5 % (13.51 - 20 min)                              |
| Column Temperature       | : 40 °C   |
| Injection Volume         | : 10 µL   |
| Probe Voltage            | : 4 kV (ESI-Positive)   |
| DL Temperature           | : 200 °C  |
| Block Heater Temperature | : 400 °C  |
| Interface Temperature    | : 200 °C  |
| Nebulizing Gas Flow      | : 2 L/min   |
| Drying Gas Flow          | : 10 L/min  |
| Heating Gas Flow         | : 10 L/min  |
| MRM Transition           | : Nereistoxin (Cartap) <i>m/z</i> 150 > 105<br>Pyraclonil <i>m/z</i> 315 > 169<br>Ferimzone <i>m/z</i> 255 > 91 |

# Application News

## No. C120

### Liquid Chromatography Mass Spectrometry

## Analysis of Glufosinate, Glyphosate, and AMPA in Drinking Water Using a Triple Quadrupole LC/MS/MS System

Glufosinate is a popular amino acid-based herbicide and glyphosate a popular foliage treatment herbicide. Glyphosate metabolizes in soil or water to form aminomethylphosphonic acid (AMPA).

In March 2015, the Japan's Ministry of Health, Labour and Welfare, Health Service Bureau, Water Supply Division issued a notification (No. 0325 Item 3 - 6) specifying the use of LC/MS/MS for water quality control inspections of glufosinate, since it is one of the pesticides designated for monitoring based on the specified target values for drinking water quality control, but no method for inspecting them has been specified so far.

### Sample Pretreatment

Method 22 involves first derivatizing samples with 9-fluorenylmethyl chloroformate (Fmoc-Cl) under basic conditions and then concentrating the samples with solid phase extraction. The structural formulas of derivatized glufosinate, glyphosate, and AMPA are shown in Fig. 1.

A flowchart of the pretreatment process is shown in Fig. 2.

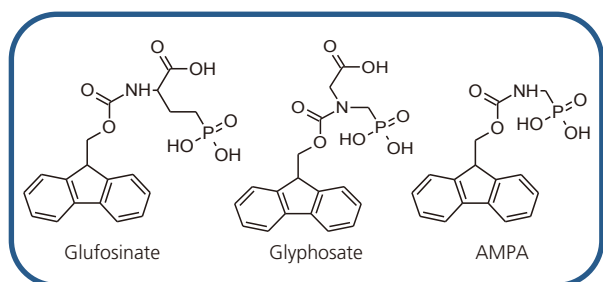
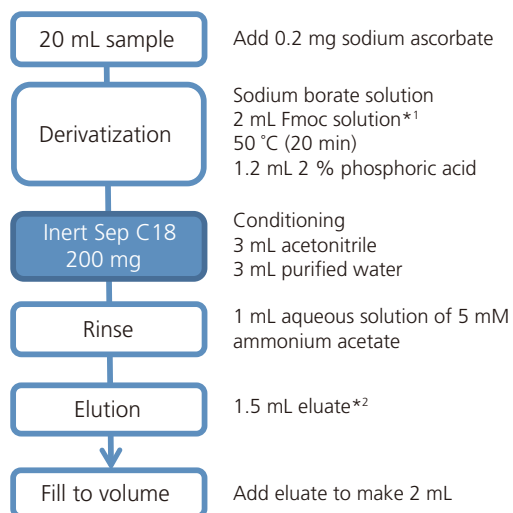


Fig. 1 Structure of Each Fmoc Derivative

The Appendix Method 22 specified for glyphosate inspection by simultaneous analysis using a "derivatization - solid phase extraction - liquid chromatograph-mass spectrometer" system, can analyze both glyphosate and AMPA at the same time, which were previously inspected using separate methods (Appendix Methods 12 and 15) involving high-performance liquid chromatography.

In this example, Appendix Method 22 is used to analyze glufosinate, glyphosate, and AMPA. In addition, by using the LCMS-8050, samples can be analyzed directly without the pretreatment process of concentrating samples by solid phase extraction.



\*1 Fmoc 1 mg/mL acetonitrile solution

\*2 Acetonitrile / 5 mmol/L ammonium acetate = 40/60

Fig. 2 Pretreatment Process

### Analyzing Glufosinate, Glyphosate, AMPA Standard Solutions (with Solid Phase Extraction)

After derivatizing the glufosinate, glyphosate, and AMPA standard mixture solution (with 0.1 µg/L each), the solution was concentrated by ten times with solid

phase extraction, and measured. The resulting MRM chromatograms are shown in Fig. 3. Analytical conditions are indicated in Table 2.

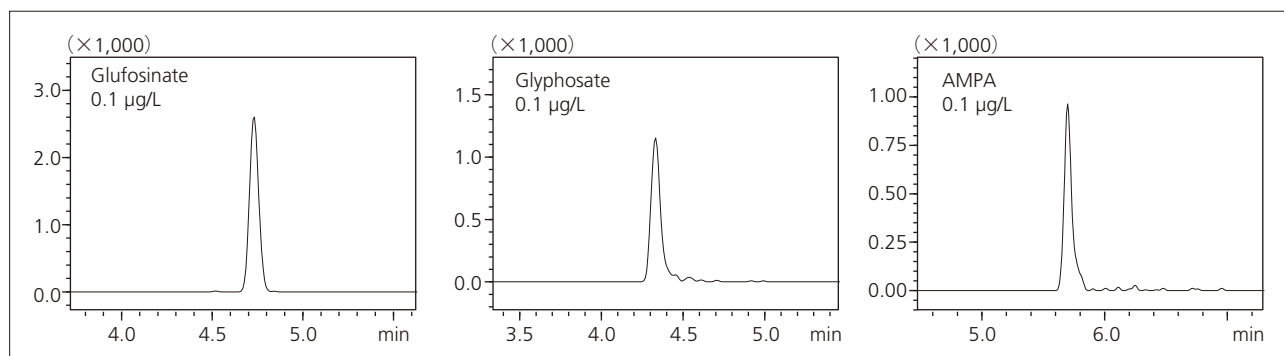


Fig. 3 MRM Chromatograms of Glufosinate, Glyphosate, AMPA Standard Solutions (with Solid Phase Extraction)

### Analyzing Glufosinate, Glyphosate, AMPA Standard Solutions by Derivatization and Direct Analysis

The glufosinate, glyphosate, and AMPA standard mixture solutions (0.1 µg/L) were also analyzed without pretreatment by solid phase extraction, after only derivatization. The resulting MRM chromatograms and area value %RSD (n = 5) are shown in Fig. 4. Even for

concentrations lower than 1/100 of the target value, results easily satisfied the criteria of less than 30 %RSD and even if the sample concentration step is skipped, high-sensitivity analysis is possible using the LCMS-8050.

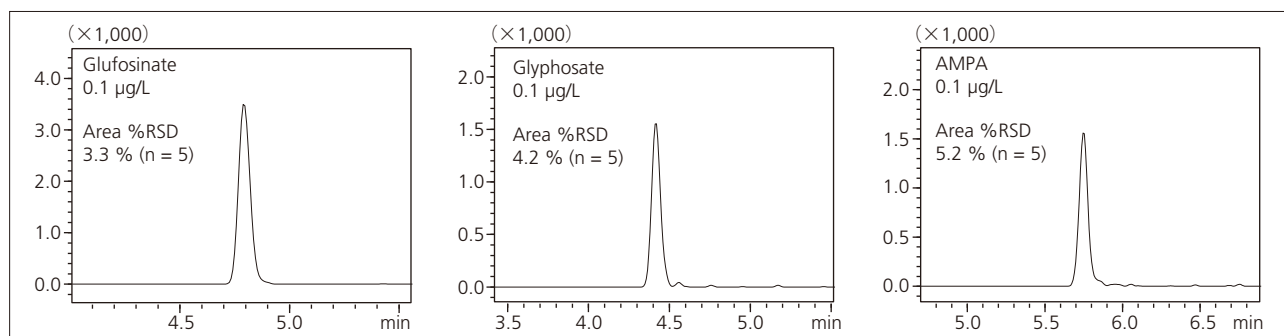


Fig. 4 MRM Chromatograms of Glufosinate, Glyphosate, AMPA Standard Solutions (Without Solid Phase Extraction)

### Spike and Recovery Test Using Drinking Water (Derivatization - Direct Analysis)

Glufosinate, glyphosate, and AMPA were added to actual public drinking water and the recovery rate was evaluated by analyzing samples with only derivatization, without solid phase extraction pretreatment. MRM chromatograms for the blank drinking water, and water spiked respectively with 0.2 µg/L glufosinate, glyphosate, and AMPA are shown in Fig. 5. The corresponding recovery rates are indicated in Table 1. Good recovery rates (accuracy) were obtained within 70 to 120 %.

Table 1 Spike and Recovery Test Results (n = 5)

|             | Recovery Rate (%) |              |
|-------------|-------------------|--------------|
|             | 0.2 µg/L Added    | 2 µg/L Added |
| Glufosinate | 96                | 99           |
| Glyphosate  | 88                | 77           |
| AMPA        | 96                | 104          |

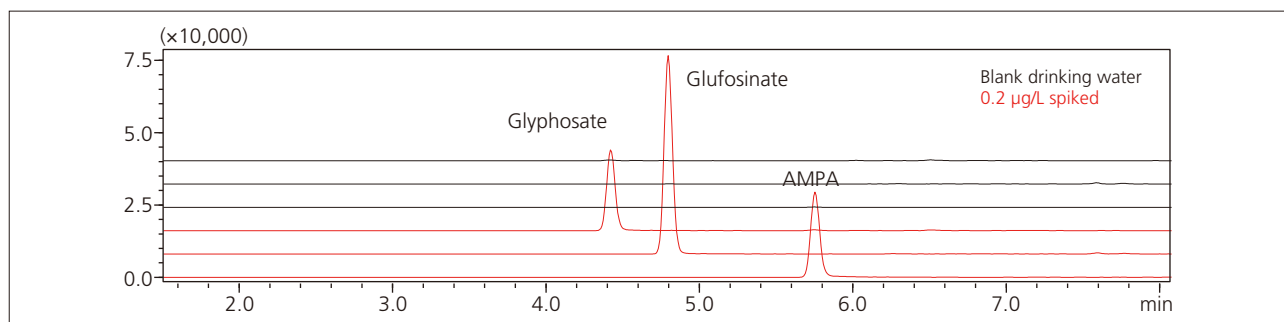


Fig. 5 MRM Chromatograms for Drinking Water (Blank) and Water Spiked with Glufosinate, Glyphosate, and AMPA (Without Solid Phase Extraction)

Table 2 Analytical Conditions

|                          |   |                                 |
|--------------------------|---|---------------------------------|
| Column                   | : Mastro C18 (100 mm L. × 2.1 mm I.D., 3 µm, Shimadzu GLC)                        |                                 |
| Mobile Phases            | : A 5 mmol/L Ammonium acetate-Water<br>: B Acetonitrile                           |                                 |
| Flowrate                 | : 0.25 mL/min   |                                 |
| Time Program             | : B.conc 5 % (0 min) → 50 % (7 min) → 95 % (7.01 - 11 min) → 5 % (11.01 - 13 min) |                                 |
| Column Temperature       | : 40 °C   |                                 |
| Injection Volume         | : 2 µL (With solid phase extraction), 20 µL (Without solid phase extraction)      |                                 |
| Probe Voltage            | : - 3 kV (ESI - Negative)   |                                 |
| DL Temperature           | : 150 °C  |                                 |
| Block Heater Temperature | : 400 °C  |                                 |
| Interface Temperature    | : 300 °C  |                                 |
| Nebulizing Gas Flow      | : 2 L/min   |                                 |
| Drying Gas Flow          | : 10 L/min  |                                 |
| Heating Gas Flow         | : 10 L/min  |                                 |
| MRM Transition           | Glufosinate <i>m/z</i> 390 > 168  | Glyphosate <i>m/z</i> 402 > 180 |
|                          | AMPA <i>m/z</i> 332 > 110   |                                 |

# Application News

## No. C129A

### Liquid Chromatography Mass Spectrometry

## Analysis of Iminoctadine, Paraquat, and Diquat in Tap Water Using Triple Quadrupole LC/MS/MS [LCMS-8050]

Iminoctadine is used as an antimicrobial agent, and paraquat and diquat are used as non-selective herbicides. By the director of Water Supply Division, Health Service Bureau, Ministry of Health, Labour and Welfare (0325 No. 3 to 6) in March 2015, a notification of "simultaneous analysis using solid-phase extraction-liquid chromatograph-mass spectrometer" (appendix method 21) was issued as a method for testing the presence of these three pesticides in tap water. This article describes an example of analysis of iminoctadine, paraquat, and diquat performed according to appendix method 21. Also described is an investigation into a simplified method that omits part of the sample pretreatment process.

### ■ Sample Pretreatment

The pretreatment process for tap water samples described in appendix method 21 involves dechlorination with sodium thiosulfate, followed by solid phase extraction in a solid phase column with divinylbenzene-N-vinylpyrrolidone copolymer with introduced carboxyl groups. The resulting eluate is then concentrated by blowing nitrogen gas, filled to volume with a mixture of acetonitrile and formic acid, then analyzed by LC/MS/MS. Fig. 1 shows a flowchart of the pretreatment process.

An important part of the pretreatment process is to prevent adsorption of sample constituents onto containers and other equipment. This is achieved by ensuring all containers and tools that come into contact with samples are made from polytetrafluoroethylene (PTFE) or polypropylene (PP) and rinsed thoroughly with purified water.

### ■ Analysis of Iminoctadine, Paraquat, and Diquat Standard Mixture

MRM chromatograms obtained from a standard mixture of iminoctadine, paraquat, and diquat (0.25 µg/L each) are shown in Fig. 2. Iminoctadine was detected at 1.5 min, paraquat at 4.9 min, and diquat at 5.7 min. The analytical conditions used are shown in Table 3.

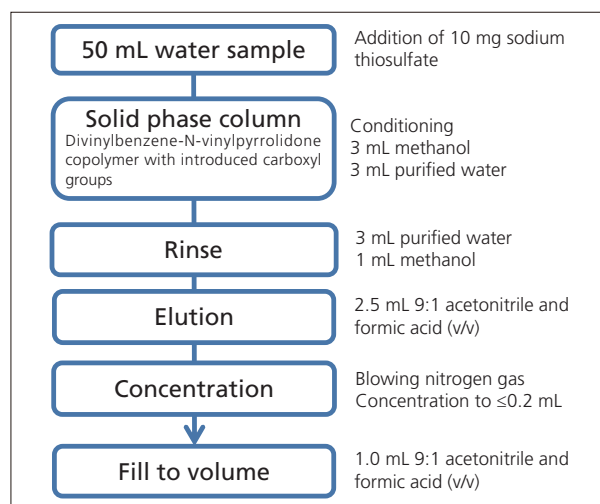


Fig. 1 Pretreatment Process

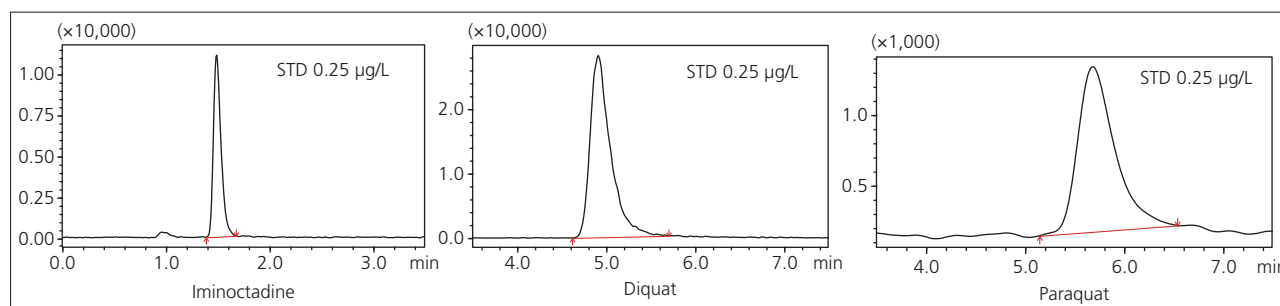


Fig. 2 MRM Chromatograms of Iminoctadine, Paraquat, and Diquat Standard Mixture

### Spike and Recovery Test Using Tap Water

Spike and recovery test using tap water was performed. Chromatograms of a tap water blank, tap water spiked with each compound at 0.05 µg/L (approximately 1/100 the target threshold concentration), and tap water spiked with each compound at 0.25 µg/L (approximately 1/20 the target threshold concentration) are shown in Fig. 3, and recovery obtained during testing is shown in Table 1. There was no marked interference by contaminants present in tap water, and results were obtained that met the accuracy target (70 % to 120 %) according to validity evaluation guidelines for tap water quality test methods.

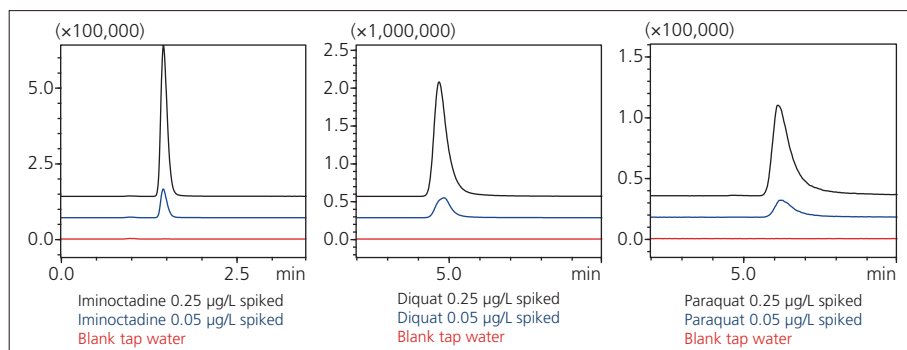


Fig. 3 MRM Chromatograms of Tap Water Blank and Tap Water Spiked with Iminoctadine, Paraquat, and Diquat

Table 1 Spike and Recovery Test Results

| Compound     | Recovery (%) |           |
|--------------|--------------|-----------|
|              | 0.05 µg/L    | 0.25 µg/L |
| Iminoctadine | 85.1         | 91.0      |
| Paraquat     | 92.9         | 94.2      |
| Diquat       | 86.8         | 91.7      |

n = 3

### Simplified Sample Pretreatment by Omitting N<sub>2</sub> Evaporation

A simplified analytical method that omits the concentration step from sample pretreatment was investigated. After performing solid phase extraction as shown in Fig. 1, eluate was made up to 5 mL with a mixture of acetonitrile and formic acid without concentration, then analyzed by LC/MS/MS. From the results obtained from the same spike and recovery test as above, Fig. 4 shows chromatograms for each tap water sample and Table 2 shows recovery. Using a simplified analytical method that omits concentration revealed no marked interference by contaminants present in tap water, and provided results that met the accuracy target according to validity evaluation guidelines.

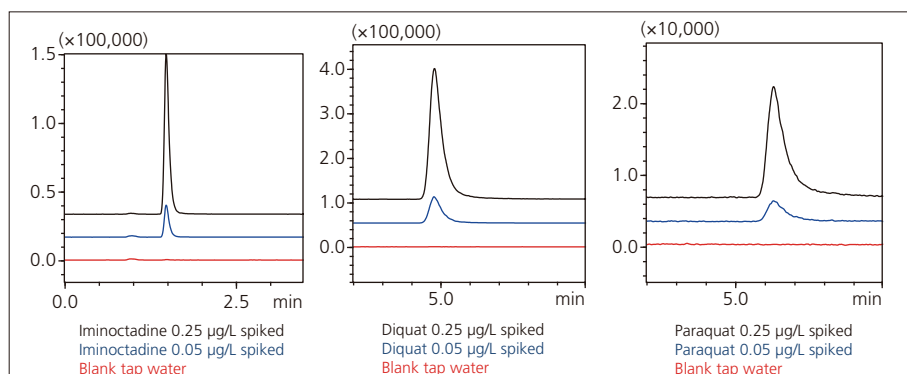


Fig. 4 MRM Chromatograms of Tap Water Samples Using a Simplified Sample Pretreatment

Table 2 Spike and Recovery Test Results Using Simplified Sample Pretreatment

| Compound     | Recovery (%) |           |
|--------------|--------------|-----------|
|              | 0.05 µg/L    | 0.25 µg/L |
| Iminoctadine | 85.2         | 85.2      |
| Paraquat     | 95.5         | 93.7      |
| Diquat       | 95.1         | 90.2      |

n = 3

Table 3 Analytical Conditions

|                          |  |
|--------------------------|--|
| Column                   | : Inertsil WP300 SIL (100 mm L. × 2.1 mm I.D., 3 µm, GL Sciences)    |
| Mobile Phases            | : 150 mmol/L Ammonium formate - water / Acetonitrile = 40 / 60 (v/v) |
| Flowrate                 | : 0.3 mL/min   |
| Column Temperature       | : 30 °C  |
| Injection Volume         | : 5 µL   |
| Probe Voltage            | : 1 kV (ESI-Positive)  |
| DL Temperature           | : 300 °C   |
| Block Heater Temperature | : 500 °C   |
| Interface Temperature    | : 400 °C   |
| Nebulizing Gas Flow      | : 3 L/min  |
| Drying Gas Flow          | : 5 L/min  |
| Heating Gas Flow         | : 15 L/min   |
| MRM Transition           | : Iminoctadine m/z 179>69 Paraquat m/z 171>77 Diquat m/z 183>157     |

First Edition: May, 2016  
Second Edition: October 2016



For Research Use Only. Not for use in diagnostic procedure.

This publication may contain references to products that are not available in your country. Please contact us to check the availability of these products in your country.

The content of this publication shall not be reproduced, altered or sold for any commercial purpose without the written approval of Shimadzu. Company names, product/service names and logos used in this publication are trademarks and trade names of Shimadzu Corporation or its affiliates, whether or not they are used with trademark symbol "TM" or "®". Third-party trademarks and trade names may be used in this publication to refer to either the entities or their products/services. Shimadzu disclaims any proprietary interest in trademarks and trade names other than its own.

The information contained herein is provided to you "as is" without warranty of any kind including without limitation warranties as to its accuracy or completeness. Shimadzu does not assume any responsibility or liability for any damage, whether direct or indirect, relating to the use of this publication. This publication is based upon the information available to Shimadzu on or before the date of publication, and subject to change without notice.

# Application News

## No. C95

### Liquid Chromatography Mass Spectrometry

## Analysis of Haloacetic Acids in Drinking Water Using Triple Quadrupole LC/MS/MS (LCMS-8050)

Haloacetic acids (HAAs), by-products of water disinfection, are formed from naturally occurring organic and inorganic materials in water which react with the disinfectants chlorine and chloramine. The Japanese Ministry of Health, Labour and Welfare has established criterion values for three of these substances, monochloroacetic acid (MCAA: 0.02 mg/L), dichloroacetic acid (DCAA: 0.04 mg/L), and trichloroacetic acid (TCAA: 0.2 mg/L). The official analytical method for measuring these haloacetic acids utilizes solvent extraction and diazomethane derivatization prior to GC/MS quantitation.

In April, 2012, this method was amended to include LC/MS/MS as an additional method for measuring haloacetic acids. These LC/MS methods, which permit

analysis of HAAs directly from water samples, offer greater sample throughput by eliminating the solvent extraction and derivatization steps required when using GC/MS. This Application News introduces the use of the LCMS-8050 triple quadrupole mass spectrometer for analysis of these HAAs in accordance with the official LC/MS methodology requirements.

In this high speed method, MCAA, DCAA, and TCAA are eluted at 3.1, 3.4, and 5.2 minutes, respectively. Fig. 1 shows an MRM chromatogram of these HAAs each at a concentration of 0.001 mg/L. The calibration curve in Fig. 2 demonstrates linearity from 0.001 to 0.1 mg/L for each substance, and peak area repeatability at 0.001 mg/L (less than 1/10 the criterion value) (n=5), which was less than 3 % (%RSD).

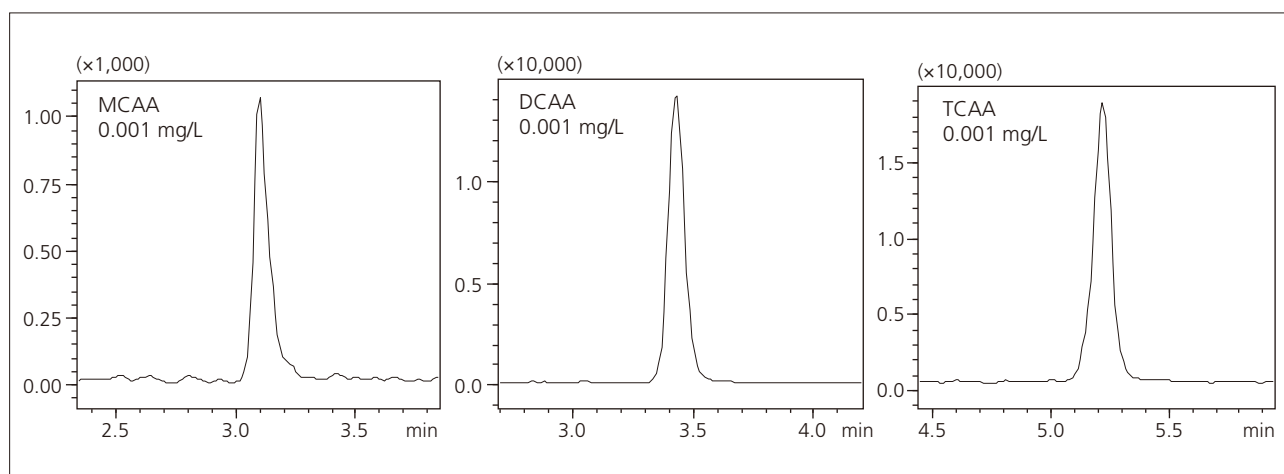


Fig. 1 MRM Chromatograms of MCAA, DCAA and TCAA (0.001 mg/L)

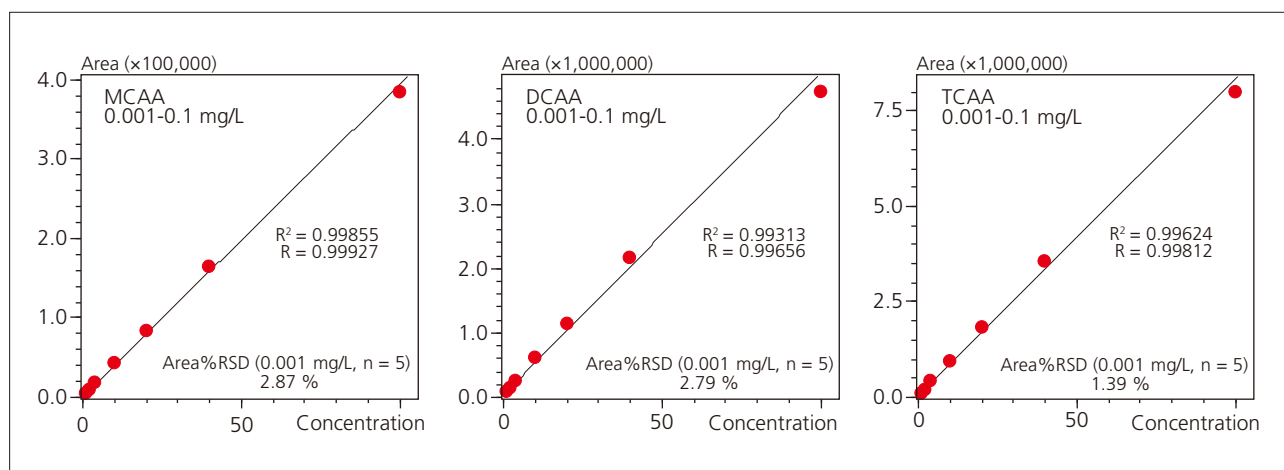


Fig. 2 Calibration Curve Linearity and Peak Area Repeatability

Quantitation and spike and recovery testing of haloacetic acids in tap water were conducted. To reduce residual chlorine in the tap water, sodium ascorbate was added at a ratio of 2 mg/100 mL. Fig. 3 shows MRM chromatograms obtained from tap water spiked with the three HAAs, each at 0.001 mg/L. The

recovery rate was determined using the average area value obtained in five repeat measurements. The official method specifies that anions present at high concentrations in the test water must be reduced "as needed." However, during these analyses, no anion contamination-related interference was observed.

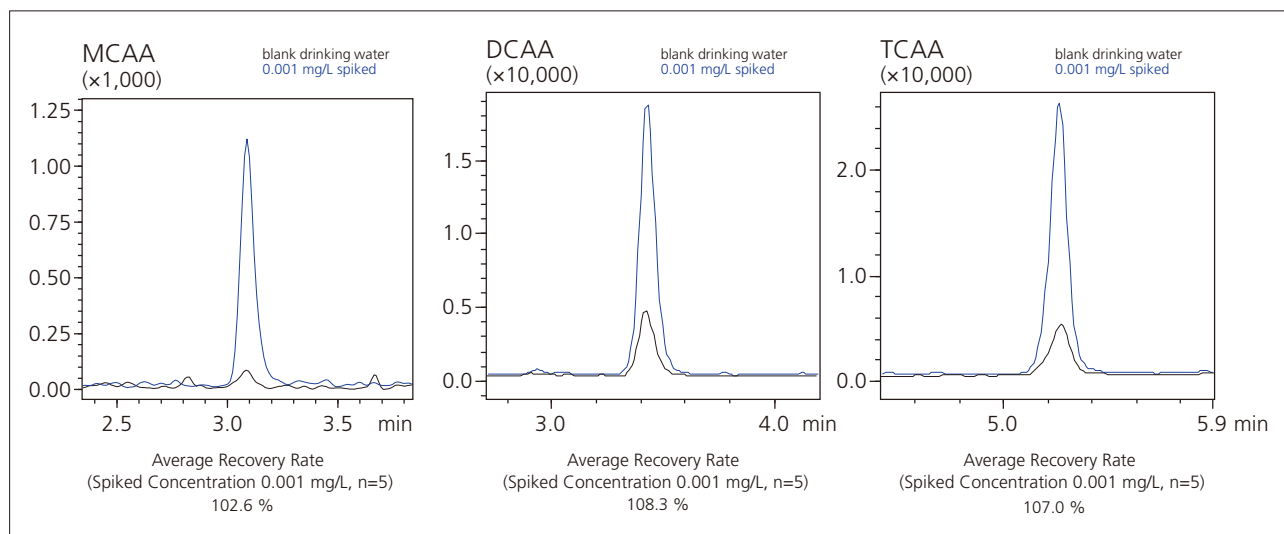


Fig. 3 MRM Chromatograms of Drinking Water Blank and Spiked with MCAA, DCAA and TCAA Respectively (0.001 mg/L)

The spike and recovery testing was conducted using tap water samples collected from four different regions (Samples 1 to 4). The results indicated no dependence on the water sampling region, with recoveries ranging

from 90 to 110 % from each collection location (see Table 1). Further, the concentrations of haloacetic acids detected were all below the criterion value.

Table 1 Quantitation and Recovery Results for Tap Water Samples

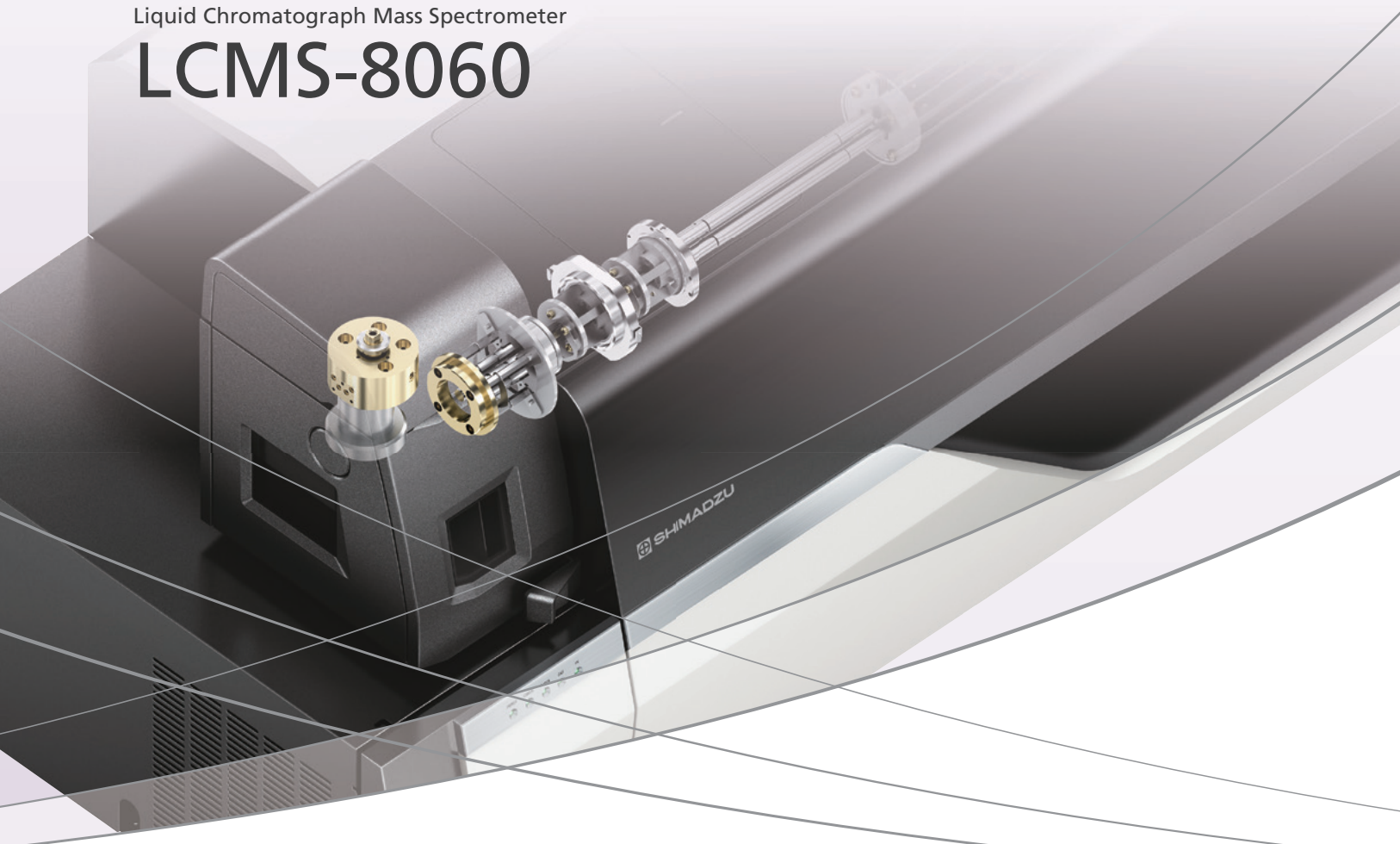
|      | Sample 1            |              | Sample 2            |              | Sample 3            |              | Sample 4            |              |
|------|---------------------|--------------|---------------------|--------------|---------------------|--------------|---------------------|--------------|
|      | Sample Conc. (mg/L) | Recovery (%) | Sample Conc. (mg/L) | Recovery (%) | Sample Conc. (mg/L) | Recovery (%) | Sample Conc. (mg/L) | Recovery (%) |
| MCAA | Tr.                 | 102.6        | 0.00076             | 103.6        | 0.00069             | 94.9         | 0.00034             | 100.4        |
| DCAA | Tr.                 | 108.3        | 0.01151             | 101.7        | 0.00742             | 102.9        | 0.00635             | 92.3         |
| TCAA | Tr.                 | 107.1        | 0.00861             | 107.2        | 0.00622             | 104.5        | 0.00452             | 102.9        |

Table 2 Analytical Conditions

|                          |   |
|--------------------------|---|
| Column                   | : CAPCELL PAK MGIII (150 mm L. × 3 mm I.D., 3 μm)   |
| Mobile Phases            | : A 0.2 % Formic acid-water<br>: B 0.2 % Formic acid-methanol   |
| Flowrate                 | : 0.5 mL/min  |
| Column Temperature       | : 50 °C   |
| Injection Volume         | : 25 μL   |
| Probe Voltage            | : -3.5 kV (ESI-negative mode)   |
| DL Temperature           | : 150 °C  |
| Block Heater Temperature | : 100 °C  |
| Interface Temperature    | : 100 °C  |
| Nebulizing Gas Flow      | : 3 L/min   |
| Drying Gas Flow          | : 5 L/min   |
| Heating Gas Flow         | : 15 L/min  |
| MRM Transition           | : MCAA; <i>m/z</i> 93.00 > 35.00<br>: DCAA; <i>m/z</i> 126.90 > 82.90<br>: TCAA; <i>m/z</i> 161.10 > 116.90 |

Liquid Chromatograph Mass Spectrometer

# LCMS-8060



## CHANGES **EVERYTHING**

The LCMS-8060 is the latest in Shimadzu's Ultra-Fast Mass Spectrometry product line, designed to deliver you the highest sensitivity and fastest analysis speed of any LCMS on the market today.

Sensitivity

### Highest Sensitivity

A newly developed UF-Qarray boosts ion intensity but suppresses noise. By improving the ion sampling device, the ion guide, and vacuum efficiency, Shimadzu has achieved an unprecedented sensitivity in LCMS.

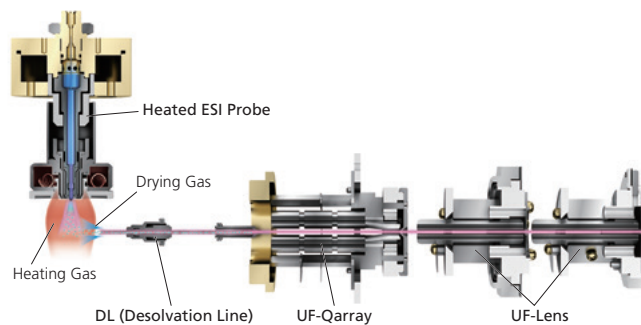
Speed

### Fastest Speed

Shimadzu's proprietary technologies allow acquisition of up to 555 MRM channels per second, ultra-fast polarity switching, and ultra-fast scanning, all with high data quality.

UFscanning: Max. 30,000 u/sec

UFswitching: 5 msec



Solutions

### Fusion of sensitivity and speed

Don't miss an exciting performance results in **next page!!**

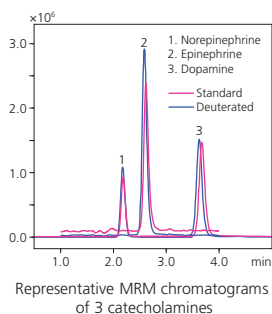




## High-Sensitivity Quantitation of Catecholamines in Plasma

Catecholamines in plasma, namely norepinephrine (NE), epinephrine (EP) and dopamine (DA), are routinely measured in the research of such diseases as hypertension or neuroblastoma. Since plasma samples contain endogenous catecholamines, it is difficult to evaluate the LLOQ in plasma matrix. Here we used deuterated catecholamine compounds as standards to estimate the LLOQ in plasma matrix, rather than as internal standards for quantitation.

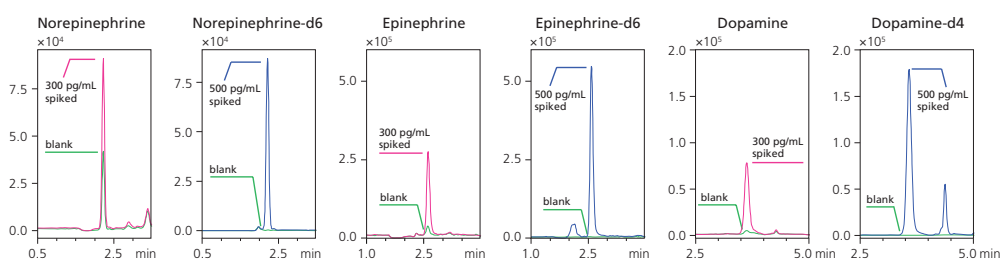
A neat standard curve was prepared by serial dilution in HPLC solvent, whereas a matrix-matched standard curve was prepared by dilution with pooled plasma sample treated with SPE. The table on the right summarizes the quantitation results, which convincingly demonstrate the capability of LCMS-8060 to detect catecholamines at ultra-high sensitivity without matrix interference.



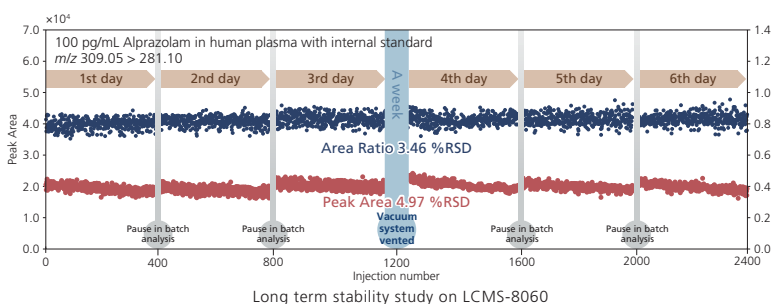
Quantitative range of neat and matrix-matched calibration curves

| Compound name                     | Neat standard curve |                             | Matrix-matched |                             |
|-----------------------------------|---------------------|-----------------------------|----------------|-----------------------------|
|                                   | Range (pg/mL)       | Linearity (r <sup>2</sup> ) | Range (pg/mL)  | Linearity (r <sup>2</sup> ) |
| Norepinephrine-d6 (158.1 > 111.1) | 2.5 – 2000          | 0.9999                      | 2.5 – 2000     | 0.9997                      |
| Epinephrine-d6 (190.1 > 172.1)    | 10 – 2000           | 0.9999                      | 10 – 2000      | 0.9994                      |
| Dopamine-d4 (158.1 > 95.1)        | 5 – 2000            | 0.9999                      | 10 – 2000      | 0.9995                      |

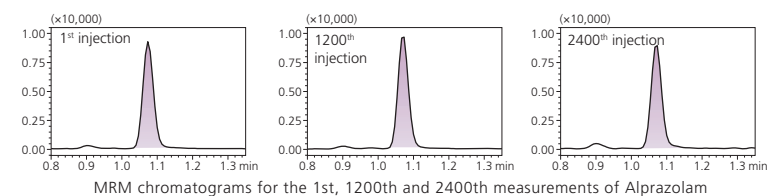
In the actual quantitation assay, deuterated catecholamines are spiked as internal standard at 500 pg/mL in plasma and analyzed by LCMS-8060. The figures on the right show the MRM chromatograms of spiked and endogenous catecholamines in plasma.



Detection of Norepinephrine, Epinephrine and Dopamine and their deuterated internal standards in plasma.



Long term stability study on LCMS-8060



MRM chromatograms for the 1st, 1200th and 2400th measurements of Alprazolam

Intraday and interday variations on LCMS-8060

| Compound             | Intraday Variation (%RSD) |         |         |         |         |         | Interday Variation (%RSD) |          |             |
|----------------------|---------------------------|---------|---------|---------|---------|---------|---------------------------|----------|-------------|
|                      | 1st day                   | 2nd day | 3rd day | 4th day | 5th day | 6th day | Days 1–3                  | Days 4–6 | 6 Day Total |
| Alprazolam           | 5.04                      | 4.94    | 5.06    | 5.38    | 4.55    | 4.83    | 3.19                      | 1.63     | 2.74        |
| Alprazolam-d5 (ISTD) | 5.04                      | 4.68    | 5.48    | 5.31    | 4.26    | 4.91    | 2.62                      | 1.89     | 2.18        |
| Area ratio           | 3.48                      | 3.11    | 3.48    | 3.44    | 3.71    | 3.54    | 1.79                      | 0.26     | 1.40        |

## Outstanding Durability

The robustness of the LCMS-8060 and modified ion optics were assessed by injecting 2400 samples of femto-gram levels of alprazolam spiked into protein-precipitated human plasma extracts over a 6 day period (over 400 samples were injected each day). The RSD of peak area response was 5% over this test period; using a deuterated internal standard (alprazolam-d5) the RSD was 3.5%. As part of the robustness test the vacuum system was vented to model a transient power failure with no effect on signal response or baseline noise level.



Shimadzu Corporation  
www.shimadzu.com/an/

For Research Use Only. Not for use in diagnostic procedures.

This publication may contain references to products that are not available in your country. Please contact us to check the availability of these products in your country.

Company names, products/service names and logos used in this publication are trademarks and trade names of Shimadzu Corporation, its subsidiaries or its affiliates, whether or not they are used with trademark symbol "TM" or "®".

Third-party trademarks and trade names may be used in this publication to refer to either the entities or their products/services, whether or not they are used with trademark symbol "TM" or "®".

Shimadzu disclaims any proprietary interest in trademarks and trade names other than its own.

The contents of this publication are provided to you "as is" without warranty of any kind, and are subject to change without notice. Shimadzu does not assume any responsibility or liability for any damage, whether direct or indirect, relating to the use of this publication.

# Application News

## No. M269

### Gas Chromatography Mass Spectrometry

## High-Sensitivity Analysis of Nonylphenol in River Water Using GC-MS/MS

Nonylphenol (NP) is used as a raw material for the production of surfactants, and as an antioxidant used to protect rubber and plastics, etc. However, in recent years, it has been specified as a substance that can cause endocrine disruption in the environment (environmental hormone).

NP, a type of alkylphenol, can theoretically exist as 211 structural isomers. Among these, the main component that is generated by the reaction of nonene (trimer of propylene) with phenol is the branched 4-nonylphenyl (4-NP).

Analysis is conducted by solid phase extraction – gas chromatography – mass spectrometry, and quantitation is conducted by (1) establishing the composition ratio of the 13 isomers included in a 4-NP standard mixture, (2) calculating the concentration of each of the detected 13 isomers using a calibration curve generated for each isomer, and (3) multiplying each isomer by the corresponding composition ratio, and calculating the sum.

However, when conducting GC/MS measurement of each isomer separately, the type of the analytical column or the instrument sensitivity may adversely affect the peak of the low-composition-ratio twelfth isomer.

Therefore, we investigated the use of a high *m/z* selectivity triple quadrupole gas chromatograph-mass spectrometer (GC-MS/MS). By optimizing the MS/MS analytical conditions, selective detection of thirteen 4-NP isomers was achieved with high sensitivity. Further, in the analysis of NP in river water, which typically contains many contaminants, analysis was possible without adversely affecting identification accuracy, even when omitting the cleanup procedure that may reduce the recovery rate.

### ■ Preparation of Standard Solution

For the nonylphenol standard mixture, we used a 4-nonylphenol standard (Code No.: 28640-96, Kanto Chemical), a 4- (3,6-dimethyl-3-heptyl) phenol-<sup>13</sup>C<sub>6</sub> standard solution (Code No.: 043-32861, Wako Pure Chemical Industries), and a p-n-nonylphenol-d4 standard (Code No.: 141-07081, Wako Pure Chemical Industries).

The standard solutions for generating a calibration curve were prepared at concentrations of 0.01, 0.05, 0.1, and 0.5 µg/mL, respectively, and for all of the calibration curve standard solution series, 4- (3,6-dimethyl-3-heptyl) phenol-<sup>13</sup>C<sub>6</sub> (surrogate) was prepared to obtain a concentration of 0.1 µg/mL, and p-n-nonylphenol-d4 (internal standard) was prepared to obtain a concentration of 0.1 µg/mL.

### ■ Analytical Conditions

This instrument system and the instrument parameters used are shown in Table 1, and the ions and transitions used for measurement are shown in Table 2. The GCMS-TQ8040, even as a single GC-MS, is an instrument that can perform high-sensitivity analysis. Therefore, we acquired data by switching between the GC-MS/MS and GC-MS modes.

**Table 1 Analytical Conditions of GC-MS and GC-MS/MS**

| Triple Quadrupole Gas Chromatograph Mass Spectrometer: GCMS-TQ8040 |  |                        |           |
|--|--|------------------------|-----------|
| GC   |  | MS                     |           |
| Column   | : Rxi-5ms (30 m × 0.25 mm I.D., 0.25 µm) <sup>*1</sup> | Ion Source Temperature | : 230 °C  |
| Glass Insert   | : Single gooseneck liner, with wool <sup>*2</sup>      | Interface Temperature  | : 280 °C  |
| Injection Port Temperature   | : 250 °C   | GC-MS                  |           |
| Injection Mode   | : Splitless  | Measurement Mode       | : Q3 SIM  |
| Sampling Time  | : 1 min  | Event Time             | : 0.3 sec |
| Sample Injection Volume  | : 2 µL   | GC-MS/MS               |           |
| Control Mode   | : Linear velocity – constant (40 cm/sec)               | Measurement Mode       | : MRM     |
| Oven Temperature   | : 50 °C (1 min) → (8 °C/min) → 300 °C (3min)           | Loop Time              | : 0.3 sec |
| High-Pressure Injection  | : 200 kPa (1.5 min)                                    |                        |           |

\*1 Code No: 13423 \*2 Code No: 567366

Table 2 Monitoring Ions of GC-MS and GC-MS/MS

| ID#   | Compound Name  | GC-MS      |          | GC-MS/MS       |                |
|-------|--|------------|----------|----------------|----------------|
|       |  | Target Ion | Ref. Ion | Target Ion     | Ref. Ion       |
| NP1   | 4-(2,4-dimethylheptane-4-yl) phenol                            | 121        | 163      | 163.00 >107.10 | 163.00 >121.10 |
| NP2   | 4-(2,4-dimethylheptane-2-yl) phenol                            | 135        | 220      | 135.00 >107.10 | 135.00 >95.10  |
| NP3   | 4-(3,6-dimethylheptane-3-yl) phenol                            | 135        | 107      | 135.00 >107.10 | 135.00 >95.10  |
| NP4   | 4-(3,5-dimethylheptane-3-yl) phenol                            | 149        | 191      | 149.00 >107.10 | 149.00 >121.10 |
| NP5   | 4-(3,5-dimethylheptane-2-yl) phenol                            | 135        | 163      | 135.00 >107.10 | 135.00 >95.10  |
| NP6   | 4-(3,5-dimethylheptane-3-yl) phenol                            | 149        | 191      | 149.00 >107.10 | 149.00 >121.10 |
| NP7   | 4-(3-ethyl-2-methylhexane-2-yl) phenol                         | 135        | 220      | 135.00 >107.10 | 135.00 >95.10  |
| NP8   | 4-(3,4-dimethylheptane-4-yl) phenol                            | 163        | 121      | 163.00 >107.10 | 163.00 >121.00 |
| NP9   | 4-(3,4-dimethylheptane-3-yl) phenol                            | 149        | 107      | 149.00 >107.10 | 149.00 >121.10 |
| NP10  | 4-(3,4-dimethylheptane-4-yl) phenol                            | 163        | 121      | 163.00 >107.10 | 163.00 >121.10 |
| NP11  | 4-(2,3-dimethylheptan-2-yl) phenol                             | 135        | 220      | 135.00 >107.10 | 135.00 >95.10  |
| NP12  | 4-(3-methyloctane-3-yl) phenol                                 | 191        | 163      | 191.00 >107.00 | 191.00 >121.20 |
| NP13  | 4-(3,4-dimethylheptane-3-yl) phenol                            | 149        | 107      | 149.00 >107.10 | 149.00 >121.10 |
| Surr. | 4-(3,6-dimethyl-3-heptyl) phenol- <sup>13</sup> C <sub>6</sub> | 155        | 113      | 155.00 >113.10 | 155.00 >127.10 |
| I.S.  | p-n-nonylphenol-d4   | 111        | 224      | 224.00 >111.10 | 224.00 >98.10  |

### Separation of 13 Nonylphenol Isomers

In the analysis of 4-nonylphenol, the composition ratio of each of the thirteen isomers must be calculated in advance using a GC-FID. We therefore conducted several analyses of a 4-NP standard mixture to investigate and determine the GC conditions which could be used to separate all of the thirteen isomers.

Factors such as the type of analytical column, linear velocity of the carrier gas, and column oven temperature program, etc. can affect the separation, and should therefore be considered.

As a result of this study, all of the thirteen isomers were separated using an Rxi-5ms analytical column (30 m × 0.25 mm I.D., 0.25 μm) and a carrier gas linear velocity of 40 cm/sec. (The analytical conditions are listed in Table 1.)

Fig. 1 shows the total ion current chromatogram obtained from measurement of a 0.5 μg/mL 4-nonylphenol standard solution using the GC-MS Q3 scan mode.

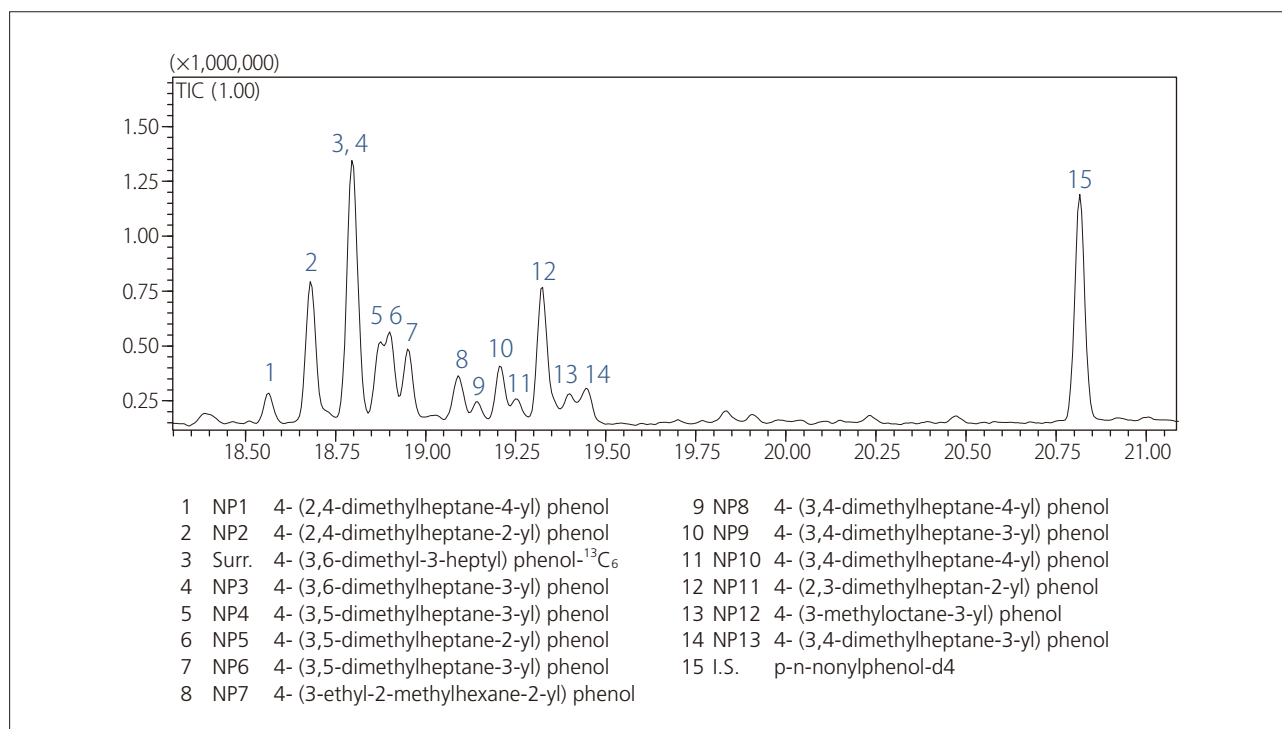


Fig. 1 Total Ion Current Chromatogram of 4-Nonylphenol Standard Solution (0.5 μg/mL)

### ■ Analysis of 4-Nonylphenol Standard Solution

The results of measurement of a 0.01 µg/mL 4-nonylphenol standard solution (calibration curve lowest concentration) using the GC-MS Q3 SIM mode and the GC-MS/MS MRM mode, respectively, are shown in Fig. 2. The 12<sup>th</sup> isomer (NP12), having a low composition ratio and low sensitivity, was difficult to detect using the Q3 SIM mode. Without any adverse background effect associated with the analytical column, a fifty-fold improvement in sensitivity was achieved using an optimized MRM mode.

To confirm the quantitative performance in MRM mode, repeat analyses were conducted to evaluate the analytical precision and calibration curve linearity (correlation coefficient: R) in the Q3 SIM mode and MRM mode. The results are shown in Table 3. The calibration curve linearity was excellent, with R=0.9999 or higher for all the components. In addition, good repeatability results of 6.01 % (NP12) or less were obtained.

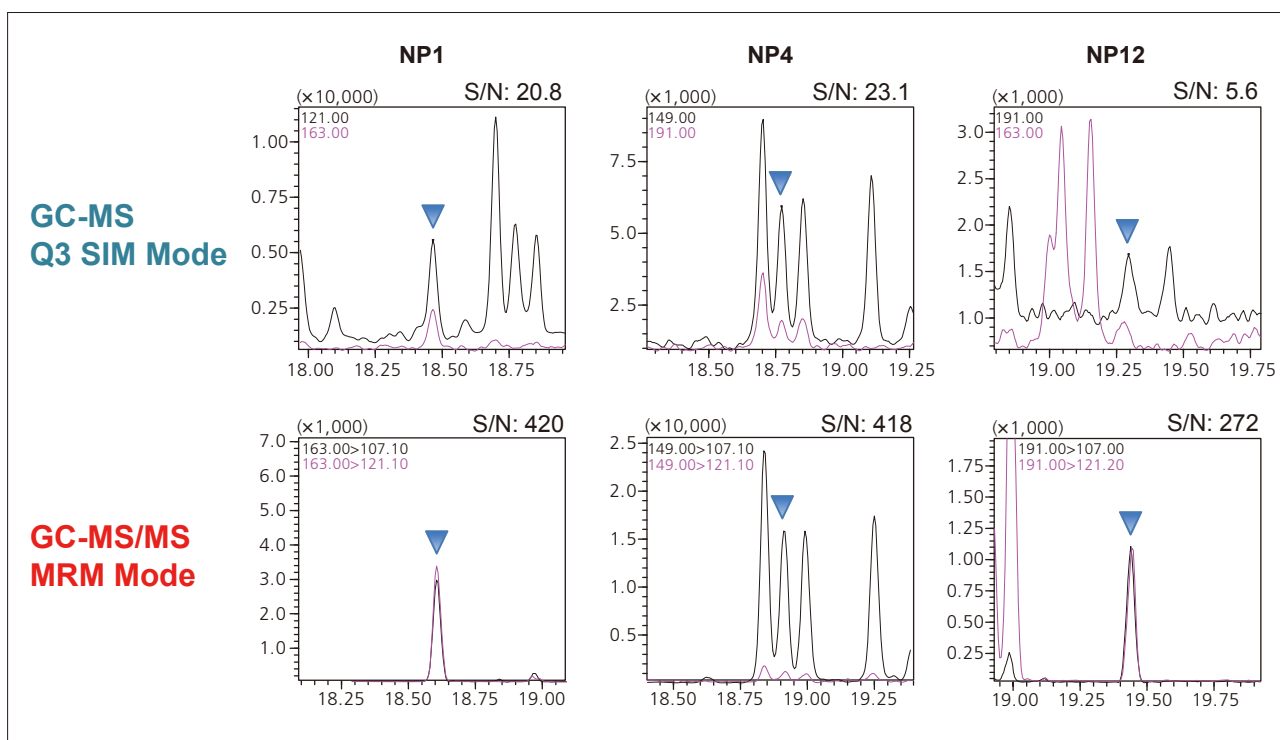


Fig. 2 SIM Chromatograms (Top) and MRM Chromatograms (Bottom) of NP1 and NP4, NP12 (0.01 µg/mL Standard Solution)

Table 3 Repeatability and Linearity of Calibration (0.01 µg/mL, n=5)

| Isomer No.  | GC-MS           |                    |             |                            | GC-MS/MS        |                    |             |                            |
|-------------|-----------------|--------------------|-------------|----------------------------|-----------------|--------------------|-------------|----------------------------|
|             | Average (µg/mL) | Standard Deviation | %RSD        | Correlation Coefficient: R | Average (µg/mL) | Standard Deviation | %RSD        | Correlation Coefficient: R |
| NP1         | 0.01005         | 0.00015            | 1.47        | 0.999999                   | 0.01037         | 0.00038            | 3.64        | 0.999997                   |
| NP2         | 0.00980         | 0.00036            | 3.69        | 0.999993                   | 0.00992         | 0.00014            | 1.42        | 0.999994                   |
| NP3         | 0.01015         | 0.00016            | 1.58        | 0.999999                   | 0.01015         | 0.00025            | 2.47        | 0.999997                   |
| NP4         | 0.01037         | 0.00016            | 1.51        | 0.999998                   | 0.01025         | 0.00024            | 2.34        | 0.999998                   |
| NP5         | 0.00980         | 0.00024            | 2.44        | 0.999999                   | 0.00994         | 0.00027            | 2.74        | 0.999999                   |
| NP6         | 0.00986         | 0.00036            | 3.62        | 0.999999                   | 0.00992         | 0.00032            | 3.23        | 0.999993                   |
| NP7         | 0.01029         | 0.00034            | 3.31        | 0.999992                   | 0.00983         | 0.00029            | 2.95        | 0.999995                   |
| NP8         | 0.01033         | 0.00034            | 3.27        | 0.999997                   | 0.00984         | 0.00021            | 2.15        | 0.999997                   |
| NP9         | 0.00941         | 0.00013            | 1.41        | 0.999992                   | 0.01014         | 0.00030            | 2.97        | 0.999995                   |
| NP10        | 0.01034         | 0.00028            | 2.75        | 0.999995                   | 0.00989         | 0.00010            | 1.05        | 0.999998                   |
| NP11        | 0.01026         | 0.00027            | 2.60        | 0.999996                   | 0.01005         | 0.00013            | 1.31        | 0.999992                   |
| <b>NP12</b> | <b>0.01019</b>  | <b>0.00077</b>     | <b>7.52</b> | <b>0.999986</b>            | <b>0.00985</b>  | <b>0.00059</b>     | <b>6.01</b> | <b>0.999954</b>            |
| NP13        | 0.01012         | 0.00025            | 2.47        | 0.999999                   | 0.01007         | 0.00035            | 3.52        | 0.999992                   |

### Analysis of 4-Nonylphenol in River Water

Fig. 3 shows the pretreatment process that was used for the analysis of river water. For the solid phase column, the Oasis HLB Plus Short Cartridge (Code No.: 186000132, Waters) was used, and the AQUAloader Twin SPL698T (Code No.: 6030-69804, GL Sciences) was used for high-pressure solid phase extraction. In this method, we omitted the post-elution cleanup procedure which uses silica gel.

The recovery rates for the surrogate standard (Surr.) added to purified water and actual river water samples are shown in Table 4. The recoveries were lower in the two river water samples than in the distilled water, but as they are in the 50 – 120 % range, the loss due to adsorption was assumed to be minimized at the pretreatment stage. Next, we spiked a pretreated river water sample with the 4-nonylphenol standard solution to obtain a final concentration of 0.05 µg/mL, and then verified the effect due to the contaminant components. As shown in Fig. 4 (upper tier), when measurement was conducted using the Q3 SIM mode, identification was difficult due to the effects of co-eluting contaminants. Fig. 4 (lower tier) shows the results of measurement of these components using the MRM mode. In this case, peak identification was easy because selective separation according to *m/z* eliminated the interference due to contaminants.

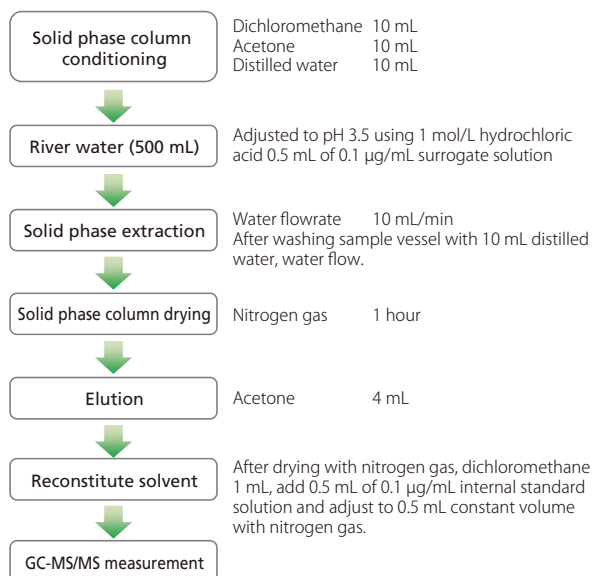


Fig. 3 River Water Sample Pretreatment Flow

Table 4 Surrogate Recovery

|              | Distilled Water | River Water 1 | River Water 2 |
|--------------|-----------------|---------------|---------------|
| Recovery (%) | 77.3            | 66.0          | 64.2          |

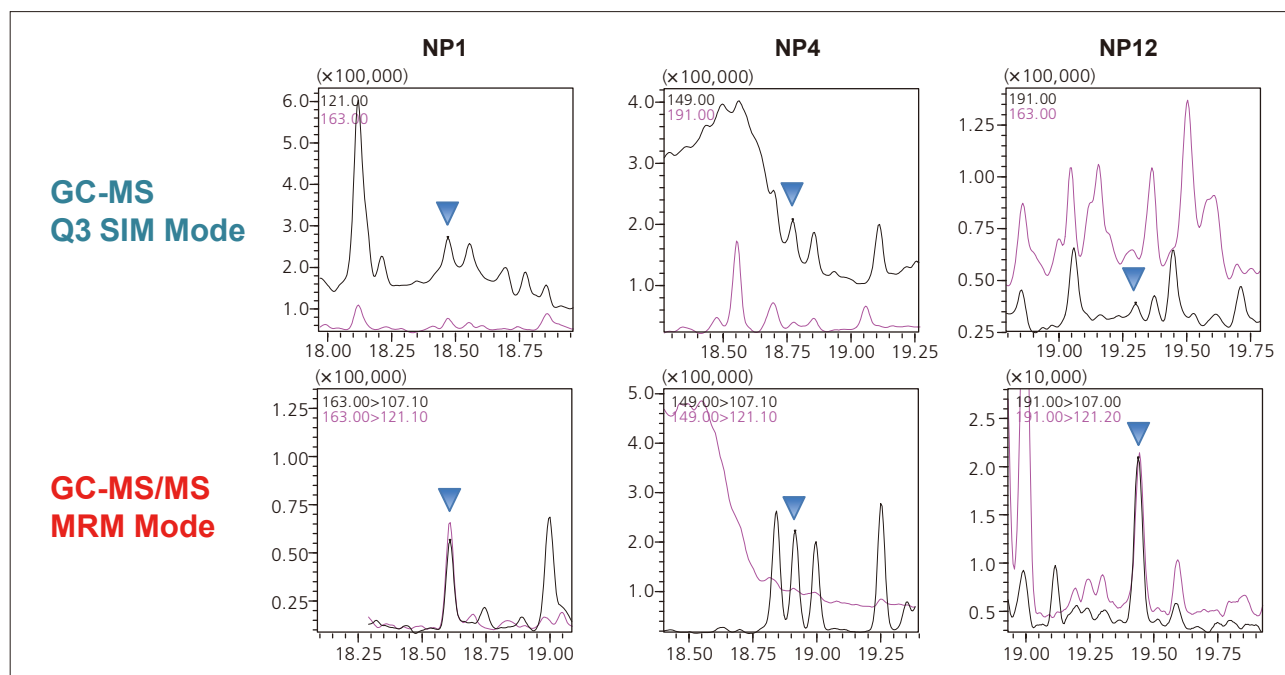


Fig. 4 SIM Chromatogram (Upper) and MRM Chromatogram (Lower) of Spiked River Water Sample

### Conclusions

The sensitivity with respect to NP12 which has been problematic in isomer-specific quantitation using conventional nonylphenol analysis of water by GC-MS was improved by a factor of 50 through MRM mode optimization using GC-MS/MS. Further, by using GC-MS/MS, peak identification, which is difficult by GC-MS due to the considerable

interference from co-eluting contaminant components, can be significantly improved with real samples with the possibility of selective separation according to *m/z*. Further, even samples containing many contaminants, such as those found in river water, can be measured using a simplified pretreatment procedure without cumbersome cleanup.

## Shimadzu Guide to US EPA Method 8260 for Analysis of Volatile Organic Compounds in Ground Water and Solid Waste

### ■ Introduction

Environmental contamination has been at the forefront of government policy and regulation since the US EPA was established in 1970. Over the years the US EPA has developed, published, and updated multiple methods for analysis of environmental pollutants, and single-quadrupole gas chromatography-mass spectrometry (GC/MS) has long been the technique of choice for determination of volatile organic contaminants (VOCs). As efforts to provide dependable analytical methods have progressed, the GC/MS instrumentation has evolved, with improvements in sensitivity, reliability, and user experience, but there haven't been many significant advancements in the overall methodology since the mid-1980s.

The VOC methods are all run using the purge-and-trap (P&T) sample introduction technique; headspace is not allowed for drinking water or wastewater compliance testing in the US. The required US EPA methods for VOCs are US EPA Methods 524.2, 524.3, and 524.4 (Drinking Water), Method 624 (Waste Water), and Method 8260 (Groundwater and Solid Waste). US EPA Method 8260 is by far the most comprehensive in terms of the number of VOCs included in the compound list, with as many as 100 or more RCRA VOCs included for testing. The method is used to determine VOCs in a variety of solid waste matrices, is applicable to nearly all types of samples, regardless of water content, and is one of the most common VOC methods used by commercial testing laboratories today.

This application note describes analytical operating conditions for analysis of US EPA Method 8260C<sup>1</sup>, Revision 3, August 2006, and includes BFB tune

parameters, calibration details, and a complete MDL and Precision and Accuracy study for almost 100 target compounds at multiple concentrations.

### ■ Experimental

This study was conducted using the Shimadzu GCMS-QP2010 SE shown in Figure 1, configured with a Restek capillary column designed specifically for analysis of VOCs by US EPA Methods mentioned above. The GC was operated in the unique Constant Linear Velocity mode to provide optimum chromatographic resolution, symmetric peak shape, and enhanced sensitivity for all compounds. A special, narrow ID inlet liner was used to minimize band broadening and retain ideal peak shape during transfer from the P&T, while still allowing high-split injections. Data were acquired in the full scan mode; quantitation and confirmation for most compounds were conducted using the quantitation and reference ion suggested in US EPA Method 8260C. Changes to quantitation and reference ions for a few selected compounds were made to improve overall sensitivity of the method.



Figure 1: Shimadzu GCMS-QP2010 SE

The EST Evolution P&T and Centurion Water/Soil Autosampler were used for the extraction, concentration, and sample introduction steps. The Evolution was configured with the optional sample heater to ensure that all samples were purged at precisely the same temperature for accuracy and precision of the data. The Centurion Water/Soil Autosampler was operated in the Water mode for this study; the Soil mode can also be used with similar results, albeit with slightly lower purge efficiency due to the needle sparging vs. frit sparging.

Each day before starting a sample sequence, the instrument was conditioned by cycling the P&T and VOCARB 3000 trap through two Bake cycles. Simultaneously, the oven, injection port, ion source, and MS interface temperatures were all raised to 220 °C for a minimum of one hour. The instrument bake-out procedure was run on all days, whether samples were analyzed or not. Complete instrument configuration and operating conditions are shown in Table 1.

**Table 1:** GC/MS and P&T Operating Conditions

|   |  |   |
|---|--|---|
| <b>Gas Chromatograph</b>                              |  | <b>GCMS-QP2010 SE</b>                                 |
| Column  | SH-RXI-624Sil MS, 30 m x 0.25 mm x 1.4 µm (Shimadzu PN 221-75962-30)   |   |
| Oven Program  | 45 °C, hold 0.1 minute<br>15 °C/minute to 220 °C, hold 3.5 minutes   |   |
| Injector  | Split mode, split ratio 40:1<br>200 °C<br>Low Volume Split Liner (Shimadzu PN 220-90784-10)  |   |
| Primary Column Carrier Gas<br>8260 Column Carrier Gas | Helium<br>Constant linear velocity mode, 36.2 cm/sec<br>Total Flow 44.1 mL/min, Column Flow = 1.0 mL/min<br>Purge Flow 3.0 mL/min  |   |
| Interface Temperature                                 | 180 °C   |   |
| <b>Mass Spectrometer</b>                              |  | <b>GCMS-QP2010 SE</b>                                 |
| Ion Source Temperature                                | 185 °C   |   |
| MS Operating Mode                                     | Full scan mode, m/z 35-270<br>Event time = 0.25 second/scan<br>Solvent cut time = 0.7 minute<br>Detector voltage set relative to tune + 0.1 kV<br>Threshold = 100<br>NOTE: Scan rate was adjusted to provide a minimum of 10-12 spectra across all GC peaks for optimum quantitation |   |
| <b>Purge-and-Trap Concentrator</b>                    |  | <b>EST Encon Evolution with Centurion Autosampler</b> |
| Sample Volume   | 5 mL   |   |
| Sample Temperature at Purge                           | 40 °C  |   |
| Trap  | VOCARB 3000  |   |
| Purge Flow Rate                                       | Helium, 40 mL/minute for 11 minutes  |   |
| Dry Purge   | Helium, 40 mL/minute for 1 minute  |   |
| Desorb  | 250 °C for 0.5 minute  |   |
| Bake  | 260 °C for 8.0 minutes   |   |
| <b>Analysis Times</b>                                 |  |   |
| GC Run Time   | 16 minutes   |   |
| System Cycle Time                                     | 26 minutes   |   |

## ■ Results and Discussion

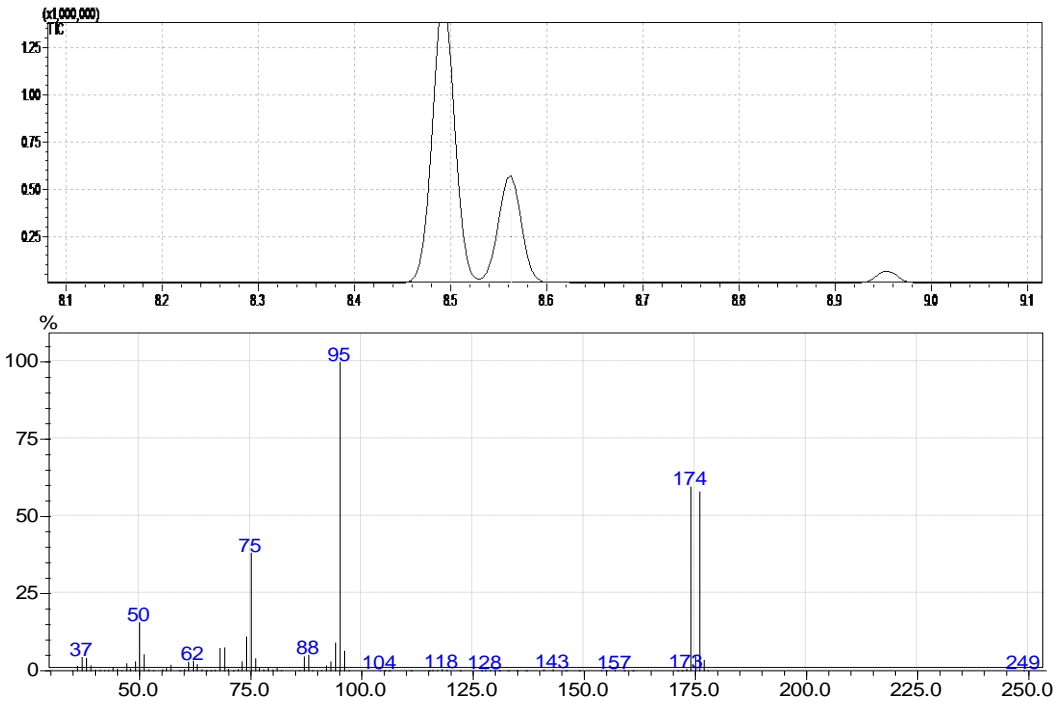
### *BFB Tune Results*

At the beginning of the project the GCMS-QP2010 SE was tuned<sup>2</sup> to meet the US EPA Method 8260C requirements. Each day prior to running any samples, and at intervals of no longer than 12-hours during long sequences, an aliquot of the 4-bromofluorobenzene (BFB) was purged and analyzed using the method conditions shown in Table 1. The BFB spectra were evaluated using the

US EPA Method 8260C criteria. Since BFB was one of the Surrogate Standards added to all samples, the BFB spectrum was available for evaluation for every run. A representative example of a BFB chromatogram and spectrum are shown in Figure 2.

Table 2 lists the BFB results as compared to the method criteria from four selected analyses of BFB during one of the extended sequences. The BFB spectra met all method criteria for all samples evaluated throughout the project. The tune

remained stable throughout the project, approximately 6 weeks, and the GCMS-QP2010 SE instrument did not require re-tuning at any time during the analysis period.



| Mass (m/z) | Relative Abundance Criteria | Result | Status |
|------------|-----------------------------|--------|--------|
| 50         | 15 to 40% of 95             | 15.8   | Pass   |
| 75         | 30 to 60% of 95             | 40.1   | Pass   |
| 95         | Base Peak, 100%             | 100    | Pass   |
| 96         | 5 to 9% of 95               | 6.8    | Pass   |
| 173        | < 2% of 174                 | 0.45   | Pass   |
| 174        | > 50% of 95                 | 80.8   | Pass   |
| 175        | 5 to 9% of 174              | 6.7    | Pass   |
| 176        | > 95% but < 101% of 174     | 100.6  | Pass   |
| 177        | 5 to 9% of 176              | 5.9    | Pass   |

Figure 2: Typical Results from BFB Tune Evaluation Using US EPA Method 8260C Criteria

Table 2: Evaluation of BFB Spectra from 4 Different Runs across a Long Sequence, Compared to US EPA Method 8260C Criteria

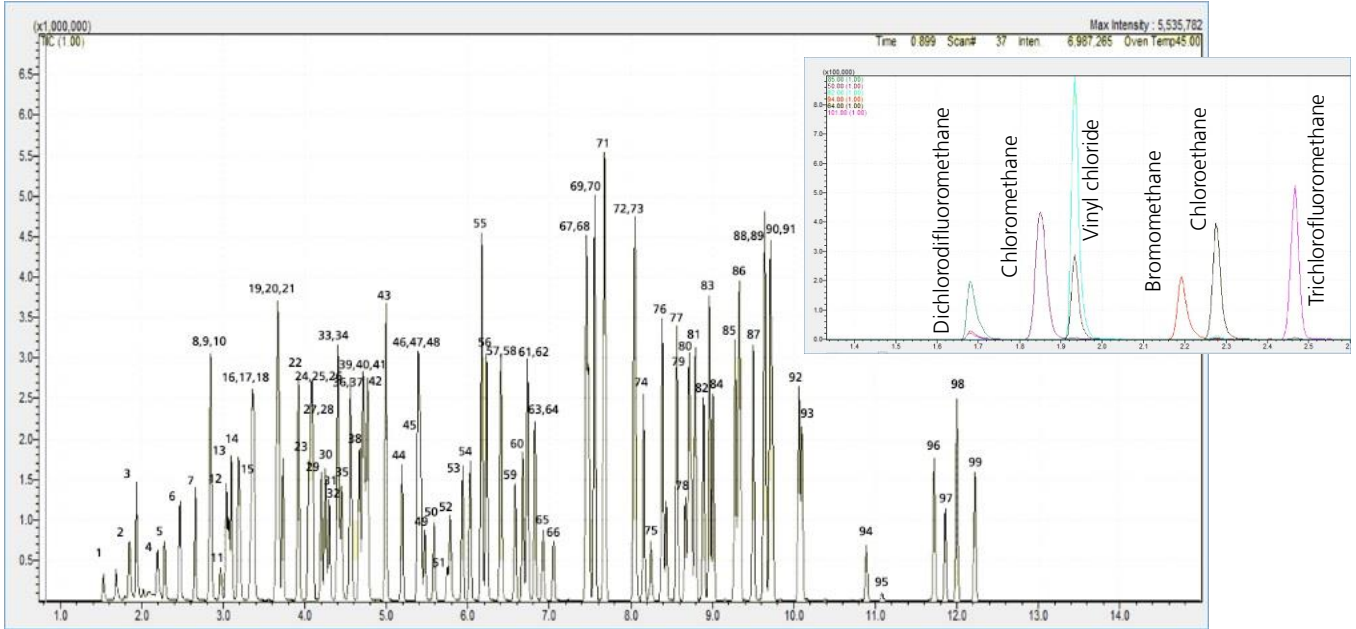
| m/z | Spectrum Check Criteria            | Result |        | Result |        | Result |        | Result |        |
|-----|------------------------------------|--------|--------|--------|--------|--------|--------|--------|--------|
|     |                                    | BFB    | Status | BFB    | Status | BFB    | Status | BFB    | Status |
| 50  | 15 to 40% of mass 95               | 15.2   | Pass   | 15.2   | Pass   | 15.5   | Pass   | 16.1   | Pass   |
| 75  | 30 to 60% of mass 95               | 38.1   | Pass   | 37.4   | Pass   | 35.9   | Pass   | 34.1   | Pass   |
| 95  | Base Peak, 100% Relative Abundance | 100    | Pass   | 100    | Pass   | 100    | Pass   | 100    | Pass   |
| 96  | 5 to 9% of mass 95                 | 6.8    | Pass   | 6.9    | Pass   | 6.7    | Pass   | 6.6    | Pass   |
| 173 | < 2% of mass 174                   | 0.48   | Pass   | 0.40   | Pass   | 0.54   | Pass   | 0.47   | Pass   |
| 174 | > 50% of mass 95                   | 79.9   | Pass   | 81.9   | Pass   | 81.5   | Pass   | 70.7   | Pass   |
| 175 | 5 to 9% of mass 174                | 7.1    | Pass   | 7.1    | Pass   | 6.9    | Pass   | 6.7    | Pass   |
| 176 | > 95% but < 101% of mass 174       | 98.8   | Pass   | 99.8   | Pass   | 95.6   | Pass   | 98.9   | Pass   |
| 177 | 5 to 9% of mass 176                | 6.4    | Pass   | 6.5    | Pass   | 6.3    | Pass   | 6.0    | Pass   |



### Initial Calibration and Continuing Calibration Verification

A series of nine initial calibration standards across the range of 0.5 to 200 µg/L (parts-per-billion, ppb) was prepared. The four internal standards (IS) were held constant at 50 µg/L, and the three surrogate standards (SURRE) were held constant at 50 µg/L in

all samples analyzed. A total ion chromatogram (TIC) from a mid-point standard is shown in Figure 3, along with an expanded view of the chromatography of the early-eluting gases.



**Figure 3:** Total Ion Chromatogram from a mid-point Calibration Standard and EICP of the Six Light Gases. Peak numbers correspond to compound names shown in Tables 3, 4, and 5.

The calibration curve was evaluated two ways: using correlation coefficient ( $R^2$ ) from a linear regression, and using the percent relative standard deviation (% RSD) of the calculated response factors (RF) for each data point in the curve. The calibration curve was evaluated across three different concentration ranges (0.5 to 50 µg/L, 0.5 to 100 µg/L, and 0.5 to 200 µg/L) to accommodate any type of VOC project, and passed the US EPA Method 8260C criteria (RF % RSD < 20%) for all except two compounds over the three concentration ranges.

Continuing calibration verifications (CCV) standards were analyzed periodically throughout the project, as specified in US EPA Method 8260C. The CCV concentrations varied throughout the project to monitor the entire calibration range, and were calculated based on one of the calibration curves. Recoveries were typical for most US EPA VOC methods (80 to 120%). Complete statistical results for the initial calibration curve and three representative CCVs analyzed during the project are shown in Table 3.

**Table 3:** Statistical Results from the Initial Calibration and Three Representative CCVs

| Peak # | Compound Name               | 7-Point Calibration |        |         | 8-Point Calibration |        |         | 9-Point Calibration |        |         | CCV #1                   | CCV #2  | CCV #3  |
|--------|-----------------------------|---------------------|--------|---------|---------------------|--------|---------|---------------------|--------|---------|--------------------------|---------|---------|
|        |                             | 0.5 to 50 µg/L      |        |         | 0.5 to 100 µg/L     |        |         | 0.5 to 200 µg/L     |        |         | Calculated Concentration |         |         |
|        |                             | R <sup>2</sup>      | Avg RF | RF %RSD | R <sup>2</sup>      | Avg RF | RF %RSD | R <sup>2</sup>      | Avg RF | RF %RSD | 5 µg/L                   | 10 µg/L | 20 µg/L |
| 1      | Dichlorodifluoromethane     | 1.000               | 0.16   | 11.5    | 1.000               | 0.19   | 11.5    | 1.000               | 0.16   | 11.0    | 5.4                      | 9.9     | 19.5    |
| 2      | Chloromethane               | 1.000               | 0.36   | 6.9     | 1.000               | 0.40   | 7.1     | 1.000               | 0.36   | 7.0     | 5.9                      | 11.0    | 19.7    |
| 3      | Vinyl Chloride              | 1.000               | 0.49   | 8.0     | 1.000               | 0.53   | 8.6     | 1.000               | 0.47   | 8.7     | 5.7                      | 10.7    | 19.9    |
| 4      | Bromomethane                | 0.999               | 0.22   | 39.0    | 1.000               | 0.31   | 40.2    | 1.000               | 0.16   | 15.1    | 6.6                      | 12.6    | 19.6    |
| 5      | Chloroethane                | 1.000               | 0.30   | 11.1    | 1.000               | 0.35   | 11.0    | 0.999               | 0.30   | 10.3    | 5.5                      | 10.4    | 18.5    |
| 6      | Trichlorofluoromethane      | 1.000               | 0.29   | 9.6     | 1.000               | 0.35   | 10.2    | 1.000               | 0.28   | 10.1    | 5.6                      | 10.5    | 19.5    |
| 7      | Diethylether                | 1.000               | 0.29   | 8.7     | 1.000               | 0.30   | 8.3     | 0.999               | 0.29   | 8.0     | 5.5                      | 11.1    | 19.1    |
| 8      | 1,1,2-Trichlorofluoroethane | 1.000               | 0.23   | 9.1     | 1.000               | 0.27   | 9.3     | 0.998               | 0.23   | 8.7     | 5.3                      | 10.3    | 18.8    |
| 9      | 1,1-Dichloroethene          | 1.000               | 0.21   | 8.1     | 1.000               | 0.24   | 7.7     | 0.998               | 0.22   | 7.9     | 5.3                      | 10.3    | 18.6    |
| 10     | Acetone                     | 1.000               | 0.25   | 59.2    | 1.000               | 0.24   | 60.0    | 0.999               | 0.17   | 20.8    | 6.3                      | 11.3    | 14.2    |
| 11     | Iodomethane                 | 0.995               | 0.12   | 30.2    | 0.999               | 0.10   | 33.7    | 0.999               | 0.13   | 35.0    | 3.9                      | 9.4     | 21.0    |
| 12     | Carbon Disulfide            | 1.000               | 0.61   | 20.0    | 0.999               | 0.86   | 18.9    | 0.997               | 0.58   | 10.8    | 5.3                      | 9.9     | 17.2    |
| 13     | Acetonitrile                | 1.000               | 0.20   | 11.7    | 1.000               | 0.40   | 9.8     | 0.999               | 0.40   | 7.5     | 5.6                      | 11.2    | 18.1    |
| 14     | Methylene Chloride          | 1.000               | 0.23   | 33.7    | 1.000               | 0.38   | 33.4    | 0.996               | 0.19   | 11.9    | 5.1                      | 9.3     | 16.3    |
| 15     | Tert Butyl Alcohol          | 0.999               | 0.09   | 12.7    | 1.000               | 0.11   | 12.6    | 0.999               | 0.09   | 11.8    | 28.8                     | 51.3    | 98.0    |
| 16     | Acrylonitrile               | 1.000               | 0.20   | 11.7    | 1.000               | 0.23   | 11.8    | 0.999               | 0.20   | 11.1    | 5.8                      | 10.8    | 19.6    |
| 17     | MTBE                        | 1.000               | 0.72   | 6.8     | 1.000               | 0.79   | 6.3     | 0.998               | 0.73   | 7.4     | 5.6                      | 10.8    | 18.9    |
| 18     | trans-1,2-Dichloroethene    | 1.000               | 0.23   | 11.8    | 1.000               | 0.28   | 11.2    | 0.998               | 0.23   | 10.6    | 5.4                      | 10.3    | 18.6    |
| 19     | Vinyl Acetate               | 0.999               | 0.91   | 8.5     | 0.999               | 1.00   | 9.3     | 0.999               | 0.90   | 8.7     | 4.7                      | 8.3     | 17.6    |
| 20     | Isopropylether              | 1.000               | 0.78   | 5.5     | 0.999               | 0.84   | 5.1     | 0.999               | 0.79   | 5.5     | 5.6                      | 10.9    | 19.3    |
| 21     | 1,1-Dichloroethane          | 1.000               | 0.50   | 5.5     | 1.000               | 0.53   | 5.1     | 0.997               | 0.52   | 7.6     | 5.5                      | 10.4    | 18.9    |
| 22     | Ethyl Tert Butyl Ether      | 1.000               | 0.93   | 6.7     | 1.000               | 1.01   | 6.3     | 1.000               | 0.93   | 6.1     | 5.7                      | 11.3    | 19.7    |
| 23     | 2-Butanone                  | 1.000               | 1.16   | 61.1    | 1.000               | 2.57   | 62.4    | 0.998               | 1.05   | 61.9    | 6.2                      | 10.8    | 12.8    |
| 24     | Ethyl Acetate               | 0.999               | 0.06   | 21.8    | 1.000               | 0.09   | 21.1    | 0.998               | 0.06   | 19.7    | 5.3                      | 10.6    | 17.3    |
| 25     | cis-1,2-Dichloroethene      | 1.000               | 0.24   | 7.8     | 1.000               | 0.26   | 7.3     | 0.997               | 0.25   | 8.0     | 5.5                      | 10.5    | 19.1    |
| 26     | Propionitrile               | 0.999               | 0.09   | 7.1     | 1.000               | 0.09   | 7.1     | 0.998               | 0.09   | 9.9     | 5.4                      | 10.3    | 19.5    |
| 27     | 2,2-Dichloropropane         | 1.000               | 0.25   | 10.5    | 1.000               | 0.29   | 10.0    | 0.997               | 0.25   | 10.0    | 4.6                      | 9.0     | 15.5    |
| 28     | Methyl Acrylate             | 1.000               | 0.44   | 7.0     | 1.000               | 0.46   | 6.8     | 0.999               | 0.44   | 6.7     | 5.8                      | 11.0    | 19.4    |
| 29     | Methacrylonitrile           | 1.000               | 0.24   | 9.7     | 1.000               | 0.27   | 9.3     | 0.999               | 0.24   | 8.8     | 5.7                      | 10.9    | 19.3    |
| 30     | Bromochloromethane          | 0.999               | 0.14   | 18.3    | 1.000               | 0.18   | 17.8    | 0.998               | 0.14   | 16.7    | 5.8                      | 10.7    | 18.4    |
| 31     | THF                         | 1.000               | 0.21   | 37.1    | 1.000               | 0.35   | 36.6    | 0.998               | 0.17   | 9.4     | 6.2                      | 11.1    | 16.3    |
| 32     | Chloroform                  | 1.000               | 0.27   | 8.9     | 1.000               | 0.31   | 8.7     | 0.998               | 0.27   | 8.3     | 5.5                      | 10.6    | 18.6    |
| 33     | Pentafluorobenzene (IS)     | ISTD                | ISTD   | ISTD    | ISTD                | ISTD   | ISTD    | ISTD                | ISTD   | ISTD    | 50.0                     | 50.0    | 50.0    |
| 34     | Dibromofluoromethane (SURR) | NA                  | 0.44   | 1.4     | NA                  | 0.44   | 1.5     | NA                  | 0.44   | 2.0     | 50.7                     | 50.4    | 51.0    |
| 35     | 1,1,1-Trichloroethane       | 1.000               | 0.25   | 5.6     | 1.000               | 0.25   | 6.6     | 0.999               | 0.25   | 5.0     | 5.5                      | 10.4    | 18.3    |
| 36     | 1,1-Dichloropropene         | 0.910               | 0.22   | 7.8     | 0.999               | 0.26   | 7.4     | 0.994               | 0.26   | 11.0    | 5.3                      | 10.1    | 18.2    |
| 37     | Carbon Tetrachloride        | 1.000               | 0.21   | 4.0     | 1.000               | 0.22   | 3.8     | 0.997               | 0.22   | 7.4     | 5.2                      | 10.2    | 19.1    |
| 38     | Methyl Acetate              | 1.000               | 0.59   | 8.8     | 1.000               | 0.67   | 8.6     | 0.998               | 0.59   | 8.2     | 5.7                      | 10.9    | 19.1    |
| 39     | Benzene                     | 1.000               | 0.80   | 8.8     | 0.999               | 0.93   | 8.2     | 0.999               | 0.81   | 8.2     | 5.5                      | 10.5    | 18.5    |
| 40     | 1,2-Dichloroethane          | 1.000               | 0.17   | 8.4     | 1.000               | 0.18   | 8.7     | 1.000               | 0.17   | 8.3     | 5.6                      | 10.9    | 18.9    |
| 41     | Isobutyl Alcohol            | 1.000               | 0.58   | 9.0     | 1.000               | 0.57   | 8.4     | 0.998               | 0.58   | 7.8     | 3.9                      | 11.0    | 19.3    |
| 42     | Tert Amyl Methyl Ether      | 1.000               | 0.66   | 6.0     | 0.999               | 0.70   | 5.7     | 0.997               | 0.68   | 8.3     | 5.5                      | 10.8    | 19.0    |
| 43     | 1,4-Difluorobenzene (IS)    | ISTD                | ISTD   | ISTD    | ISTD                | ISTD   | ISTD    | ISTD                | ISTD   | ISTD    | 50.0                     | 50.0    | 50.0    |
| 44     | Trichloroethene             | 1.000               | 0.12   | 9.1     | 0.998               | 0.14   | 8.5     | 0.995               | 0.12   | 11.4    | 5.3                      | 11.0    | 18.4    |
| 45     | Methyl Methacrylate         | 0.999               | 0.14   | 13.1    | 0.999               | 0.16   | 12.1    | 0.995               | 0.14   | 13.3    | 5.2                      | 10.1    | 17.8    |
| 46     | 1,2-Dichloropropane         | 1.000               | 0.14   | 6.2     | 0.999               | 0.15   | 6.0     | 0.996               | 0.15   | 9.5     | 5.3                      | 10.6    | 18.2    |
| 47     | Propyl Acetate              | 1.000               | 0.28   | 8.2     | 1.000               | 0.29   | 7.6     | 0.998               | 0.28   | 7.8     | 5.5                      | 10.8    | 19.2    |
| 48     | 1,4-Dioxane                 | 0.999               | 0.00   | 26.6    | 0.999               | 0.00   | 24.2    | 0.999               | 0.00   | 10.4    | 5.9                      | 22.7    | 41.7    |
| 49     | Dibromomethane              | 1.000               | 0.07   | 10.3    | 1.000               | 0.08   | 9.9     | 0.998               | 0.07   | 9.4     | 5.6                      | 10.6    | 18.2    |
| 50     | Bromodichloromethane        | 1.000               | 0.10   | 9.5     | 1.000               | 0.08   | 8.8     | 0.999               | 0.10   | 8.5     | 5.5                      | 11.1    | 19.2    |
| 51     | 2-Nitropropane              | 0.997               | 0.04   | 9.2     | 0.999               | -      | 9.6     | 0.999               | 0.04   | 11.4    | 4.8                      | 9.3     | 17.9    |
| 52     | 2-Chloroethylvinylether     | 1.000               | 0.19   | 4.9     | 1.000               | 0.19   | 5.4     | 0.997               | 0.19   | 6.0     | 5.7                      | 11.1    | 18.3    |
| 53     | cis-1,3-Dichloropropane     | 1.000               | 0.16   | 8.2     | 0.999               | 0.17   | 7.6     | 0.998               | 0.16   | 8.4     | 5.3                      | 10.5    | 18.3    |
| 54     | 4-Methyl-2-pentanone        | 1.000               | 0.24   | 7.3     | 1.000               | 0.25   | 7.0     | 0.999               | 0.24   | 6.8     | 5.6                      | 11.1    | 19.3    |
| 55     | Toluene-d8 (SURR)           | NA                  | 0.96   | 1.3     | NA                  | 0.94   | 1.2     | NA                  | 0.96   | 1.4     | 50.3                     | 50.7    | 50.3    |
| 56     | Toluene                     | 1.000               | 0.30   | 12.2    | 1.000               | 0.35   | 11.9    | 0.998               | 0.30   | 11.3    | 5.2                      | 10.1    | 17.7    |
| 57     | trans-1,3-Dichloropropene   | 1.000               | 0.14   | 4.9     | 0.999               | 0.14   | 5.2     | 0.996               | 0.14   | 9.7     | 5.1                      | 10.4    | 18.1    |
| 58     | Ethyl Methacrylate          | 0.999               | 0.21   | 11.5    | 0.999               | 0.25   | 10.7    | 0.995               | 0.21   | 12.7    | 5.0                      | 10.2    | 17.8    |
| 59     | 1,1,2-Trichloroethane       | 1.000               | 0.11   | 8.3     | 1.000               | 0.11   | 8.3     | 0.999               | 0.11   | 7.8     | 5.6                      | 11.0    | 19.0    |
| 60     | Tetrachloroethane           | 0.998               | 0.11   | 7.3     | 0.988               | 0.12   | 13.9    | 0.993               | 0.12   | 21.4    | 7.3                      | 15.0    | 23.2    |
| 61     | 1,3-Dichloropropane         | 0.999               | 0.16   | 6.2     | 0.999               | 0.17   | 5.9     | 0.995               | 0.17   | 10.1    | 5.4                      | 10.5    | 18.1    |
| 62     | 2-Hexanone                  | 0.999               | 0.19   | 8.2     | 1.000               | 0.21   | 7.6     | 0.998               | 0.19   | 8.4     | 5.6                      | 10.7    | 18.9    |
| 63     | Isopropyl Acetate           | 0.999               | 0.06   | 8.1     | 1.000               | 0.06   | 7.6     | 0.998               | 0.06   | 7.8     | 5.4                      | 10.7    | 18.9    |
| 64     | Butyl Acetate               | 0.999               | 0.17   | 10.2    | 1.000               | 0.19   | 10.0    | 0.999               | 0.17   | 9.4     | 5.5                      | 10.8    | 18.9    |

Table 3: continued

| Peak # | Compound Name               | 7-Point Calibration |        |         | 8-Point Calibration |        |         | 9-Point Calibration |        |         | CCV #1                   | CCV #2  | CCV #3  |
|--------|-----------------------------|---------------------|--------|---------|---------------------|--------|---------|---------------------|--------|---------|--------------------------|---------|---------|
|        |                             | 0.5 to 50 µg/L      |        |         | 0.5 to 100 µg/L     |        |         | 0.5 to 200 µg/L     |        |         | Calculated Concentration |         |         |
|        |                             | R <sup>2</sup>      | Avg RF | RF %RSD | R <sup>2</sup>      | Avg RF | RF %RSD | R <sup>2</sup>      | Avg RF | RF %RSD | 5 µg/L                   | 10 µg/L | 20 µg/L |
| 65     | Dibromochloromethane        | 0.999               | 0.08   | 4.9     | 0.999               | 0.09   | 5.0     | 0.998               | 0.09   | 8.1     | 5.1                      | 10.7    | 19.0    |
| 66     | 1,2-Dibromoethane           | 1.000               | 0.12   | 7.4     | 1.000               | 0.12   | 7.1     | 0.999               | 0.12   | 6.8     | 5.7                      | 11.4    | 19.1    |
| 67     | Chlorobenzene-d5 (IS)       | ISTD                | ISTD   | ISTD    | ISTD                | ISTD   | ISTD    | ISTD                | ISTD   | ISTD    | 50.0                     | 50.0    | 50.0    |
| 68     | Chlorobenzene               | 1.000               | 0.47   | 8.3     | 1.000               | 0.52   | 7.7     | 0.999               | 0.47   | 7.3     | 5.3                      | 10.5    | 18.9    |
| 69     | 1,1,1,2-Tetrachloroethane   | 0.999               | 0.12   | 17.9    | 0.998               | 0.15   | 16.6    | 0.996               | 0.11   | 13.6    | 5.1                      | 10.3    | 18.6    |
| 70     | Ethylbenzene                | 1.000               | 0.60   | 8.2     | 0.999               | 0.66   | 7.7     | 1.000               | 0.59   | 7.8     | 5.4                      | 10.6    | 18.8    |
| 71     | Xylene (m&p)                | 1.000               | 0.48   | 8.1     | 0.999               | 0.52   | 7.6     | 0.993               | 0.46   | 10.8    | 10.9                     | 21.5    | 38.3    |
| 72     | Xylene (o)                  | 1.000               | 0.47   | 8.2     | 0.999               | 0.50   | 7.7     | 0.999               | 0.47   | 7.3     | 5.4                      | 10.6    | 18.6    |
| 73     | Styrene                     | 1.000               | 0.52   | 5.9     | 0.999               | 0.55   | 5.6     | 1.000               | 0.52   | 5.2     | 5.3                      | 10.8    | 19.1    |
| 74     | n-Amyl Acetate              | 1.000               | 0.29   | 8.7     | 1.000               | 0.30   | 8.3     | 0.999               | 0.29   | 7.8     | 5.6                      | 11.1    | 19.1    |
| 75     | Bromoform                   | 0.999               | 0.08   | 11.4    | 0.999               | 0.09   | 10.6    | 0.999               | 0.08   | 10.6    | 4.9                      | 9.8     | 18.3    |
| 76     | Isopropylbenzene            | 1.000               | 2.01   | 9.2     | 0.999               | 2.25   | 8.6     | 0.998               | 1.97   | 9.6     | 5.7                      | 10.8    | 18.8    |
| 77     | BFB(SURR)                   | NA                  | 1.02   | 1.3     | NA                  | 1.03   | 1.4     | NA                  | 1.02   | 1.5     | 51.2                     | 51.1    | 49.9    |
| 78     | 1,1,2,2-Tetrachloroethane   | 0.999               | 0.44   | 12.1    | 1.000               | 0.52   | 12.2    | 0.999               | 0.44   | 11.5    | 5.2                      | 9.9     | 18.0    |
| 79     | Bromobenzene                | 0.999               | 0.41   | 9.5     | 0.999               | 0.46   | 9.1     | 0.997               | 0.41   | 9.2     | 5.4                      | 10.4    | 17.5    |
| 80     | 1,2,3-Trichloropropane      | 1.000               | 0.63   | 7.1     | 0.998               | 0.63   | 7.0     | 0.995               | 0.65   | 11.7    | 5.4                      | 10.4    | 17.6    |
| 81     | n-Propylbenzene             | 0.999               | 1.77   | 8.7     | 0.999               | 1.95   | 8.5     | 1.000               | 1.74   | 8.8     | 5.6                      | 10.9    | 18.7    |
| 82     | 2-Chlorotoluene             | 0.999               | 0.39   | 7.9     | 0.998               | -      | 7.3     | 0.994               | 0.40   | 12.2    | 5.3                      | 10.2    | 17.4    |
| 83     | 1,3,5-Trimethylbenzene      | 1.000               | 1.64   | 8.4     | 0.999               | 1.81   | 7.8     | 1.000               | 1.62   | 7.7     | 5.6                      | 10.8    | 18.5    |
| 84     | 4-Chlorotoluene             | 0.999               | 0.40   | 9.5     | 0.997               | 0.46   | 8.9     | 0.994               | 0.42   | 12.9    | 5.2                      | 10.1    | 17.6    |
| 85     | tert-Butylbenzene           | 1.000               | 1.36   | 19.3    | 0.998               | 1.81   | 18.0    | 0.998               | 1.36   | 16.9    | 5.3                      | 10.2    | 17.8    |
| 86     | 1,2,4-Trimethylbenzene      | 1.000               | 1.64   | 7.9     | 0.999               | 1.81   | 7.4     | 1.000               | 1.62   | 7.3     | 5.6                      | 10.8    | 18.5    |
| 87     | sec-Butylbenzene            | 1.000               | 0.37   | 11.5    | 0.998               | 0.40   | 9.6     | 0.998               | 0.36   | 9.6     | 5.3                      | 10.3    | 17.6    |
| 88     | 1,3-Dichlorobenzene         | 1.000               | 0.72   | 8.4     | 0.998               | 0.79   | 7.7     | 0.995               | 0.74   | 10.2    | 5.3                      | 10.5    | 17.9    |
| 89     | Isopropyltoluene            | 1.000               | 1.47   | 6.3     | 0.997               | 1.66   | 8.1     | 0.999               | 1.52   | 8.2     | 5.3                      | 10.2    | 17.9    |
| 90     | 1,4-Dichlorobenzene-d4 (IS) | ISTD                | ISTD   | ISTD    | ISTD                | ISTD   | ISTD    | ISTD                | ISTD   | ISTD    | 50.0                     | 50.0    | 50.0    |
| 91     | 1,4-Dichlorobenzene         | 1.000               | 0.76   | 11.8    | 0.999               | 0.88   | 11.3    | 0.997               | 0.76   | 10.9    | 5.4                      | 10.5    | 17.5    |
| 92     | n-Butylbenzene              | 1.000               | 1.07   | 9.2     | 0.999               | 1.22   | 8.9     | 0.998               | 1.07   | 8.7     | 5.5                      | 10.6    | 18.2    |
| 93     | 1,2-Dichlorobenzene         | 1.000               | 0.68   | 10.9    | 0.999               | 0.80   | 10.3    | 0.998               | 0.68   | 10.0    | 5.4                      | 10.6    | 18.0    |
| 94     | 1,2-Dibromo-3-chloropropane | 0.999               | 0.15   | 8.9     | 1.000               | 0.15   | 8.8     | 0.999               | 0.14   | 8.3     | 5.2                      | 10.8    | 18.8    |
| 95     | Nitrobenzene                | 0.998               | 0.01   | 10.3    | 0.999               | 0.01   | 10.0    | 0.992               | 0.01   | 21.8    | 4.6                      | 9.7     | 15.5    |
| 96     | 1,2,4-Trichlorobenzene      | 1.000               | 0.35   | 8.0     | 0.998               | 0.40   | 7.6     | 0.996               | 0.37   | 10.7    | 5.4                      | 10.4    | 17.3    |
| 97     | Hexachlorobutadiene         | 0.999               | 0.14   | 7.5     | 1.000               | 0.14   | 7.5     | 0.999               | 0.14   | 7.1     | 5.7                      | 10.7    | 18.1    |
| 98     | Naphthalene                 | 0.999               | 1.48   | 13.4    | 0.999               | 1.81   | 12.4    | 0.999               | 1.49   | 11.7    | 5.3                      | 10.5    | 17.6    |
| 99     | 1,2,3-Trichlorobenzene      | 0.999               | 0.34   | 12.9    | 0.999               | 0.42   | 11.9    | 0.997               | 0.35   | 12.4    | 5.2                      | 10.1    | 17.1    |

*Method Detection Limit Study*

A Method Detection Limit (MDL) study<sup>3</sup> was conducted by analyzing 8 replicate aliquots each of the 0.5 and 1.0 µg/L standards. The MDLs were calculated using the procedure outlined in the

Federal Register, and all MDLs easily met the criteria. The MDL study results at both concentrations are shown in table 4.

**Table 4:** Method Detection Limit (MDL) Study Results

| Peak # | Compound Name               | 0.5 µg/L<br>n = 8 |      | 1.0 µg/L<br>n = 8 |      |
|--------|-----------------------------|-------------------|------|-------------------|------|
|        |                             | % RSD             | MDL  | % RSD             | MDL  |
| 1      | Dichlorodifluoromethane     | 5.4               | 0.10 | 9.1               | 0.35 |
| 2      | Chloromethane               | 7.1               | 0.15 | 6.2               | 0.29 |
| 3      | Vinyl Chloride              | 5.2               | 0.10 | 7.2               | 0.34 |
| 4      | Bromomethane                | 12.3              | 0.35 | 5.0               | 0.27 |
| 5      | Chloroethane                | 5.9               | 0.11 | 12.9              | 0.50 |
| 6      | Trichlorofluoromethane      | 5.6               | 0.11 | 8.6               | 0.39 |
| 7      | Diethylether                | 4.6               | 0.09 | 4.1               | 0.17 |
| 8      | 1,1,2-Trichlorofluoroethane | 4.6               | 0.08 | 6.4               | 0.26 |
| 9      | 1,1-Dichloroethene          | 6.0               | 0.11 | 7.6               | 0.32 |
| 10     | Acetone                     | 16.9              | 0.61 | 5.9               | 0.29 |
| 11     | Iodomethane                 | 18.7              | 0.28 | 11.5              | 0.34 |
| 12     | Carbon Disulfide            | 13.4              | 0.31 | 2.6               | 0.10 |
| 13     | Acetonitrile                | 12.0              | 0.29 | 6.1               | 0.26 |
| 14     | Methylene Chloride          | 3.1               | 0.09 | 4.7               | 0.22 |
| 15     | Tert Butyl Alcohol          | 14.0              | 1.41 | 7.3               | 1.43 |
| 16     | Acrylonitrile               | 8.1               | 0.17 | 7.1               | 0.32 |
| 17     | MTBE                        | 3.7               | 0.06 | 5.2               | 0.19 |
| 18     | trans-1,2-Dichloroethene    | 8.6               | 0.16 | 4.4               | 0.19 |
| 19     | Vinyl Acetate               | 12.4              | 0.21 | 11.4              | 0.43 |
| 20     | Isopropylether              | 3.8               | 0.07 | 6.3               | 0.26 |
| 21     | 1,1-Dichloroethane          | 5.9               | 0.10 | 4.6               | 0.17 |
| 22     | Ethyl Tert Butyl Ether      | 3.5               | 0.06 | 4.3               | 0.18 |
| 23     | 2-Butanone                  | 17.4              | 0.67 | 2.9               | 0.14 |
| 24     | Ethyl Acetate               | 23.0              | 0.46 | 12.6              | 0.56 |
| 25     | cis-1,2-Dichloroethene      | 8.2               | 0.16 | 6.4               | 0.27 |
| 26     | Propionitrile               | 7.9               | 0.16 | 26.2              | 1.09 |
| 27     | 2,2-Dichloropropane         | 8.2               | 0.12 | 5.1               | 0.14 |
| 28     | Methyl Acrylate             | 5.4               | 0.10 | 5.9               | 0.25 |
| 29     | Methacrylonitrile           | 4.2               | 0.08 | 4.3               | 0.17 |
| 30     | Bromochloromethane          | 6.0               | 0.13 | 5.6               | 0.24 |
| 31     | THF                         | 5.8               | 0.16 | 5.0               | 0.23 |
| 32     | Chloroform                  | 6.4               | 0.12 | 5.1               | 0.21 |
| 33     | Pentafluorobenzene (IS)     | NA                | NA   | NA                | NA   |
| 34     | Dibromofluoromethane (SURR) | 1.7               | 2.55 | 1.6               | 2.29 |
| 35     | 1,1,1-Trichloroethane       | 4.3               | 0.08 | 5.1               | 0.21 |
| 36     | 1,1-Dichloropropene         | 8.8               | 0.16 | 5.5               | 0.20 |
| 37     | Carbon Tetrachloride        | 8.2               | 0.12 | 8.5               | 0.29 |
| 38     | Methyl Acetate              | 4.8               | 0.09 | 4.2               | 0.16 |
| 39     | Benzene                     | 4.3               | 0.08 | 4.4               | 0.17 |
| 40     | 1,2-Dichloroethane          | 3.1               | 0.06 | 5.3               | 0.25 |
| 41     | Isobutyl Alcohol            | 3.4               | 0.06 | 5.0               | 0.20 |
| 42     | Tert Amyl Methyl Ether      | 5.9               | 0.10 | 4.3               | 0.16 |
| 43     | 1,4-Diflourobenzene (IS)    | NA                | NA   | NA                | NA   |
| 44     | Trichloroethene             | 6.2               | 0.12 | 8.7               | 0.37 |
| 45     | Methyl Methacrylate         | 9.8               | 0.19 | 7.0               | 0.29 |
| 46     | 1,2-Dichloropropane         | 10.4              | 0.18 | 4.1               | 0.16 |
| 47     | Propyl Acetate              | 3.4               | 0.06 | 4.2               | 0.18 |
| 48     | 1,4-Dioxane                 | 21.3              | 0.80 | 36.6              | 2.70 |
| 49     | Dibromomethane              | 5.9               | 0.12 | 6.9               | 0.30 |
| 50     | Bromodichloromethane        | 5.9               | 0.11 | 7.1               | 0.31 |
| 51     | 2-Nitropropane              | 14.3              | 0.25 | 22.0              | 0.74 |
| 52     | 2-Chloroethylvinylether     | 9.9               | 0.17 | 6.7               | 0.24 |
| 53     | cis-1,3-Dichloropropane     | 3.6               | 0.06 | 4.9               | 0.18 |

Table 4: continued

| Peak # | Compound Name               | 0.5 µg/L<br>n = 8 |      | 1.0 µg/L<br>n = 8 |      |
|--------|-----------------------------|-------------------|------|-------------------|------|
|        |                             | % RSD             | MDL  | % RSD             | MDL  |
| 54     | 4-Methyl-2-pentanone        | 3.1               | 0.06 | 5.0               | 0.22 |
| 55     | Toluene-d8 (SURR)           | 1.3               | 2.08 | 1.6               | 2.58 |
| 56     | Toluene                     | 2.8               | 0.06 | 5.6               | 0.26 |
| 57     | trans-1,3-Dichloropropene   | 7.7               | 0.14 | 4.4               | 0.17 |
| 58     | Ethyl Methacrylate          | 4.6               | 0.08 | 5.6               | 0.22 |
| 59     | 1,1,2-Trichloroethane       | 10.1              | 0.19 | 4.7               | 0.22 |
| 60     | Tetrachloroethane           | 18.0              | 0.34 | 26.4              | 1.08 |
| 61     | 1,3-Dichloropropane         | 2.8               | 0.05 | 3.1               | 0.13 |
| 62     | 2-Hexanone                  | 4.5               | 0.09 | 5.6               | 0.24 |
| 63     | Isopropyl Acetate           | 5.0               | 0.09 | 10.9              | 0.43 |
| 64     | Butyl Acetate               | 4.7               | 0.09 | 4.5               | 0.19 |
| 65     | Dibromochloromethane        | 6.1               | 0.10 | 4.7               | 0.18 |
| 66     | 1,2-Dibromoethane           | 4.2               | 0.08 | 5.9               | 0.27 |
| 67     | Chlorobenzene-d5 (IS)       | NA                | NA   | NA                | NA   |
| 68     | Chlorobenzene               | 4.7               | 0.09 | 5.4               | 0.23 |
| 69     | 1,1,1,2-Tetrachloroethane   | 11.7              | 0.26 | 15.9              | 0.70 |
| 70     | Ethylbenzene                | 3.0               | 0.06 | 6.8               | 0.31 |
| 71     | Xylene (m&p)                | 4.3               | 0.17 | 5.7               | 0.53 |
| 72     | Xylene (o)                  | 3.7               | 0.07 | 6.3               | 0.29 |
| 73     | Styrene                     | 3.7               | 0.07 | 3.2               | 0.14 |
| 74     | n-Amyl Acetate              | 7.1               | 0.13 | 4.9               | 0.21 |
| 75     | Bromoform                   | 14.7              | 0.26 | 5.6               | 0.22 |
| 76     | Isopropylbenzene            | 4.4               | 0.08 | 3.6               | 0.14 |
| 77     | BFB(SURR)                   | 1.6               | 2.41 | 0.6               | 0.92 |
| 78     | 1,1,2,2-Tetrachloroethane   | 5.1               | 0.09 | 6.4               | 0.25 |
| 79     | Bromobenzene                | 7.5               | 0.14 | 4.3               | 0.18 |
| 80     | 1,2,3-Trichloropropane      | 29.2              | 0.44 | 31.2              | 1.07 |
| 81     | n-Propylbenzene             | 4.7               | 0.09 | 4.5               | 0.18 |
| 82     | 2-Chlorotoluene             | 8.5               | 0.15 | 4.5               | 0.16 |
| 83     | 1,3,5-Trimethylbenzene      | 4.3               | 0.08 | 3.6               | 0.14 |
| 84     | 4-Chlorotoluene             | 5.4               | 0.10 | 5.0               | 0.18 |
| 85     | tert-Butylbenzene           | 6.1               | 0.11 | 5.3               | 0.19 |
| 86     | 1,2,4-Trimethylbenzene      | 6.5               | 0.12 | 3.1               | 0.12 |
| 87     | sec-Butylbenzene            | 7.5               | 0.13 | 4.7               | 0.18 |
| 88     | 1,3-Dichlorobenzene         | 6.2               | 0.12 | 3.5               | 0.14 |
| 89     | Isopropyltoluene            | 7.8               | 0.13 | 2.8               | 0.10 |
| 90     | 1,4-Dichlorobenzene-d4 (IS) | NA                | NA   | NA                | NA   |
| 91     | 1,4-Dichlorobenzene         | 9.5               | 0.19 | 3.2               | 0.14 |
| 92     | n-Butylbenzene              | 10.5              | 0.20 | 5.3               | 0.21 |
| 93     | 1,2-Dichlorobenzene         | 8.1               | 0.15 | 5.9               | 0.25 |
| 94     | 1,2-Dibromo-3-chloropropane | 9.0               | 0.15 | 7.2               | 0.26 |
| 95     | Nitrobenzene                | 27.6              | 0.47 | 26.6              | 0.79 |
| 96     | 1,2,4-Trichlorobenzene      | 15.5              | 0.31 | 1.9               | 0.07 |
| 97     | Hexachlorobutadiene         | 16.5              | 0.34 | 5.6               | 0.25 |
| 98     | Naphthalene                 | 15.2              | 0.29 | 3.2               | 0.12 |
| 99     | 1,2,3-Trichlorobenzene      | 14.8              | 0.27 | 4.6               | 0.17 |

*Precision and Accuracy Study*

A Precision and Accuracy (P&A) study was conducted to gauge the expected performance of the method at different concentration levels. Eight replicate aliquots each of the 10 and 50 µg/L standards were analyzed using the operating

conditions shown above. Table 5 lists the detailed results of the P&A study, reporting the average concentration reported for each compound (n = 8), the percent recovery, and the %RSD for all compounds at both concentration levels.

**Table 5:** Precision and Accuracy (P&A) Study Results

| Peak # | Compound Name               | Precision and Accuracy at 10 µg/L<br>n = 8 |          |       | Precision and Accuracy at 50 µg/L<br>n = 8 |          |       |
|--------|-----------------------------|--|----------|-------|--|----------|-------|
|        |                             | Mean Concentration (µg/L)                  | Recovery | % RSD | Mean Concentration (µg/L)                  | Recovery | % RSD |
| 1      | Dichlorodifluoromethane     | 7.8  | 78%      | 8.4   | 53.1                                       | 106%     | 13.6  |
| 2      | Chloromethane               | 9.2  | 92%      | 8.3   | 58.1                                       | 116%     | 8.2   |
| 3      | Vinyl Chloride              | 9.3  | 93%      | 8.5   | 59.9                                       | 120%     | 6.4   |
| 4      | Bromomethane                | 10.6                                       | 106%     | 9.2   | 66.9                                       | 134%     | 6.8   |
| 5      | Chloroethane                | 9.3  | 93%      | 4.1   | 56.9                                       | 114%     | 15.5  |
| 6      | Trichlorofluoromethane      | 8.8  | 88%      | 10.6  | 59.9                                       | 120%     | 6.3   |
| 7      | Diethylether                | 9.5  | 95%      | 1.5   | 55.1                                       | 110%     | 14.1  |
| 8      | 1,1,2-Trichlorofluoroethane | 9.7  | 97%      | 6.0   | 55.4                                       | 111%     | 8.4   |
| 9      | 1,1-Dichloroethene          | 9.9  | 99%      | 4.6   | 54.7                                       | 109%     | 11.7  |
| 10     | Acetone                     | 8.3  | 83%      | 9.1   | 59.6                                       | 119%     | 12.7  |
| 11     | Iodomethane                 | 8.7  | 87%      | 10.4  | 54.4                                       | 109%     | 13.7  |
| 12     | Carbon Disulfide            | 10.8                                       | 108%     | 16.2  | 55.7                                       | 111%     | 19.8  |
| 13     | Acetonitrile                | 10.6                                       | 106%     | 24.2  | 56.9                                       | 114%     | 12.1  |
| 14     | Methylene Chloride          | 9.8  | 98%      | 4.9   | 56.3                                       | 113%     | 16.7  |
| 15     | Tert Butyl Alcohol          | 43.8                                       | 88%      | 2.6   | 290.4                                      | 116%     | 14.2  |
| 16     | Acrylonitrile               | 9.3  | 93%      | 2.8   | 58.9                                       | 118%     | 18.0  |
| 17     | MTBE                        | 9.8  | 98%      | 8.0   | 55.3                                       | 111%     | 15.9  |
| 18     | trans-1,2-Dichloroethene    | 10.1                                       | 101%     | 4.3   | 55.8                                       | 112%     | 19.2  |
| 19     | Vinyl Acetate               | 9.7  | 97%      | 5.1   | 52.4                                       | 105%     | 6.7   |
| 20     | Isopropylether              | 9.9  | 99%      | 3.3   | 51.6                                       | 103%     | 7.6   |
| 21     | 1,1-Dichloroethane          | 10.0                                       | 100%     | 7.7   | 50.8                                       | 102%     | 6.8   |
| 22     | Ethyl Tert Butyl Ether      | 9.6  | 96%      | 2.7   | 53.2                                       | 106%     | 7.9   |
| 23     | 2-Butanone                  | 9.7  | 97%      | 5.5   | 52.8                                       | 106%     | 7.1   |
| 24     | Ethyl Acetate               | 9.8  | 98%      | 4.1   | 52.8                                       | 106%     | 6.5   |
| 25     | cis-1,2-Dichloroethene      | 10.2                                       | 102%     | 4.5   | 51.0                                       | 102%     | 6.9   |
| 26     | Propionitrile               | 9.6  | 96%      | 3.3   | 52.2                                       | 104%     | 7.8   |
| 27     | 2,2-Dichloropropane         | 11.8                                       | 118%     | 2.6   | 48.9                                       | 98%      | 5.4   |
| 28     | Methyl Acrylate             | 9.6  | 96%      | 3.9   | 52.3                                       | 105%     | 7.3   |
| 29     | Methacrylonitrile           | 9.5  | 95%      | 4.7   | 54.3                                       | 109%     | 7.0   |
| 30     | Bromochloromethane          | 10.2                                       | 102%     | 7.0   | 54.0                                       | 108%     | 7.6   |
| 31     | THF                         | 9.4  | 94%      | 5.6   | 53.5                                       | 107%     | 8.1   |
| 32     | Chloroform                  | 9.7  | 97%      | 3.3   | 54.3                                       | 109%     | 6.5   |
| 33     | Pentafluorobenzene (IS)     | NA   | NA       | NA    | NA   | NA       | NA    |
| 34     | Dibromofluoromethane (SURR) | 44.2                                       | 88%      | 2.0   | 48.6                                       | 97%      | 3.3   |
| 35     | 1,1,1-Trichloroethane       | 9.5  | 95%      | 6.3   | 56.4                                       | 113%     | 5.6   |
| 36     | 1,1-Dichloropropene         | 10.2                                       | 102%     | 5.4   | 51.5                                       | 103%     | 7.1   |
| 37     | Carbon Tetrachloride        | 9.4  | 94%      | 3.9   | 54.3                                       | 109%     | 5.6   |
| 38     | Methyl Acetate              | 9.5  | 95%      | 1.2   | 54.3                                       | 109%     | 6.9   |
| 39     | Benzene                     | 10.3                                       | 103%     | 4.3   | 50.2                                       | 100%     | 7.2   |
| 40     | 1,2-Dichloroethane          | 10.1                                       | 101%     | 14.2  | 58.5                                       | 117%     | 5.3   |
| 41     | Isobutyl Alcohol            | 8.8  | 88%      | 21.6  | 54.3                                       | 109%     | 6.9   |
| 42     | Tert Amyl Methyl Ether      | 9.6  | 96%      | 4.9   | 51.5                                       | 103%     | 7.7   |
| 43     | 1,4-Difluorobenzene (IS)    | NA   | NA       | NA    | NA   | NA       | NA    |
| 44     | Trichloroethene             | 10.8                                       | 108%     | 5.6   | 53.5                                       | 107%     | 4.8   |
| 45     | Methyl Methacrylate         | 10.1                                       | 101%     | 1.5   | 52.4                                       | 105%     | 4.7   |
| 46     | 1,2-Dichloropropane         | 10.2                                       | 102%     | 2.9   | 52.0                                       | 104%     | 5.0   |
| 47     | Propyl Acetate              | 10.1                                       | 101%     | 3.7   | 55.6                                       | 111%     | 4.9   |

Table 5: continued

| Peak # | Compound Name               | Precision and Accuracy at 10 µg/L<br>n = 8 |          |       | Precision and Accuracy at 50 µg/L<br>n = 8 |          |       |
|--------|-----------------------------|--|----------|-------|--|----------|-------|
|        |                             | Mean Concentration (µg/L)                  | Recovery | % RSD | Mean Concentration (µg/L)                  | Recovery | % RSD |
| 48     | 1,4-Dioxane                 | 15.3                                       | 76%      | 16.8  | 112.9                                      | 113%     | 10.4  |
| 49     | Dibromomethane              | 10.3                                       | 103%     | 2.6   | 57.4                                       | 115%     | 6.0   |
| 50     | Bromodichloromethane        | 10.3                                       | 103%     | 9.5   | 57.2                                       | 114%     | 4.9   |
| 51     | 2-Nitropropane              | 8.6  | 86%      | 8.5   | 54.7                                       | 109%     | 6.5   |
| 52     | 2-Chloroethylvinylether     | 8.7  | 87%      | 16.9  | 55.8                                       | 112%     | 6.7   |
| 53     | cis-1,3-Dichloropropane     | 10.5                                       | 105%     | 2.3   | 54.5                                       | 109%     | 3.9   |
| 54     | 4-Methyl-2-pentanone        | 10.0                                       | 100%     | 4.4   | 57.4                                       | 115%     | 4.3   |
| 55     | Toluene-d8 (SURR)           | 51.0                                       | 102%     | 3.8   | 52.0                                       | 104%     | 1.8   |
| 56     | Toluene                     | 10.5                                       | 105%     | 6.8   | 54.2                                       | 108%     | 4.7   |
| 57     | trans-1,3-Dichloropropene   | 10.5                                       | 105%     | 2.0   | 53.4                                       | 107%     | 4.2   |
| 58     | Ethyl Methacrylate          | 10.0                                       | 100%     | 3.2   | 52.3                                       | 105%     | 4.2   |
| 59     | 1,1,2-Trichloroethane       | 10.2                                       | 102%     | 7.6   | 55.6                                       | 111%     | 4.4   |
| 60     | Tetrachloroethane           | 11.3                                       | 113%     | 13.9  | 57.4                                       | 115%     | 5.3   |
| 61     | 1,3-Dichloropropane         | 10.2                                       | 102%     | 2.3   | 53.2                                       | 106%     | 4.1   |
| 62     | 2-Hexanone                  | 9.9  | 99%      | 4.2   | 56.1                                       | 112%     | 4.9   |
| 63     | Isopropyl Acetate           | 9.8  | 98%      | 5.1   | 55.1                                       | 110%     | 4.1   |
| 64     | Butyl Acetate               | 9.8  | 98%      | 3.7   | 55.7                                       | 111%     | 4.5   |
| 65     | Dibromochloromethane        | 10.2                                       | 102%     | 6.1   | 56.0                                       | 112%     | 4.6   |
| 66     | 1,2-Dibromoethane           | 10.0                                       | 100%     | 3.0   | 55.5                                       | 111%     | 4.6   |
| 67     | Chlorobenzene-d5 (IS)       | NA   | NA       | NA    | NA   | NA       | NA    |
| 68     | Chlorobenzene               | 10.4                                       | 104%     | 4.1   | 53.7                                       | 107%     | 4.6   |
| 69     | 1,1,1,2-Tetrachloroethane   | 10.5                                       | 105%     | 9.3   | 51.3                                       | 103%     | 4.4   |
| 70     | Ethylbenzene                | 10.7                                       | 107%     | 10.6  | 54.0                                       | 108%     | 4.5   |
| 71     | Xylene (m&p)                | 21.5                                       | 107%     | 10.6  | 111.5                                      | 111%     | 4.8   |
| 72     | Xylene (o)                  | 10.5                                       | 105%     | 10.4  | 54.1                                       | 108%     | 4.5   |
| 73     | Styrene                     | 9.9  | 99%      | 5.2   | 53.3                                       | 107%     | 4.6   |
| 74     | n-Amyl Acetate              | 9.9  | 99%      | 6.6   | 55.9                                       | 112%     | 4.7   |
| 75     | Bromoform                   | 9.9  | 99%      | 5.2   | 57.6                                       | 115%     | 5.2   |
| 76     | Isopropylbenzene            | 9.7  | 97%      | 6.8   | 55.8                                       | 112%     | 5.0   |
| 77     | BFB(SURR)                   | 49.2                                       | 98%      | 2.0   | 49.2                                       | 98%      | 1.3   |
| 78     | 1,1,2,2-Tetrachloroethane   | 9.5  | 95%      | 5.0   | 54.4                                       | 109%     | 4.2   |
| 79     | Bromobenzene                | 10.2                                       | 102%     | 3.1   | 54.0                                       | 108%     | 4.6   |
| 80     | 1,2,3-Trichloropropane      | 9.6  | 96%      | 6.3   | 52.2                                       | 104%     | 4.1   |
| 81     | n-Propylbenzene             | 10.0                                       | 100%     | 5.9   | 55.8                                       | 112%     | 5.3   |
| 82     | 2-Chlorotoluene             | 10.3                                       | 103%     | 4.2   | 52.9                                       | 106%     | 4.4   |
| 83     | 1,3,5-Trimethylbenzene      | 9.7  | 97%      | 6.2   | 54.8                                       | 110%     | 4.8   |
| 84     | 4-Chlorotoluene             | 10.2                                       | 102%     | 3.6   | 52.1                                       | 104%     | 5.1   |
| 85     | tert-Butylbenzene           | 10.0                                       | 100%     | 5.1   | 53.2                                       | 106%     | 4.4   |
| 86     | 1,2,4-Trimethylbenzene      | 9.6  | 96%      | 6.3   | 53.4                                       | 107%     | 4.9   |
| 87     | sec-Butylbenzene            | 10.7                                       | 107%     | 4.4   | 52.9                                       | 106%     | 5.3   |
| 88     | 1,3-Dichlorobenzene         | 10.2                                       | 102%     | 4.7   | 50.9                                       | 102%     | 4.3   |
| 89     | Isopropyltoluene            | 10.0                                       | 100%     | 5.1   | 51.5                                       | 103%     | 5.5   |
| 90     | 1,4-Dichlorobenzene-d4 (IS) | NA   | NA       | NA    | NA   | NA       | NA    |
| 91     | 1,4-Dichlorobenzene         | 10.2                                       | 102%     | 4.2   | 54.0                                       | 108%     | 4.4   |
| 92     | n-Butylbenzene              | 10.2                                       | 102%     | 5.5   | 55.8                                       | 112%     | 5.7   |
| 93     | 1,2-Dichlorobenzene         | 10.4                                       | 104%     | 2.9   | 53.9                                       | 108%     | 4.0   |
| 94     | 1,2-Dibromo-3-chloropropane | 9.7  | 97%      | 3.2   | 56.5                                       | 113%     | 5.8   |
| 95     | Nitrobenzene                | 10.0                                       | 100%     | 7.2   | 48.0                                       | 96%      | 7.2   |
| 96     | 1,2,4-Trichlorobenzene      | 10.3                                       | 103%     | 4.6   | 55.5                                       | 111%     | 4.4   |
| 97     | Hexachlorobutadiene         | 11.0                                       | 110%     | 5.7   | 60.4                                       | 121%     | 6.0   |
| 98     | Naphthalene                 | 10.4                                       | 104%     | 3.2   | 51.0                                       | 102%     | 3.3   |
| 99     | 1,2,3-Trichlorobenzene      | 10.3                                       | 103%     | 4.7   | 54.3                                       | 109%     | 3.9   |

Internal standard response remained stable during the entire study at  $\leq 8\%$ , and Surrogate recoveries fell within the 80 to 120 % method criteria for all

analyses. IS and SURR results from a representative 12-hour sequence are shown in Figures 4 and 5, respectively.

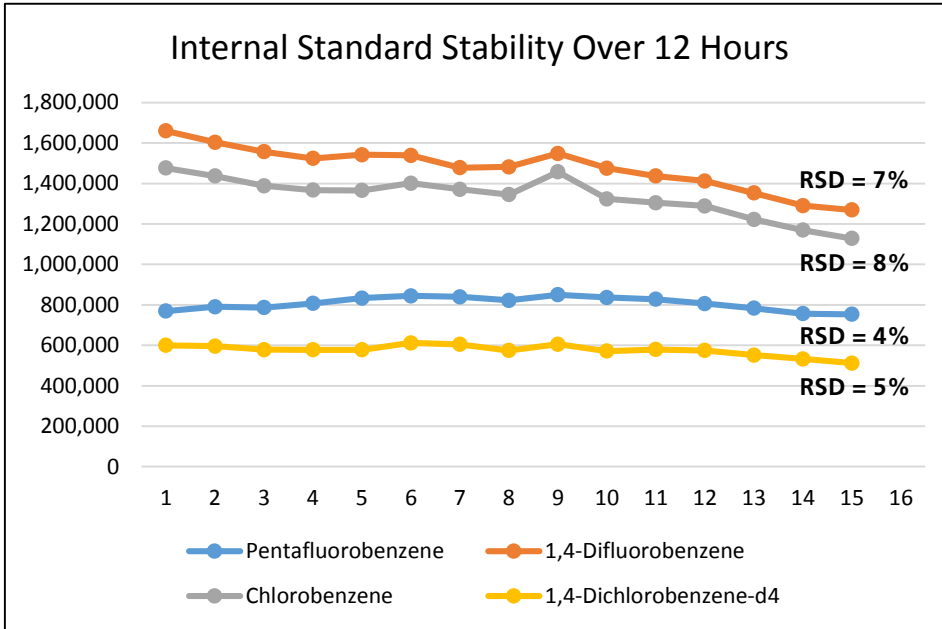


Figure 4: Internal Standard Response over a Representative 12-Hour Tune Period during This Study

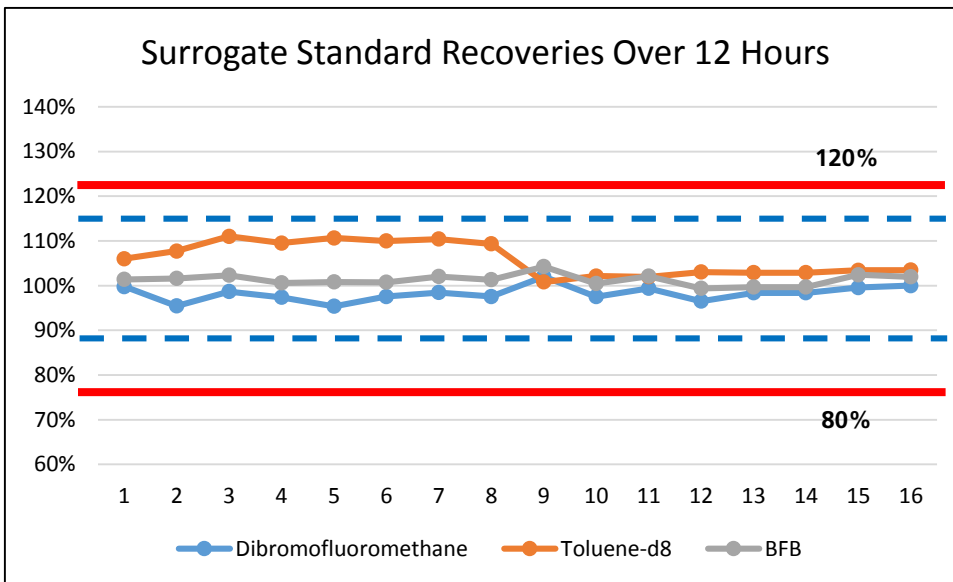


Figure 5: Surrogate Standard Recoveries over a Representative 12-hour Tune Period during This Study



### ■ Summary and Conclusion

The instrumentation and analytical conditions shown here have been demonstrated to provide outstanding results for US EPA Method 8260C, far exceeding all existing method criteria. The narrow-bore capillary column and Constant Linear Velocity mode provided outstanding chromatography for all compounds, including the early-eluting light gases, in less than 13 minutes. Calibration curves over

narrow or wide ranges can be used to meet the project or contract needs. MDLs are easily well below 0.5 µg/L for all compounds when measured at either 0.5 or 1.0 µg/L, and a high level of precision and accuracy can be expected across any calibration range, particularly at the lower concentrations.



### ■ References

1. US EPA Method 8260C, VOLATILE ORGANIC COMPOUNDS BY GAS CHROMATOGRAPHY/MASS SPECTROMETRY (GC/MS), Revision 3, August 2006.
2. Shimadzu Guide to BFB Tuning for Analysis of Volatile Organic Compounds, GCMS Application News No. GCMS-1405.
3. Definition and Procedure for the Determination of the Method Detection Limit. *Fed. Regist.* **1984**. 49 (209), Appendix B to Part 136.
4. Shimadzu Guide to US EPA Method 624 for Analysis of Volatile Organic Compounds in Wastewater, GCMS Application News No. GCMS-1406.

### ■ Ordering Information for Replacement Consumables

The consumables used in this application note are shown in the table below. To order any of these items please contact Customer Service at Shimadzu Scientific Instruments at 1-800-477-1227, or visit our web store at <http://store.shimadzu.com>.

| Part Number     | Item Name                                      | Photo   | Item Description  |
|-----------------|--|---|---|
| 221-75962-30    | Capillary Column                               |  | SH-RXI-624 SIL MS, 30 m x 0.25 mm x 1.40 µm   |
| 220-90784-10    | Inlet Liner                                    |  | Low-volume Liner, 1.0 mm ID, Straight, 5/Pkg (Restek)   |
| 220-94775-10    | VOA Tuning Compound                            |  | 1-Bromo-4-fluorobenzene (BFB), 5,000 µg/mL in P&T MeOH, 1 mL/ampule, CAS #: 460-00-4 (Restek) |
| 220-94775-14    | 502.2 Calibration Mix #1, Gases (6 Components) |  | 2,000 µg/mL each in P&T MeOH, 1 mL/ampule (Restek)  |
| Restek PN 30633 | 8260 MegaMix Calibration Mix (76 components)   |  | 2,000 µg/mL each in P&T MeOH, 1 mL/ampule (Restek)  |
| Restek PN 30465 | California Oxygenates Mix (5 components)       |  | 2,000 µg/mL each in P&T MeOH, 1 mL/ampule (Restek) (TBA at 10,000 µg/mL)                      |

|                 |   |   |   |
|-----------------|---|---|---|
| Restek PN 32087 | 1,4-Dioxane                                     |    | 2,000 µg/mL each in P&T MeOH, 1 mL/ampule (Restek)  |
| Restek PN 30006 | VOA Calibration Mix #1 (ketones) (4 components) |    | 5,000 µg/mL each in P&T MeOH, 1 mL/ampule (Restek)  |
| Restek PN 30489 | 8260 Acetate Mix                                |    | 2,000 µg/mL each in P&T MeOH, 1 mL/ampule (Restek)  |
| Restek PN 30265 | 2-CLEVE   |    | 2,000 µg/mL each in P&T MeOH, 1 mL/ampule (Restek)  |
| Restek PN 30073 | 8260 Surrogate Mix (3 components)               |    | 2,500 µg/mL each in P&T MeOH, 1 mL/ampule (Restek)  |
| Restek PN 30074 | 8260 Internal Standard Mix (4 components)       |    | 2,500 µg/mL each in P&T MeOH, 1 mL/ampule (Restek)  |
| 220-94775-00    | n-Alkane Mix                                    |   | AART Standard for determination of Retention Index (RI) and Retention Times (RT)          |
| 220-94594-00    | Electronic Flow Meter                           |  | ProFLOW 6000 Electronic Flow Meter (Restek)   |
| 220-94594-01    | Electronic Leak Detector                        |  | Electronic Leak Detector With Hard-Sided Carrying Case and Universal Charger Set (Restek) |

First Edition: June 2015



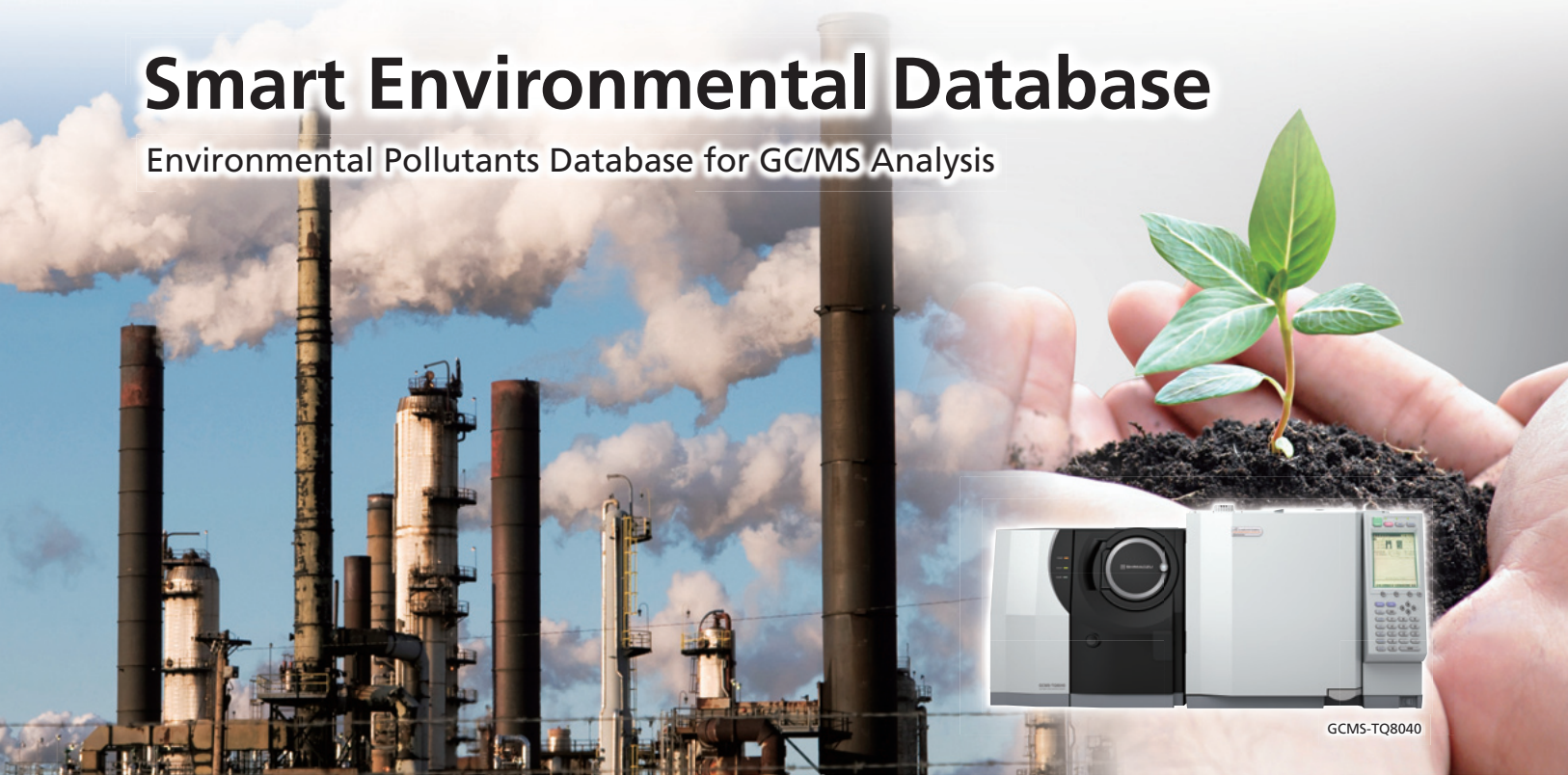
**SHIMADZU Corporation**  
[www.shimadzu.com/an/](http://www.shimadzu.com/an/)

**SHIMADZU SCIENTIFIC INSTRUMENTS**  
7102 Riverwood Drive, Columbia, MD 21046, USA  
Phone: 800-477-1227/410-381-1227, Fax: 410-381-1222  
URL: [www.ssi.shimadzu.com](http://www.ssi.shimadzu.com)

For Research Use Only. Not for use in diagnostic procedures.  
The contents of this publication are provided to you "as is" without warranty of any kind, and are subject to change without notice. Shimadzu does not assume any responsibility or liability for any damage, whether direct or indirect, relating to the use of this publication.

# Smart Environmental Database

## Environmental Pollutants Database for GC/MS Analysis



GCMS-TQ8040

### Create MRM Methods for GC-MS/MS

The Shimadzu Smart Environmental Database contains all the information necessary to create MRM methods for over 500 environmental pollutants, including polychlorinated biphenyls (PCBs), brominated flame retardants (BFRs), dioxins, polycyclic aromatic hydrocarbons (PAHs), organochlorine pesticides (OCPs), and stable isotopically labeled compounds that are commonly used as Internal and Surrogate Standards. The database includes up to six fully optimized MRM transitions for all compounds, plus retention indices (RI) for setting correct retention times, CAS numbers, and other compound-specific information.

Optimized analytical methods for each compound class, including the recommended capillary column and GC oven program, are part of the database package to minimize start-up time.

| Serial | Type   | Reg. Name | GC/MS | Retention | Compound Name (J)            | Type | RI            | CR | SRM      | Type  | RI            | CR | SRM      |
|--------|--------|-----------|-------|-----------|------------------------------|------|---------------|----|----------|-------|---------------|----|----------|
| 1      | Target | MRI       | 1     | 5         | 2-Chlorobiphenyl (2Cl)       | F    | 188 (2-182.0) | 24 | 100 (20) | Ref 1 | 188 (2-182.0) | 24 | 100 (20) |
| 2      | Target | MRI       | 2     | 1         | 2-Chlorobiphenyl (2Cl)       | F    | 188 (2-182.0) | 24 | 100 (20) | Ref 1 | 188 (2-182.0) | 24 | 100 (20) |
| 3      | Target | MRI       | 3     | 1         | 2-Chlorobiphenyl (2Cl)       | F    | 188 (2-182.0) | 24 | 100 (20) | Ref 1 | 188 (2-182.0) | 24 | 100 (20) |
| 4      | Target | MRI       | 4     | 1         | 2,2-Dichlorobiphenyl (2,2Cl) | F    | 222 (2-182.0) | 24 | 100 (20) | Ref 1 | 222 (2-182.0) | 24 | 100 (20) |
| 5      | Target | MRI       | 5     | 1         | 2,2-Dichlorobiphenyl (2,2Cl) | F    | 222 (2-182.0) | 24 | 100 (20) | Ref 1 | 222 (2-182.0) | 24 | 100 (20) |
| 6      | Target | MRI       | 6     | 1         | 2,4-Dichlorobiphenyl (2,4Cl) | F    | 222 (2-182.0) | 24 | 100 (20) | Ref 1 | 222 (2-182.0) | 24 | 100 (20) |
| 7      | Target | MRI       | 7     | 1         | 2,4-Dichlorobiphenyl (2,4Cl) | F    | 222 (2-182.0) | 24 | 100 (20) | Ref 1 | 222 (2-182.0) | 24 | 100 (20) |
| 8      | Target | MRI       | 8     | 1         | 2,4-Dichlorobiphenyl (2,4Cl) | F    | 222 (2-182.0) | 24 | 100 (20) | Ref 1 | 222 (2-182.0) | 24 | 100 (20) |
| 9      | Target | MRI       | 9     | 1         | 2,4-Dichlorobiphenyl (2,4Cl) | F    | 222 (2-182.0) | 24 | 100 (20) | Ref 1 | 222 (2-182.0) | 24 | 100 (20) |
| 10     | Target | MRI       | 10    | 1         | 2,4-Dichlorobiphenyl (2,4Cl) | F    | 222 (2-182.0) | 24 | 100 (20) | Ref 1 | 222 (2-182.0) | 24 | 100 (20) |
| 11     | Target | MRI       | 11    | 1         | 2,4-Dichlorobiphenyl (2,4Cl) | F    | 222 (2-182.0) | 24 | 100 (20) | Ref 1 | 222 (2-182.0) | 24 | 100 (20) |

### Accurate Retention Time Update via AART

The Automatic Adjustment of Retention Time (AART) function is a standard feature of all Shimadzu GCMS packages, and allows the user to quickly and easily perform multipoint retention time updates using the fundamental principle of Retention Indices. The Smart Database Series includes RIs for all registered compounds for easy implementation of the AART function.

### Smart MRM Optimizes Methods Automatically

The Shimadzu Smart MRM feature allows the user to create fully optimized MRM and Scan/MRM methods automatically. GC-MS/MS Dwell, Event, and Loop times can be difficult to optimize when dozens, or even hundreds of compounds are to be analyzed simultaneously. The Smart MRM feature automatically determines the optimum Dwell, Event, and Loop settings using flexible MRM events, and creates MRM and Scan/MRM methods that provide the best sensitivity for all compounds in a single method.

### Smart MRM



Applicable Models: GCMS-TQ8040 and GCMS-TQ8030

Operating Environment

OS: Microsoft® Windows® 7 Professional

Excel: Microsoft® Excel® 2010 (32-bit version), Excel® 2013 (32-bit version)

Workstation Software: GCMSsolution ver. 4.30 or later

# Smart Environmental Database

Environmental Pollutants Database for GC/MS Analysis

## Database Configuration

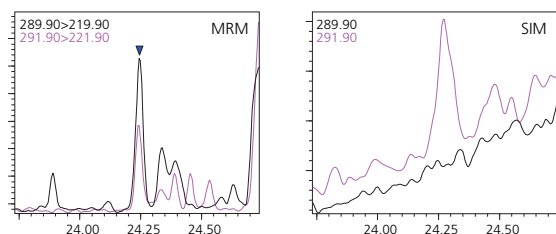
| Registered Compounds             | Number of Registered Compounds | Number of Registered Compounds Labeled with Stable Isotopes |
|----------------------------------|--------------------------------|---|
| Polychlorinated biphenyls        | 209                            | 45  |
| Brominated flame retardants      | 55                             | 28  |
| Dioxins                          | 32                             | 26  |
| Polycyclic aromatic hydrocarbons | 38                             | 37  |
| Organochlorine pesticides        | 32                             | 25  |

The Smart Environmental Database consists of an Excel spreadsheet containing RIs, CAS numbers, and optimized MRM transitions for the compounds shown in the table above. It also includes method files for data acquisition and analysis, so analysis can begin with minimal start-up time.

Note: The retention indices registered in the database are calculated using the analysis conditions registered in the AART method file. If you are using the registered retention indices, use the identical conditions.

## Sensitive Analysis via MRM

Analysis of PCB in River Water  
(2,2',5,5'-Tetrachlorobiphenyl (#52) concentration in water of 0.080 ng/L)



Analysis of environmental pollutants using the triple quadrupole MRM mode improves both sensitivity and selectivity, compared to the single quadrupole SIM mode, especially in cases where co-extracted contaminants might interfere with the analysis.

### Remarks and Precautions

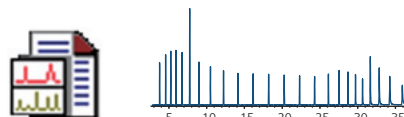
1. The accuracy of the information contained in the database and the usefulness of information obtained as a result of the use of this information is not guaranteed.
2. Be sure to test the qualitative and quantitative information obtained with this system using a standard sample for confirmation.
3. To reliably identify substances registered with this database, perform measurement using the system requirements of the method template file included with the product.

## Procedure for Creating MRM Methods Using Shimadzu Smart Environmental Database

1. Analyze an aliquot of the *n*-alkane mixture.



2. Update retention times using the AART function.



| Sample | Type   | File Name | GC | MS | Method | Temp | Temp | Temp | Temp | Temp | Temp | Temp | Temp |
|--------|--------|-----------|----|----|--------|------|------|------|------|------|------|------|------|
| 1      | Target | alkane    | 1  | 1  | 1      | 200  | 200  | 200  | 200  | 200  | 200  | 200  | 200  |
| 2      | Target | alkane    | 1  | 1  | 1      | 200  | 200  | 200  | 200  | 200  | 200  | 200  | 200  |
| 3      | Target | alkane    | 2  | 1  | 1      | 200  | 200  | 200  | 200  | 200  | 200  | 200  | 200  |
| 4      | Target | alkane    | 3  | 1  | 1      | 200  | 200  | 200  | 200  | 200  | 200  | 200  | 200  |
| 5      | Target | alkane    | 3  | 1  | 1      | 200  | 200  | 200  | 200  | 200  | 200  | 200  | 200  |
| 6      | Target | alkane    | 3  | 1  | 1      | 200  | 200  | 200  | 200  | 200  | 200  | 200  | 200  |
| 7      | Target | alkane    | 3  | 1  | 1      | 200  | 200  | 200  | 200  | 200  | 200  | 200  | 200  |
| 8      | Target | alkane    | 3  | 1  | 1      | 200  | 200  | 200  | 200  | 200  | 200  | 200  | 200  |
| 9      | Target | alkane    | 3  | 1  | 1      | 200  | 200  | 200  | 200  | 200  | 200  | 200  | 200  |
| 10     | Target | alkane    | 3  | 1  | 1      | 200  | 200  | 200  | 200  | 200  | 200  | 200  | 200  |
| 11     | Target | alkane    | 3  | 1  | 1      | 200  | 200  | 200  | 200  | 200  | 200  | 200  | 200  |



3. Use Smart MRM to create the MRM or Scan/MRM method automatically from the Smart Environmental Database.



| Sample | Type   | File Name | GC | MS | Method | Temp | Temp | Temp | Temp | Temp | Temp | Temp | Temp |
|--------|--------|-----------|----|----|--------|------|------|------|------|------|------|------|------|
| 1      | Target | alkane    | 1  | 1  | 1      | 200  | 200  | 200  | 200  | 200  | 200  | 200  | 200  |
| 2      | Target | alkane    | 1  | 1  | 1      | 200  | 200  | 200  | 200  | 200  | 200  | 200  | 200  |
| 3      | Target | alkane    | 2  | 1  | 1      | 200  | 200  | 200  | 200  | 200  | 200  | 200  | 200  |
| 4      | Target | alkane    | 3  | 1  | 1      | 200  | 200  | 200  | 200  | 200  | 200  | 200  | 200  |
| 5      | Target | alkane    | 3  | 1  | 1      | 200  | 200  | 200  | 200  | 200  | 200  | 200  | 200  |
| 6      | Target | alkane    | 3  | 1  | 1      | 200  | 200  | 200  | 200  | 200  | 200  | 200  | 200  |
| 7      | Target | alkane    | 3  | 1  | 1      | 200  | 200  | 200  | 200  | 200  | 200  | 200  | 200  |
| 8      | Target | alkane    | 3  | 1  | 1      | 200  | 200  | 200  | 200  | 200  | 200  | 200  | 200  |
| 9      | Target | alkane    | 3  | 1  | 1      | 200  | 200  | 200  | 200  | 200  | 200  | 200  | 200  |
| 10     | Target | alkane    | 3  | 1  | 1      | 200  | 200  | 200  | 200  | 200  | 200  | 200  | 200  |
| 11     | Target | alkane    | 3  | 1  | 1      | 200  | 200  | 200  | 200  | 200  | 200  | 200  | 200  |



Shimadzu Corporation  
www.shimadzu.com/an/

Company names, product/service names and logos used in this publication are trademarks and trade names of Shimadzu Corporation or its affiliates, whether or not they are used with trademark symbol "TM" or "®". Third-party trademarks and trade names may be used in this publication to refer to either the entities or their products/services. Shimadzu disclaims any proprietary interest in trademarks and trade names other than its own.

For Research Use Only. Not for use in diagnostic procedures. The contents of this publication are provided to you "as is" without warranty of any kind, and are subject to change without notice. Shimadzu does not assume any responsibility or liability for any damage, whether direct or indirect, relating to the use of this publication.

# Application News

## No. AD-0125

Water Analysis / LCMS-8050

### A High Sensitivity Method for Quantitative Determination of Ten Phenols in Surface Water on LC/MS/MS with APCI Interface

#### Introduction

There are a variety of phenolic compounds such as alkylphenols (AP), chlorophenols (CP), nitrophenols (NP), bisphenol A (BPA) and triclosan, etc. Phenols are widely used as chemical precursors in industries and for other purposes in agriculture, medical and domestic processes. Many phenolic compounds are toxic and carcinogenic to human and they are classified as the priority pollutants in surface and drinking waters [1, 2]. The US Environmental Protection Agency (EPA) and the European Community (EC) have set a legal tolerance level of 0.5 µg/L for total phenols and 0.1 µg/L for individual phenolic compound in drinking water [3,4]. Japan's MHLW (Ministry of Health, Labor and Welfare) has designated six phenols as the index of water quality standard requirements. Various analytical methods such as GC, GCMS, HPLC and LC/MS/MS have been used for detection and quantitation of phenols in drinking waters [5, 6]. These methods require sample pre-treatments including derivatization and/or pre-concentration by SPE, etc. In this Application News, a MRM based method is described, which was developed for detection and quantitation of phenol and nine substituted phenols (see Table 2) in treated water and reservoir water on triple quadrupole LC/MS/MS with an APCI interface.

#### Experimental

##### Analytical conditions

A LCMS-8050 triple quadrupole system coupled with Nexera UHPLC system was employed in this work. A pentafluorophenyl (PFP) column from Phenomenex was used with an optimized gradient elution program for ten phenols. Details of the HPLC conditions and MS/MS conditions are shown in Table 1.

##### Preparation of standards and water samples

Phenol and nine substituted phenols including three chlorophenols (CP), four nitrophenols (NP) and two alkylphenols (AP) are listed in Table 2. Standard stock solutions were prepared in MeOH, which were diluted in series with MilliQ water to obtain calibrants of 50, 100, 250, 500, 1000, 2500, 5000 and 10,000 ng/L. The testing samples were obtained from a third party laboratory, including treated water, local reservoir water and a few spiked samples as controls. All the water samples were injected to LC/MS/MS without any pre-treatment or enrichment.

Table 1: Analytical conditions of phenols on LCMS-8050

|                        |  |
|------------------------|--|
| <b>Column</b>          | Kinetex 2.6u PFP 100A (100 mm L. x 2.10mm I.D.)                                  |
| <b>Mobile Phase</b>    | A: Water<br>B: Methanol  |
| <b>Elution Program</b> | Gradient elution, 5%B (0.00-0.01 min), 95%B (5.00-6.40 min), 5%B (6.41-8.00 min) |
| <b>Flow Rate</b>       | 0.5 mL/min   |
| <b>Oven Temp.</b>      | 40 °C  |
| <b>Injection</b>       | 10 µL  |
| <b>Interface</b>       | APCI   |
| <b>MS Mode</b>         | MRM, Negative mode   |
| <b>Block Temp.</b>     | 200 °C   |
| <b>DL Temp.</b>        | 200 °C   |
| <b>Interface Temp.</b> | 500 °C   |
| <b>Nebulizing gas</b>  | N <sub>2</sub> , 4.0 L/min   |
| <b>Drying gas</b>      | N <sub>2</sub> , 5.0 L/min   |

#### Results and Discussion

##### A. Establishment of MRM method for ten phenols

The MRM optimization was carried out with 1ppm mixed standards by direct injection or on-column method. Two MRM transitions were selected for each compound, with one as quantifying ion and the other for confirmation. Details of

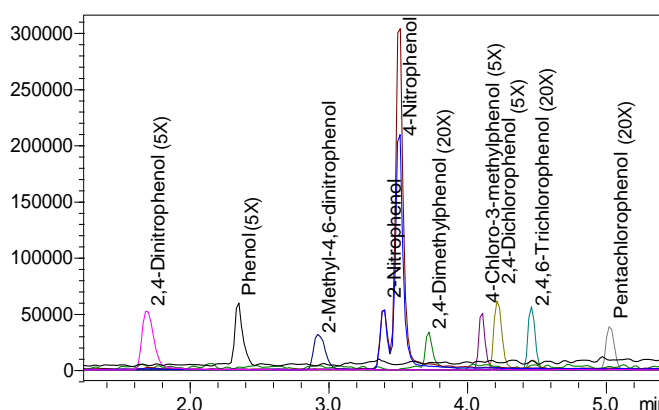
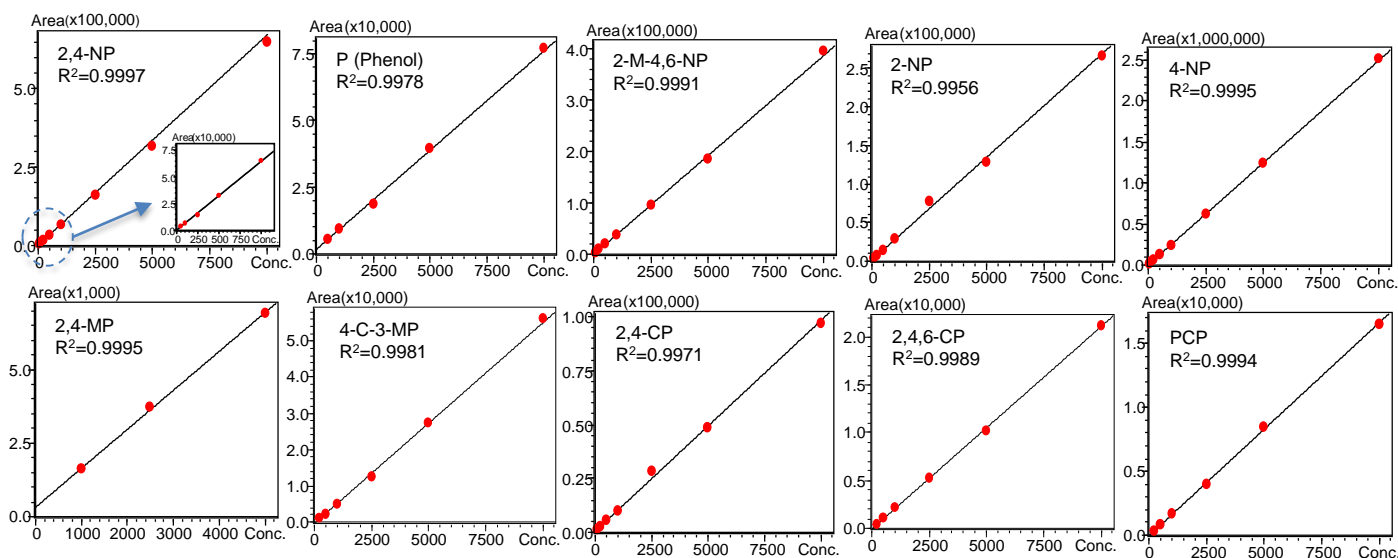


Figure 1: MRM chromatogram of ten substituted phenols in a mixed standard solution with each 5 µg/L.

**Table 2:** Summary of calibration range, linearity and detection sensitivity of MRM for substituted phenols on LCMS-8050

| Compound                   | Abbr.      | MRM Parameter |         |        |               | RT and Calibration Curve |              |                |            |            |             |
|----------------------------|------------|---------------|---------|--------|---------------|--------------------------|--------------|----------------|------------|------------|-------------|
|                            |            | Precursor     | Product | CE (V) | Relative Int. | RT (min)                 | Range (µg/L) | R <sup>2</sup> | LOD (µg/L) | LOQ (µg/L) | %RSD (n=3)* |
| 2,4-dinitrophenol          | 2,4-NP     | 183.0         | 109.1   | 26     | 100           | 1.70                     | 0.05 – 10    | 0.9997         | 0.05       | 0.15       | 5.4%        |
|                            |            |               | 123.0   | 21     | 33            |                          |              |                |            |            |             |
| Phenol                     | P          | 93.1          | 65.0    | 24     | 100           | 2.36                     | 0.5 – 10     | 0.9978         | 1.0        | 3.0        | 3.2%        |
| 2-methyl-4,6-dinitrophenol | 2-M-4,6-NP | 197.0         | 180.1   | 20     | 100           | 2.94                     | 0.1 – 10     | 0.9991         | 0.05       | 0.15       | 12.1%       |
|                            |            |               | 137.1   | 20     | 74            |                          |              |                |            |            |             |
| 2-nitrophenol              | 2-NP       | 138.0         | 108.0   | 18     | 100           | 3.40                     | 0.1 – 10     | 0.9956         | 0.1        | 0.3        | 8.9%        |
|                            |            |               | 46.1    | 28     | 55            |                          |              |                |            |            |             |
| 4-nitrophenol              | 4-NP       | 138.1         | 108.1   | 22     | 100           | 3.51                     | 0.05 – 10    | 0.9995         | 0.02       | 0.06       | 5.4%        |
|                            |            |               | 92.1    | 24     | 17            |                          |              |                |            |            |             |
| 2,4-dimethylphenol         | 2,4-MP     | 121.1         | 91.1    | 21     | 100           | 3.73                     | 1.0 – 5      | 0.9995         | 1.0        | 3.0        | 8.8%        |
|                            |            |               | 106.1   | 23     | 65            |                          |              |                |            |            |             |
| 4-chloro-3-methylphenol    | 4-C-3-MP   | 141.0         | 35.0    | 21     | 100           | 4.11                     | 0.1 – 10     | 0.9981         | 0.1        | 0.3        | 12.4%       |
|                            |            |               | 105.0   | 18     | 30            |                          |              |                |            |            |             |
| 2,4-dichlorophenol         | 2,4-CP     | 160.9         | 125.0   | 20     | 100           | 4.23                     | 0.1 – 10     | 0.9971         | 0.05       | 0.015      | 8.1%        |
|                            |            |               | 35.1    | 25     | 43            |                          |              |                |            |            |             |
| 2,4,6-trichlorophenol      | 2,4,6-CP   | 194.9         | 35.0    | 29     | 100           | 4.47                     | 0.1 – 10     | 0.9989         | 0.1        | 0.3        | 8.0%        |
|                            |            |               | 196.8   | 35.1   | 27            |                          |              |                |            |            |             |
| Pentachlorophenol          | PCP        | 262.9         | 35.0    | 25     | 100           | 5.03                     | 0.1 – 10     | 0.9994         | 0.1        | 0.3        | 1.4%        |
|                            |            |               | 264.9   | 35.0   | 29            |                          |              |                |            |            |             |

\* Data obtained with the concentration levels closest to LOQ of the compound



**Figure 2:** Calibration curves of ten phenol standards in MRM mode with an injection volume of 10 µL. Constructed with weighing method 1/C.

the MRM parameters are compiled into Table 2. The current method has adopted an APCI interface due to the relatively low polarity of some phenolic compounds including phenol and 2,4-MP. Figure 1 shows the MRM chromatograms of the ten phenols in a mixed standard solution. It is worth to note that the isomer pair of 2-NP and 4-NP can be separated and detected under the conditions at retentions of 3.40 minutes and 3.51 minutes, respectively. The MRM transitions of 2-NP and 4-NP are similar including 138>108, 138>46 and 138>92, but the intensity ratios of quantifying ion (138>108) to reference ions are different (see Table 2).

The calibration curves for quantitation of the compounds are shown in Figure 2. Good linearity of R<sup>2</sup> > 0.995 was obtained for the calibration range from 0.05 µg/L to 10 µg/L (except for 2,4-MP). The LODs of the method estimated from the lowest calibration points are at 0.02 ~ 0.25 µg/L except for Phenol and 2,4-MP (LOD = 1.0 µg/L).

## B. Analysis of Treated Water and Reservoir Water

The MRM quantitation method established was applied to actual samples, a treated water S1 and a reservoir water S2, for detection of the targeted ten phenols. The water samples and two control samples (C/H and C/L) were obtained from a third party laboratory. These samples were injected into the LC/MS/MS without further pre-treatment or pre-concentration. The analysis results are summarized in Table 3. All the ten phenols were detected and quantified in the control sample C/H and in C/L (L=low) except 2,4-MP. However, the levels of phenol and 2,4-MP are below the LODs as remarked in the table. In the actual surface water samples S1 and S2, only 2-NP and 4-NP were detected and quantified. A suspected peak of 2,4-P was observed in S2, but its level (0.03 µg/L) is below the LOD of the method (0.05 µg/L). The individual MRM peaks of 2-NP, 4-NP and 2,4-NP of samples S1 and S2 are shown in Figure 3.

**Table 3:** Quantitation results of ten phenols in water samples

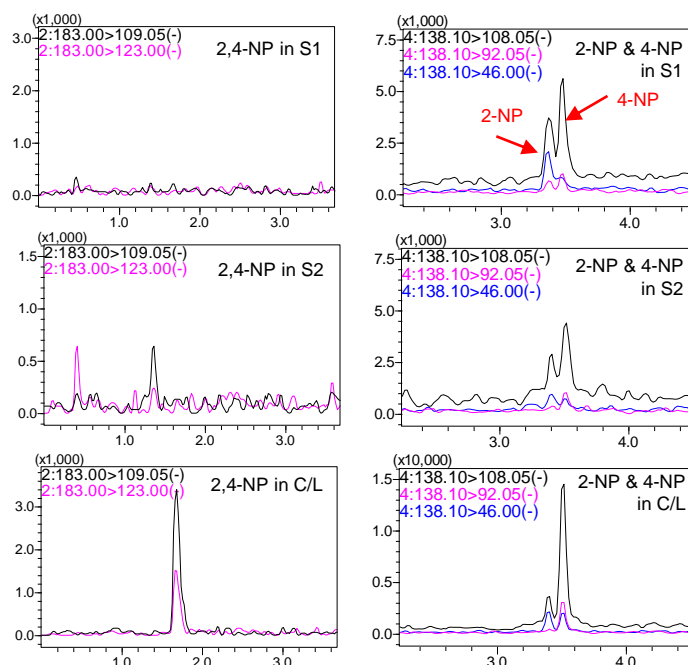
| Compd.     | RT (min) | Phenols in Water Samples (µg/L) |        |      |        |
|------------|----------|---------------------------------|--------|------|--------|
|            |          | C/L                             | C/H    | S1   | S2     |
| 2,4-NP     | 1.70     | 0.30                            | 0.79   | N.D. | ~0.03* |
| P          | 2.36     | ~0.32*                          | ~0.66* | N.D. | N.D.   |
| 2-M-4,6-NP | 2.94     | 0.17                            | 0.75   | N.D. | N.D.   |
| 2-NP       | 3.40     | 0.23                            | 0.67   | 0.28 | 0.17   |
| 4-NP       | 3.51     | 0.22                            | 0.45   | 0.08 | 0.08   |
| 2,4-MP     | 3.73     | N.D.                            | ~0.62* | N.D. | N.D.   |
| 4-C-3-MP   | 4.1      | 0.18                            | 0.63   | N.D. | N.D.   |
| 2,4-CP     | 4.2      | 0.14                            | 0.64   | N.D. | N.D.   |
| 2,4,6-CP   | 4.5      | 0.15                            | 0.71   | N.D. | N.D.   |
| PCP        | 5.0      | 0.29                            | 0.74   | N.D. | N.D.   |

\* Lower than LODs of the method; N.D. = Not Detected

In summary, this study focuses on evaluation of a MRM based method and its applicability in detection and quantitation of trace levels of phenol and substituted phenols in surface water samples. The results indicate the high sensitivity of the method, which offers a possibility to determine these substituted phenols directly to achieve the required LOD of 0.1 µg/L [3,4] without the need of pre-concentration. However, the sensitivity for phenol and 2,4-MP are not sufficient, which is likely related to their poorer ionization due to low polarity of the molecules. Sample concentration of ten times or more before analysis is needed.

## Conclusions

A MRM-based LC-APCI-MS/MS method with fast gradient elution of 8 minutes was established and evaluated for detection and quantitation of ten phenols in surface waters. The limits of detection (LOD) of the method achieved are better than 0.1 µg/L for each individual compound except phenol and 2,4-MP, which LODs are at 1.0 µg/L. The high sensitivity of the method for the eight substituted phenols offers the possibility to determine them quantitatively and directly without the need of pre-concentration. For phenol and 2,4-MP, it requires at least ten times of pre-concentration before analysis.



**Figure 3:** MRM peaks of 2,4-NP (left) and 2-NP & 4-NP (right) in samples S1, S2 and C/L with injection volume of 10 µL on LCMS-8050 with APCI interface.

## References

1. Michałowicz J, Bukowska B, Duda W, Chemosphere 71 (2008): 735-741.
2. Mnif A, Tabassi D, Sik Ali M, Hamrouni B, Environmental Progress & Sustainable Energy 34 (2015): 982-989.
3. Drinking Water Directive 80/778/EEC, Commission of the European Communities (1980).
4. U.S. EPA Title 40, Chapter 1, Part 141, National Primary Drinking Water Regulation.
5. Zhong C, He M, Liao H, Chen B, Wang C, Hu B, J. Chromatogr. A 1441 (2016): 8-15.
6. Application News No. C96, Shimadzu <http://www.shimadzu.com/an/lc-datasheet.html>

**Disclaimer:** The data and instruments presented in this Application News are intended for Research Use Only (RUO). Not for use in diagnostic procedures.

# Application News

No. AD-0126

## Water Analysis / LCMS-8060

### Quantitative Analysis of Residual Artificial Sweeteners in Surface Water by Highly Sensitive LC/MS/MS Method

#### □ Introduction

Artificial sweeteners, being low caloric sugar substitutes, are widely used in food and beverages for decades. Researches on environmental occurrence and ecotoxicological effects of artificial sweeteners have increased in recent years [1]. Artificial sweeteners are found in surface waters and wastewaters at levels from ng/L to µg/L [1-3], which are classified as new emerging environmental contaminants. The artificial sweeteners which have been studied most in this field are acesulfame (ACE), cyclamate (CYC), saccharin (SAC) and sucralose (SUC) [1-4]. LC/MS/MS techniques have been used in these studies. However, pre-concentration of water sample is often required because of the needs for detection of trace levels of the compounds. A LC/MS/MS method was developed previously on LCMS-8040 for identification and quantification of ten artificial sweeteners in beverages [5]. In this Application News, a new LC/MS/MS method on LCMS-8060 is described, aiming at achieving ultra high sensitivity for direct quantitation of above-mentioned five artificial sweeteners in surface waters and drinking waters.

#### □ Experimental

##### Analytical conditions

A high sensitivity triple quadrupole system LCMS-8060, which is coupled with a Nexera UHPLC system, was employed in this study. A biphenyl column obtained from Phenomenex was used, which is described with features of enhanced selectivity and aqueous stability. A gradient elution program was developed for the five artificial sweeteners. The details of UHPLC and MS/MS conditions are compiled into Table 1.

##### Preparation of standards and samples

Stock solutions of the five artificial sweetener standards were prepared from powder chemicals in pure methanol. A mixed standard was prepared from the stocks and was diluted in series using Milli-Q water to 1, 5, 20, 50, 100, 250, 500 and 1000 ng/L as calibrants. The testing samples were obtained from a third-party laboratory, including treated water and local reservoir sampling water samples and a few spiked samples as controls. All the waters samples were injected to LC/MS/MS without any pre-treatment or enrichment.

Table 1: Analytical conditions of artificial sweeteners on LCMS-8060

|                        |  |
|------------------------|--|
| <b>Column</b>          | Kinetex 2.6µm Biphenyl 100Å (100 mm L. x 2.10mm I.D.)  |
| <b>Mobile Phase</b>    | A: Water<br>B: Methanol  |
| <b>Elution Program</b> | Gradient elution, 1%B (0.0-0.5 min), 30%B (1.5-2.0 min), 80%B (3.5-4.5 min), 1%B (4.6-6.0 min) |
| <b>Flow Rate</b>       | 0.3 mL/min   |
| <b>Oven Temp.</b>      | 40 °C  |
| <b>Injection</b>       | 10 µL  |
| <b>Interface</b>       | ESI Heated by heating gas  |
| <b>MS Mode</b>         | MRM, Positive and Negative mode  |
| <b>Block Temp.</b>     | 500 °C   |
| <b>DL Temp.</b>        | 300 °C   |
| <b>Interface Temp.</b> | 400 °C   |
| <b>Nebulizing gas</b>  | N <sub>2</sub> , 3 L/min   |
| <b>Drying gas</b>      | N <sub>2</sub> , 0 L/min   |
| <b>Heating Gas</b>     | Zero air, 20 L/min   |

#### □ Results and Discussion

##### A. High sensitivity MRM method for artificial sweeteners

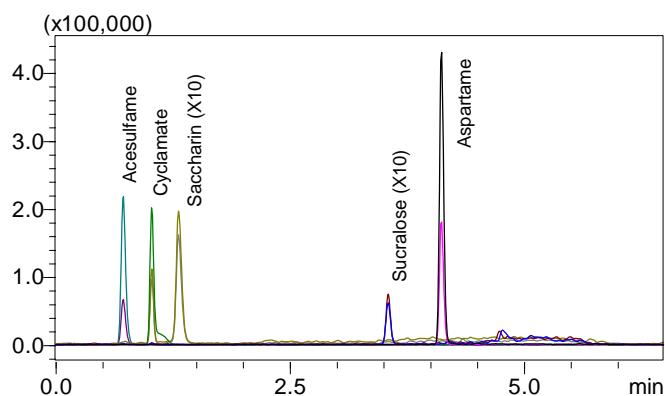
The MRM transitions of the five artificial sweeteners optimized on LCMS-8060 are shown in Table 2. Acesulfame (ACE), cyclamate (CYC) and saccharin (SAC) are ionized in negative ESI/MRM mode, which is in accordance with that was reported in literatures [2-3]. For sucralose (SUC) and aspartame (ASP), positive ESI/MRM mode was used, because it gave better sensitivity and fragmentation spectrum. It was also reported by Noora Perkola et al. [4] that the positive MRM of sucralose is more sensitive than that of negative ESI/MRM mode. The parent ion of sucralose (SUC) in positive mode is sodium adduct ion m/z419.1, which produces two main product ions of m/z239 and m/z221.

With a fast gradient program, the five artificial sweeteners are eluted as sharp peaks as illustrated in Figure 1. Linear calibration curves were established based on quantifying MRMs of the five artificial sweeteners. The calibration curves and performance information of the quantitation method are shown in Figure 1 and Table 2.



**Table 2:** Summary of MRM transitions, retentions, calibration and sensitivity for five artificial sweeteners on LCMS-8060 with 10  $\mu$ L injection

| Compound (Abbr.) | Chemical Formula   | MRM Transitions & Parameter |               |        |                    | RT, Calibration and Sensitivity |              |                          |            |            |            |
|------------------|--|-----------------------------|---------------|--------|--------------------|---------------------------------|--------------|--------------------------|------------|------------|------------|
|                  |  | Precursor (m/z)             | Product (m/z) | CE (V) | Relative Intensity | RT (min)                        | Range (ng/L) | Linearity R <sup>2</sup> | LOD (ng/L) | LOQ (ng/L) | %RSD (n=3) |
| Acesulfame (ACE) | C <sub>4</sub> H <sub>5</sub> NO <sub>4</sub> S                | 162.1                       | 82.1          | 16     | 100                | 0.86                            | 5 – 1000     | 0.9994                   | 0.27       | 0.82       | 2.6        |
|                  |  |                             | 78.0          | 32     | 29                 |                                 |              |                          |            |            |            |
| Cyclamate (CYC)  | C <sub>6</sub> H <sub>13</sub> NO <sub>3</sub> S               | 178.1                       | 79.9          | 26     | 100                | 1.03                            | 5 – 1000     | 0.9968                   | 1.1        | 3.4        | 4.7        |
|                  |  |                             | 95.6          | 20     | 8                  |                                 |              |                          |            |            |            |
| Saccharin (SAC)  | C <sub>7</sub> H <sub>5</sub> NO <sub>3</sub> S                | 182.0                       | 105.8         | 18     | 100                | 1.66                            | 5 – 1000     | 0.9978                   | 2.5        | 7.5        | 5.1        |
|                  |  |                             | 41.9          | 24     | 112                |                                 |              |                          |            |            |            |
| Sucralose (SUC)  | C <sub>12</sub> H <sub>19</sub> Cl <sub>3</sub> O <sub>8</sub> | 419.1                       | 239.0         | -21    | 100                | 3.56                            | 20 – 1000    | 0.9986                   | 30.6       | 92.7       | 9.2        |
|                  |  |                             | 220.9         | -21    | 90                 |                                 |              |                          |            |            |            |
| Aspartame (ASP)  | C <sub>14</sub> H <sub>18</sub> N <sub>2</sub> O <sub>2</sub>  | 295.1                       | 120.0         | -27    | 100                | 4.12                            | 1 – 1000     | 0.9995                   | 0.99       | 3.0        | 1.7        |
|                  |  |                             | 180.0         | -15    | 41                 |                                 |              |                          |            |            |            |



**Figure 1:** MRM chromatogram of five artificial sweeteners of a mixed standard of 500 ng/L on LCMS-8060 with 10  $\mu$ L injection.

**B. Analyses of treated water and reservoir water**

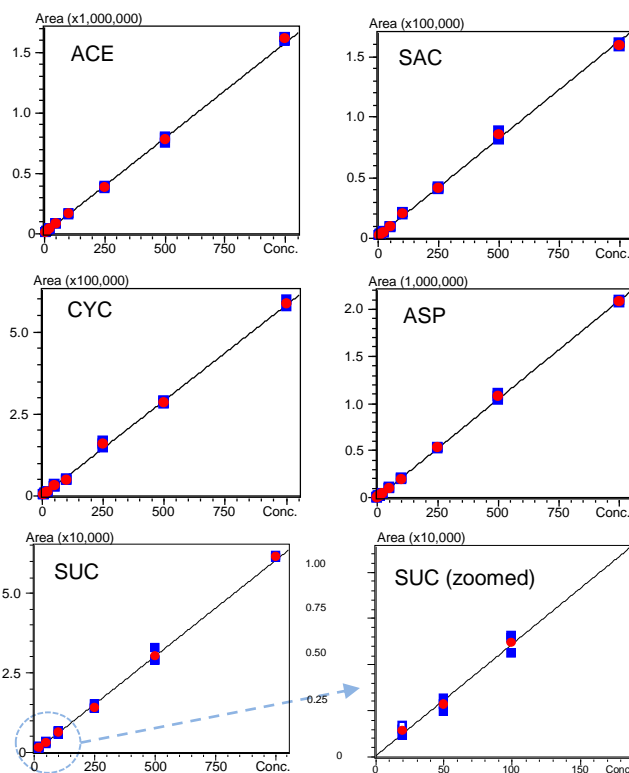
The MRM method established was applied for screening and quantitation of the targeted artificial sweeteners in treated water (S1) and reservoir water (S2) samples. The samples were analyzed with an injection of 10  $\mu$ L and without any pre-treatment or sample enrichment. In addition, two spiked diluents (Milli-Q water) at low and high concentrations as controls (C/L and C/H) prepared by a third-party laboratory were also analyzed with the method. The analysis results are shown in Table 3.

**Table 3:** Results of five artificial sweeteners in water samples\* by direct MRM method on LCMS-8060.

| Compd | RT   | C (L) | C (H) | S1   | S2   |
|-------|------|-------|-------|------|------|
| ACE   | 0.77 | 20    | 130   | 2.1  | 12   |
| CYC   | 1.03 | 21    | 74    | 65   | 52   |
| SAC   | 1.16 | 69    | 149   | 32   | 89   |
| SUC   | 3.06 | 36    | 153   | N.D. | 34   |
| ASP   | 4.12 | 3     | 92    | N.D. | N.D. |

\* S1: Treated water, S2: Reservoir water, N.D.: Not Detected

The LODs of the method for the target artificial sweeteners are better than 2.5 ng/L, except for sucralose (SUC). The individual MRM peaks of mixed standards and reservoir sample (S1) are displayed in Figure 3. It can be seen that the peak intensity of SUC is relatively low in comparison with the other four compounds. The analysis results were based on an

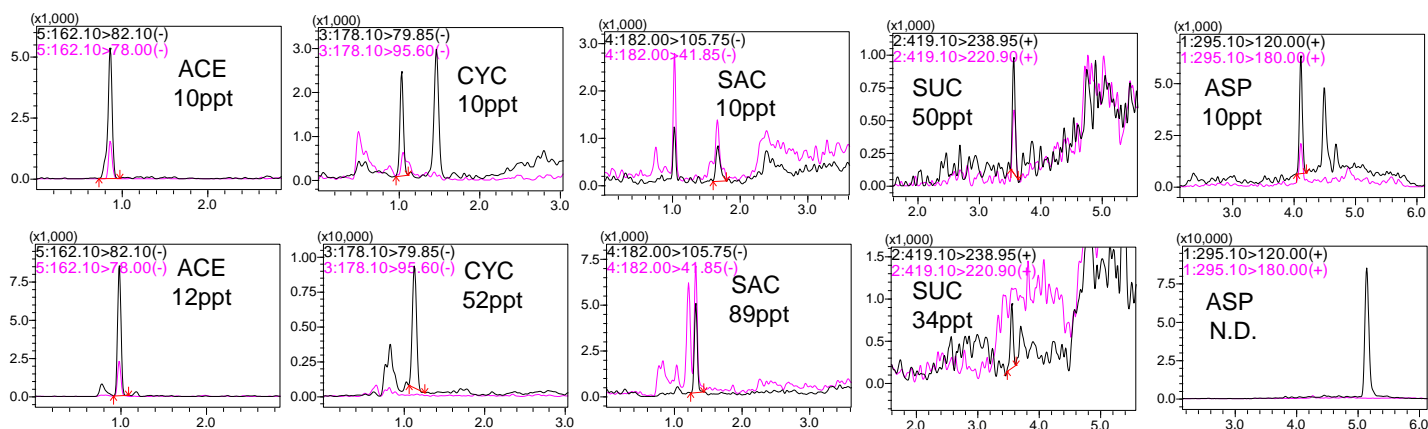


**Figure 2:** Calibration curves of five artificial sweetener standards in MRM mode on LCMS-8060 with 10  $\mu$ L injection.

injection volume of 10  $\mu$ L. With an increased injection volume of 30  $\mu$ L, the sensitivity of the method is expected to increase to be able to achieve a LOD of 10 ng/L for SUC.

**Conclusions**

A LC/MS/MS method with fast gradient elution of 6 minutes was established and applied in detection and quantitation of five artificial sweeteners, acesulfame (ACE), cyclamate (CYC), saccharin (SAC), sucralose (SUC) and aspartame (ASP), in surface water samples. Without any sample pre-treatment or enrichment, the LODs of the method have achieved the level of low ng/L. This results indicate the possibility to apply the method for direct analysis of the target artificial sweeteners in surface waters and drinking waters without the need of sample enrichment.



**Figure 3:** Individual MRM chromatograms of five artificial sweeteners on LCMS-8060 with Injection volume of 10  $\mu$ L. Top: standards in Milli-Q water; Bottom: reservoir water sample.

## References

1. Frank. T. Lange, Marco Scheurer, Heinz-J. Brauch, Anal Bioanal Chem (2012) 403: 2503-2518.
2. Marco Scheurer, Florian R. Stock, Heinz-J. Brauch and Frank. T. Lange, Water Research 44 (2010) 3573-3584.
3. Douglas B. Mawhinney, Robert B. Young, Brett J. Vanderford, Thomas Borch and Shane A. Snyder, Environ. Sci. Technol, 2011, 45, 8716-8722.
4. Noora Perkola, Pirjo Sainio, Environmental pollution 184 (2014) 391-396.
5. Jie Xing, Wantung Liw, Zhi Wei Edwin Ting, Yin Ling Chew and Zhaoqi Zhan, "Highly sensitive and robust LC/MS/MS method for quantitative analysis of artificial sweeteners in beverages", ASMS 2014, PM351

**Disclaimer:** The data and instruments presented in this Application News are intended for Research Use Only (RUO). Not for use in diagnostic procedures.

# Application News

## No. AD-0127

### Water Analysis / LCMS-8060

## A Highly Sensitive MRM-Based Method for Detection and Quantitation of Seven Pharmaceuticals and Personal Care Products (PPCPs) in Surface Water

### □ Introduction

The presence of pharmaceutical and personal care products (PPCPs) in drinking water has become a growing public concern due to their continuous input and persistence to the environment [1,2]. They include many drug compounds from medicines and chemical ingredients from daily personal care products such as soaps, toothpastes and cosmetics. Many PPCPs act as endocrine disruptors and thus altering the normal functions of hormones resulting in reproductive defects and health issues [2]. The main sources of PPCPs in surface water are wastewaters from industries and domestic sewages. It has been reported that the levels of PPCPs in sewage treatment plants are in the range of low ng/L to µg/L. Risk assessments of PPCPs are evaluated, and regulations for control and management of PPCPs into surface water have been established in many countries [1,2]. For monitoring PPCPs in surface water and wastewater, mass spectrometry methods on LC-Q-TOF and triple quadrupole LC/MS/MS are used widely for their high sensitivity and superior identification capability [3,4]. To ensure the sensitivity for detection of low ng/L level or parts per trillion (ppt), off-line or on-line pre-concentration of water samples is often required [5]. In this Application News, a highly-sensitive LC/MS/MS method is described, which has been developed on a high sensitivity model of triple quadrupole LCMS-8060, aiming at direct determination of seven PPCPs (see Table 2) of low ppt levels in surface water samples like treated water and reservoir water without pre-concentration.

### □ Experimental

#### Analytical conditions and sample preparation

A LCMS-8060 triple quadrupole system coupled with Nexera UHPLC was employed in this work. A pentafluorophenyl (PFP) column from Phenomenex was used and a fast gradient elution program was optimized for analysis of the seven PPCPs. Details of the UHPLC conditions and MS/MS parameters are shown in Table 1. Stock solutions of the seven PPCPs standards (see Table 2) were prepared and diluted in series with Milli-Q water to obtain calibrants. A treated water sample (S1) from a wastewater treatment, a reservoir water sample (S2) and a few control samples were obtained from a third-party laboratory. These water samples were analyzed by injecting into the LC/MS/MS directly without any sample pre-treatment or enrichment.

**Table 1:** Analytical conditions of PPCPs on LCMS-8060

|                        |   |
|------------------------|---|
| <b>Column</b>          | Kinetex 2.6u PFP 100A (100 mm L. x 2.10mm I.D.)   |
| <b>Mobile Phase</b>    | A: Water 0.1% formic acid<br>B: Acetonitrile  |
| <b>Elution Program</b> | Gradient elution, 5%B (0.00-0.50 min), 75%B (4.54 min), 95% B (4.55-6.50min), 5%B (6.60-8.00 min) |
| <b>Flow Rate</b>       | 0.3 mL/min  |
| <b>Oven Temp.</b>      | 40°C  |
| <b>Injection</b>       | 10 µL   |
| <b>Interface</b>       | ESI Heated  |
| <b>MS Mode</b>         | MRM, Positive and Negative mode   |
| <b>Block Temp.</b>     | 400°C   |
| <b>DL Temp.</b>        | 250°C   |
| <b>Interface Temp.</b> | 300°C   |
| <b>Nebulizing gas</b>  | N <sub>2</sub> , 3.0 L/min  |
| <b>Drying gas</b>      | N <sub>2</sub> , 5.0 L/min  |
| <b>Heating Gas</b>     | Zero air, 15.0 L/min  |

### □ Results and Discussion

#### A. Highly sensitive MRM method for seven PPCPs

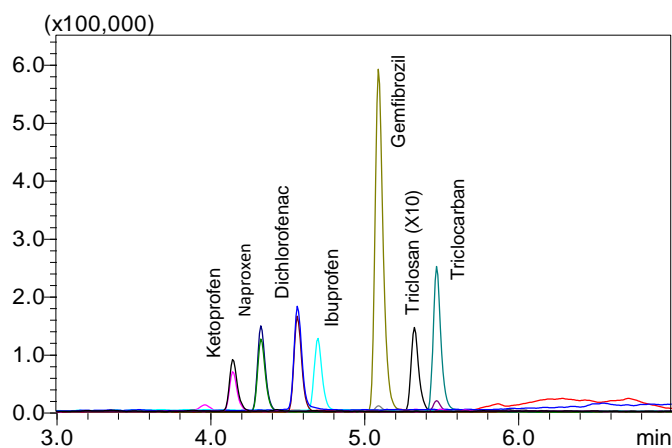
The seven PPCPs used in this study include four nonsteroidal anti-inflammatory drugs, one fibrate drug and two antibacterial agents. The compound names and information are compiled into Table 2. The two antibacterial agents, dichlorofenac and triclosan, are commonly used in personal care products such as toothpaste, soaps, detergents and lotions. MRM optimization of the compounds were performed and two MRM transitions for each compound were selected with one for quantitation and the other for confirmation. However, as shown in Table 2, the relative intensities of the reference MRM transitions of four compounds are very low at 2%~8%, which has significant limitations as confirmation of the compounds at low concentration levels.

**Table 2:** Summary of MRM transitions, calibration range, linearity and detection sensitivity of seven PPCPs on LCMS-8060

| Compound Name & Formula  | Type of PPCP           | MRM Parameter |          |        |           | Quantitation Method |              |                |            |            |             |
|--|------------------------|---------------|----------|--------|-----------|---------------------|--------------|----------------|------------|------------|-------------|
|  |                        | Precursor     | Product  | CE (V) | Intensity | RT (min)            | Range (ng/L) | R <sup>2</sup> | LOD (ng/L) | LOQ (ng/L) | %RSD (n=3)* |
| Ketoprofen (C <sub>16</sub> H <sub>14</sub> O <sub>3</sub> )                     | Anti-inflammatory drug | 255.0         | 105.1    | -23    | 100       | 4.15                | 10~1000      | 0.9998         | 13.5       | 38.5       | 4.1         |
|  |                        |               | 77.1     | -47    | 76        |                     |              |                |            |            |             |
| Naproxen (C <sub>14</sub> H <sub>14</sub> O <sub>3</sub> )                       | Anti-inflammatory drug | (-)229.2      | (-)170.1 | 15     | 100       | 4.31                | 5~500        | 0.9963         | 2.2        | 6.7        | 7.2         |
|  |                        |               | (-)169.1 | 32     | 84        |                     |              |                |            |            |             |
| Ibuprofen (C <sub>13</sub> H <sub>18</sub> O <sub>2</sub> )                      | Anti-inflammatory drug | (-)205.2      | (-)161.3 | 9      | 100       | 4.70                | 10~500       | 0.9962         | 9.0        | 27.2       | 6.1         |
|  |                        |               | (-)117.1 | 22     | 2         |                     |              |                |            |            |             |
| Gemfibrozil (C <sub>15</sub> H <sub>22</sub> O <sub>3</sub> )                    | Fibrate Drug           | (-)249.2      | (-)121.1 | 20     | 100       | 5.10                | 1~500        | 0.9960         | 1.0        | 2.9        | 3.9         |
|  |                        |               | (-)106.1 | 43     | 2         |                     |              |                |            |            |             |
| Dichlorofenac (C <sub>14</sub> H <sub>11</sub> Cl <sub>2</sub> NO <sub>2</sub> ) | Anti-inflammatory drug | 296.1         | 215.0    | -21    | 100       | 4.57                | 5~1000       | 0.9995         | 4.7        | 14.2       | 3.0         |
|  |                        |               | 214.0    | -33    | 96        |                     |              |                |            |            |             |
| Triclocarban (C <sub>13</sub> H <sub>9</sub> Cl <sub>3</sub> N <sub>2</sub> O)   | Antibacterials         | (-)313.1      | (-)160.1 | 14     | 100       | 5.47                | 5~500        | 0.9924         | 2.2        | 6.8        | 1.7         |
|  |                        |               | (-)126.1 | 23     | 8         |                     |              |                |            |            |             |
| Triclosan (C <sub>12</sub> H <sub>7</sub> Cl <sub>3</sub> O <sub>2</sub> )       | Antibacterials         | (-)287.0      | (-)35.1  | 10     | 100       | 5.33                | 10~500       | 0.9936         | 6.1        | 18.9       | 7.3         |
|  |                        |               | (-)142.0 | 35     | 6         |                     |              |                |            |            |             |

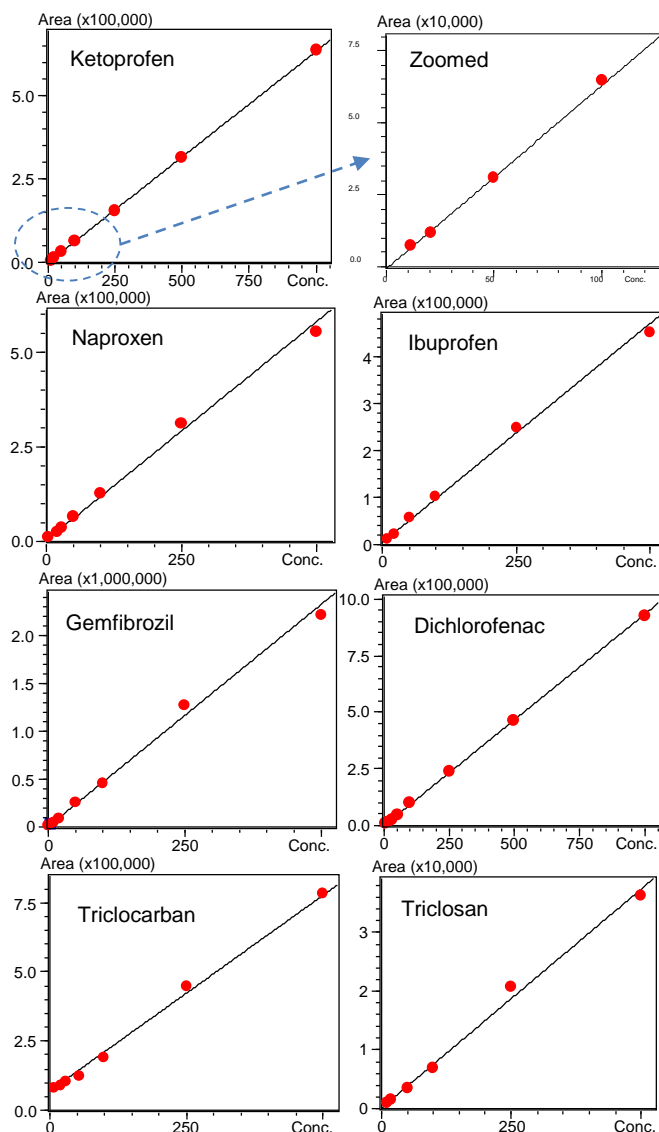
\* At concentrations nearest LOQs

A gradient elution of 8 minutes was optimized and MRM chromatograms of the seven compounds are illustrated in Figure 1. Based on the quantifying MRM transitions, linear calibration curves were established using the calibrant series of 1, 5, 10, 20, 50, 100, 250, 500 and 1000 ng/L in pure water. The calibration curves constructed with weighting method of 1/C are shown in Figure 2. The range and linearity (coefficient R<sup>2</sup>) of the method are summarized in Table 2.

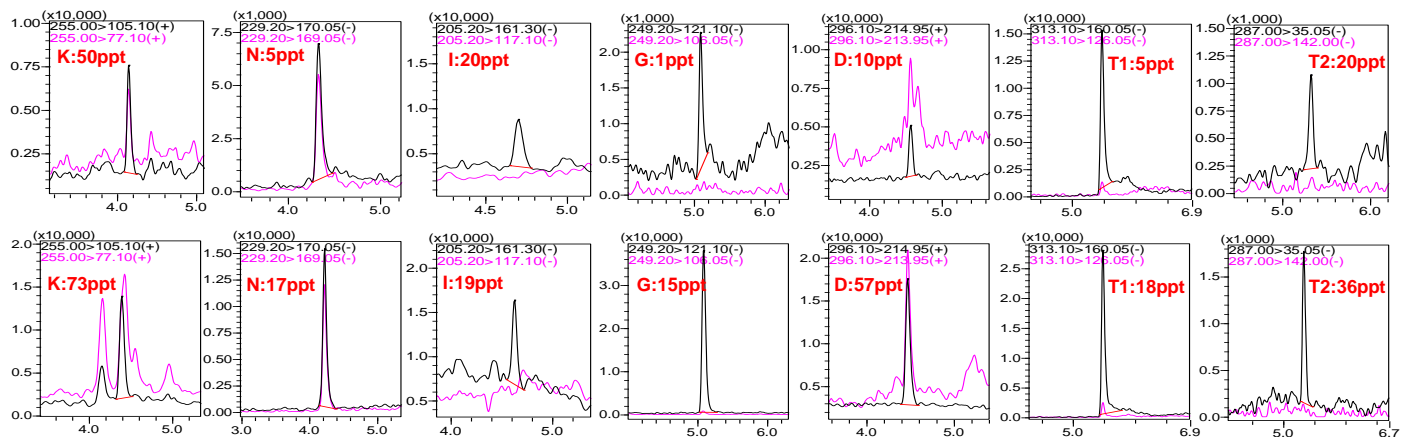


**Figure 1:** MRM chromatograms of seven PPCPs in a mixed standard sample of 500 ng/L.

Furthermore, the repeatability of the quantitation method at the levels nearest to the LOQs of every compounds are determined with triplicate injections (n=3). As can be seen in Table 2, the %RSD falls in a range of 1.7%~7.2%, indicating that the quantitation method is very repeatable and reliable. The LODs and LOQs of the method were estimated from the results of the lowest concentration standards following the rules of S/N ≥10 for determining LOQs and S/N ≥3 for LODs. The LODs obtained with an injection of 10 μL are 1.0 ng/L for gemfibrozil, 2.2 ng/L for naproxen and triclocarban, 4.7~9.0 ng/L for dichlorofenac, triclocarban and ibuprofen, and 13.5 ng/L for ketoprofen.



**Figure 2:** Calibration curves of seven PPCP standards by MRM method on LCMS-8060 with an injection volume of 10 μL.



**Figure 3:** A comparison of individual MRM peaks of seven PPCPs spiked in Milli-Q water at nearest LOQ levels (Top) and in the reservoir water sample S4 (Bottom) at few tens ng/L (ppt).

## B. Analysis of treated water and reservoir water

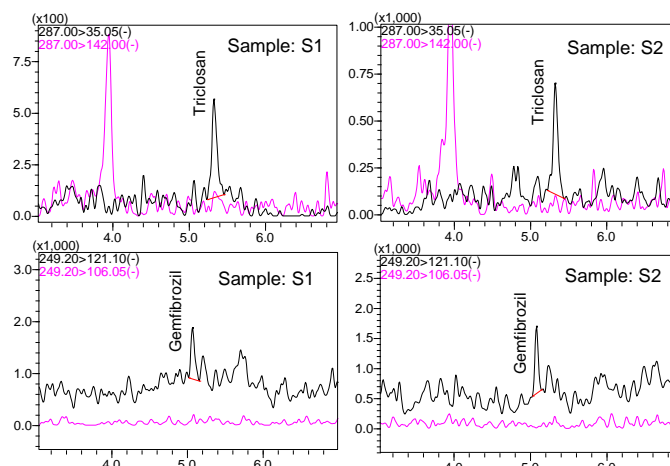
The MRM method established was applied to several surface water samples. Sample S1 is a treated water from sewage treatment unit and S2 is a reservoir water from a local source. In addition, spiked samples S3 and S4 were prepared by a third-party laboratory, which were used for verification of the detection and quantitation reliability of the method without pre-concentration or enrichment of the samples.

**Table 3:** Quantitation results of PPCPs in water samples. (N.D. = Not Detected)

| Name (Abbr.)      | RT (min) | Determined Concentration (ng/L) |      |      |      |
|-------------------|----------|---------------------------------|------|------|------|
|                   |          | S1                              | S2   | S3   | S4   |
| Ketoprofen (K)    | 4.15     | N.D.                            | N.D. | 55.4 | 72.9 |
| Naproxen (N)      | 4.31     | N.D.                            | N.D. | 33.5 | 17.0 |
| Ibuprofen (I)     | 4.70     | N.D.                            | N.D. | 36.4 | 19.1 |
| Gemfibrozil (G)   | 5.10     | 0.54                            | 0.49 | 36.6 | 14.5 |
| Dichlorofenac (D) | 4.57     | N.D.                            | N.D. | 53.9 | 56.5 |
| Triclocarban (T1) | 5.47     | N.D.                            | N.D. | 34.0 | 18.2 |
| Triclosan (T2)    | 5.33     | 10.9                            | 10.9 | 64.8 | 35.9 |

Milli-Q water was used as blank and always injected before every water samples to confirm a clean baseline and free of sample carryover. The analysis results shown in Table 3 indicate that the two water samples S1 and S2 are free of the targeted PPCPs except triclosan, which the concentrations are 10.9 ng/L (Figure 4, top). A very small peak of gemfibrozil was observed (Figure 4, bottom) and the corresponding level is about 0.5 ng/L, which is below the LOD of the method. Thus, its presence in the samples is suspected only. The individual MRM peaks of the spiked sample S4 are compared with those of mixed standards in Milli-Q water in Figure 3, which is served as a reference verification of the method for detection and quantitation of the seven targets.

**Disclaimer:** The data and instruments presented in this Application News are intended for Research Use Only (RUO).



**Figure 4:** Triclosan peak (top) and gemfibrozil (bottom) in treated water (S1) and reservoir water (S2).

## □ Conclusions

A high sensitivity MRM method for quantitative determination of seven PPCPs in water samples was developed. Without sample pre-concentration or enrichment, the LODs of the MRM method achieved are 1.0 ng/L for gemfibrozil, 2.2 ng/L for naproxen, triclocarban and Ibuprofen, 4.7–9.0 ng/L for dichlorofenac and triclosan, and 13.5 ng/L for ketoprofen.

## □ References

1. U.S. EPA Method 1694: *Pharmaceuticals and Personal Care Products in Water, Soil, Sediment and Biosolids by LC/MS/MS* (2007).
2. Liu J, Wong M, "Pharmaceuticals and personal care products: A review on environmental contamination in China", *Env Int.* 59 (2013): 208-224.
3. Angela L. Batt, Mitch S. Kostich and James M. Lazorchak, "Analysis of Ecologically Relevant Pharmaceuticals in Wastewater and Surface Water Using Selective Solid-Phase Extraction and UPLC-MS/MS", *Anal. Chem.*, 2008, 80 (13), 5021–5030.
4. Katie Pryor, Jerry Byrne, Rachel Lieberman, Christopher Gilles, "LCMS-MS Method for Evaluation of PPCPs in Environmental Water", ASMS-2016, MP169 (PO-CON1659E), 2016
5. Jie Xing, Jingming Wu, Li Feng Zhang, Peiting Zeng, Sandhya Nargund, Zhaoqi Zhan, "A Fully Automated Multiple Injection On-line SPE-LC-MS/MS Method for Analysis of Trace Level Drug Residues in Water", ASMS-2012.

# Application News

## No. A503

### Spectrophotometric Analysis

## Quality Analysis of Environmental Water

- Using a Water Analysis Program Designed for the UV-1280 -

In the environmental sector, regulations are in place and monitoring is performed on the quantities of specific substances present in industrial wastewater and river water. An increase in the concentration of phosphorus and nitrogen in river water can cause abnormal growth of algae and phytoplankton.<sup>1)</sup> Japan uses river water among other sources for its tap water, which is treated to make it potable.<sup>2)</sup> There are 51 "water quality criteria" and 26 "water control targets" prescribed for tap water in Japan.<sup>3)</sup> These criteria and targets include prescriptions for parameters such as residual chlorine and hardness, which are items of relatively common concern.

We developed a water analysis program designed for use with the UV-1280 UV-VIS spectrophotometer, which provides easy analysis of 22 substances and 39 items (including phosphoric acid and residual chlorine) by mainly using the "PACKTEST" water quality testing kits from Kyoritsu Chemical-Check Lab., Corp.

We describe using this UV-1280 water analysis program to analyze day-to-day changes in phosphate-phosphorus levels in river water and residual chlorine, iron, and total hardness levels in tap water.

### ■ Analysis of Phosphate Phosphorus in River Water

The UV-1280 and a Kyoritsu Chemical-Check Lab., Corp. PACKTEST are shown in Fig. 1. The water analysis program displays the measurement procedure on-screen. An example procedure is shown in Fig. 2. The program also has built-in calibration curves created with standard samples, so concentration measurements can be made simply by following the on-screen instructions. New measurement items can also be added using a User-Defined Items function, and a trend graphing function can be used to show day-to-day changes in a single view.

River water (hereinafter river water A) was taken from a local river alongside weather recordings between February 15 and 26, 2016, and phosphate phosphorus measurements were made using the measurement conditions shown in Table 1.

The trend graph shown in Fig. 3 allows the user to understand day-to-day changes in the phosphate phosphorus concentration in river water A at a single glance. The phosphate phosphorus concentration was below the lower limit of detection (0.04 mg/L) on most days, while a maximum concentration of 0.398 mg/L was detected on February 16. Rainfall was observed close to the river water collection point on February 14 and 20, which probably caused the low levels of phosphate phosphorus detected on February 15, 16, and 22.

A photograph of the river water collection point is shown in Fig. 4. The photograph shows the water was clean and the riverbed was fully visible on sunny days.



Fig. 1 UV-1280 and PACKTEST

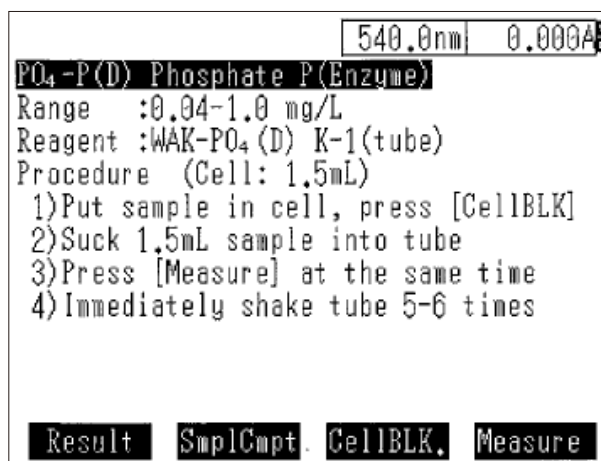


Fig. 2 Phosphate Phosphorus Measurement Procedure (Enzymatic Method)

Table 1 Measurement Conditions

|                  |   |
|------------------|---|
| Instruments used | UV-1280                                   |
|                  | Water analysis program                    |
|                  | PACKTEST Phosphate-Phosphorus (Low Range) |
| Items measured   | Phosphate phosphorus (enzymatic method)   |

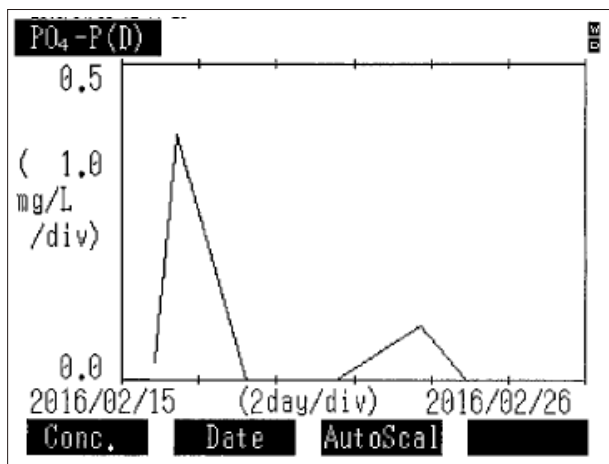


Fig. 3 Phosphate Phosphorus over Time (Trend Graph)

### Quality Analysis of Tap Water

Tap water contains substances such as residual chlorine, mineral content in the form of calcium and magnesium that is represented as total hardness, and iron. The prescribed water quality criteria levels for these items are  $\geq 0.1$  mg/L for residual chlorine,  $\leq 300$  mg/L for total hardness, and  $\leq 0.3$  mg/L for iron in Japan.

We collected tap water from a normal tap, a tap with water purifier attached, and a tap that is rarely used, and measured the above three items under the measurement conditions shown in Table 2.

The water samples before and after testing are shown in Fig. 5, and the test results are shown in Table 3. A small amount of residual chlorine was found in tap water that passed through a water purifier, but no residual chlorine was detected in tap water taken from the tap that was rarely used. We suspected some degradation of the water purifier. Probable reasons that residual chlorine was not detected in water taken from the tap that is rarely used are stagnation of water in the pipes and aging of the pipes themselves. Total hardness concentrations were within the water quality criteria levels and within the target levels (10 to 100 mg/L) in water taken from all three taps. Iron was only detected at 0.165 mg/L in water taken from the tap that was rarely used. Water taken from the tap that was rarely used appeared colored compared to other tap waters, and we inferred the iron present in the water originated from the pipes.

Table 2 Measurement Conditions

|                  |   |
|------------------|---|
| Instruments used | : UV-1280<br>Water analysis program<br>PACKTEST Residual Chlorine (free),<br>Total Hardness, Iron (low range) |
| Items measured   | : Residual chlorine (free), total hardness,<br>iron (low range)   |



Fig. 4 River at Collection Point

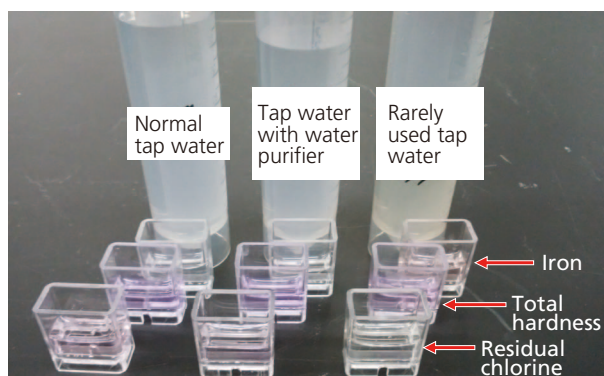


Fig. 5 Left: Normal Tap Water, Middle: Tap Water with Water Purifier, Right: Rarely Used Tap Water

Table 3 Measurement Results

|                          | Normal      | With water purifier | Rarely used tap water |
|--------------------------|-------------|---------------------|-----------------------|
| Residual chlorine (free) | 0.18 mg/L   | 0.07 mg/L           | < 0.05 mg/L           |
| Total hardness           | 40 mg/L     | 48 mg/L             | 34 mg/L               |
| Iron (low range)         | < 0.05 mg/L | < 0.05 mg/L         | 0.17 mg/L             |

### Conclusion

We easily performed water quality analysis of environmental water and tap water using the water analysis program designed for the UV-1280 and the PACKTEST series of products from Kyoritsu Chemical-Check Lab., Corp. We also used the trend graphing function to observe day-to-day changes in a single view.

### [References]

- 1) Kyoritsu Chemical-Check Lab., Corp. PACKTEST water analysis kit
- 2) Kyoto City Waterworks and Sewerage Bureau website
- 3) Japan's Ministry of Health, Labour and Welfare website

# Application News

## No. A544

### Spectrophotometric Analysis

## Quantitative Analysis of Oil and Grease in Water Using FTIR Based on ASTM D7575

The discharge of oil and grease into water environments such as oceans and rivers is a water quality control issue since it may lead to environmental problems including adverse effects on ecological systems and malodor. A measurement method described in JIS K 0102 "Testing Methods for Industrial Wastewater"<sup>1</sup> that involves determining the quantity of n-Hexane extract is one method for quantifying oil and grease in water. However, there are issues with this method including the necessity of cumbersome pretreatment and the long time required until results are obtained.

This article introduces a quantitative analysis method for oil and grease in water that employs FTIR based on the ASTM D7575 standard.<sup>2</sup> ASTM standards are set and published by ASTM International, which is the world's largest international standardization and standards-setting organization. ASTM D7575 enables quantitation of oil and grease in water with a simple measurement method that utilizes the absorption band of CH groups, thereby eliminating the need for solvent extraction.

R. Fuji

### Overview of Testing Based on ASTM D7575

Testing was performed using the ClearShot Extraction Package<sup>3</sup> manufactured by Orono Spectral Solutions, Inc., shown in Fig. 1. The measurement instrument, testing equipment, reagents used, and contents of the ClearShot Extraction Package are listed below.



Fig. 1 ClearShot Extraction Package

#### <Measurement Instrument and Testing Equipment>

- Fourier transform infrared spectrophotometer
- 1 L glass sample collection bottle
- Ultrasonic cleaner capable of heating to 40 °C and accommodating the 1 L glass sample collection bottle
- 10 mL syringe
- 10 mL and 1 mL measuring pipets
- 100 mL measuring flask

#### <Reagents Used>

- 12.1 M hydrochloric acid  
(The following items are for recovery rate verification.)
- Ion exchange water
- Acetone
- Hexadecane
- Stearic acid

#### <Contents of ClearShot Extraction Package>

- ClearShot™ Extraction Technology cartridges (ClearShot extractors)
- ClearShot Holding Card
- Calibration Standard Devices (CSD) Set
- Drying System

### Calibration Curve Creation

After measuring the background with a new ClearShot extractor, the seven calibration standard devices (CSD) for calibration curve creation were measured using the transmittance mode. A calibration curve was created by setting a baseline between 2990 cm<sup>-1</sup> and 2800 cm<sup>-1</sup> in the obtained infrared spectra and determining the heights of the top peaks from the baseline at 2920 cm<sup>-1</sup>. Table 1 lists the measurement conditions, Fig. 2 shows an enlarged view of peaks around 2920 cm<sup>-1</sup> of the standard samples, and Fig. 3 shows the calibration curve and lists the standard sample concentrations.

Table 1 Measurement Conditions

|                      |                                      |
|----------------------|--------------------------------------|
| Instrument           | : IRTracer-100                       |
| Resolution           | : 4 cm <sup>-1</sup>                 |
| Accumulation         | : (BKG) 200 times, (sample) 64 times |
| Apodization function | : SqrTriangle                        |
| Detector             | : DLATGS                             |

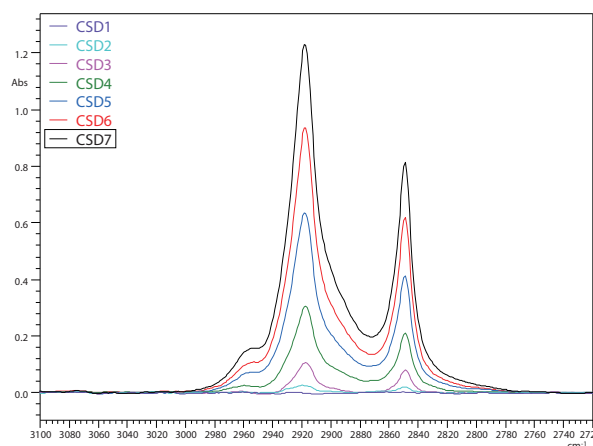
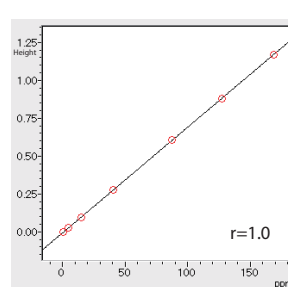


Fig. 2 Enlarged View of Peaks Around 2920 cm<sup>-1</sup>



| Sample | Absorbance | Concentration [ppm] |
|--------|------------|---------------------|
| CSD1   | 0.0020     | 0.73                |
| CSD2   | 0.026      | 4.54                |
| CSD3   | 0.096      | 15.23               |
| CSD4   | 0.28       | 40.56               |
| CSD5   | 0.60       | 87.57               |
| CSD6   | 0.87       | 127.55              |
| CSD7   | 1.2        | 168.70              |

Fig. 3 Calibration Curve and Standard Sample Concentrations

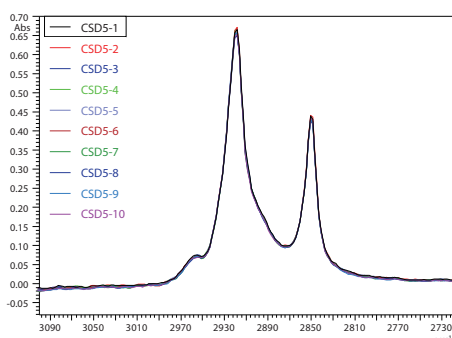


### ■ Checking Repeatability

Repeatability of measurement was checked using standard sample CSD5. Table 2 shows the repeatability measurement results obtained by two different methods: (a) 10 consecutive measurements without removing the cartridge inserted in the sample chamber and (b) 10 measurements by removing and then reinserting the cartridge for each measurement. Fig. 4 shows the infrared spectra obtained from the 10 consecutive measurements. Variation between measurements was low and favorable repeatability was obtained even with the method in which the cartridge was removed.

**Table 2 Repeatability**  
(a) 10 consecutive measurements without removing the sample  
(b) 10 measurements with removal of the sample for each measurement

| Measurement Method | Number of Measurements | Concentration [ppm] | Standard Deviation [ppm] |
|--------------------|------------------------|---------------------|--------------------------|
| (a) No removal     | 10                     | 95.33               | 0.96                     |
| (b) With removal   | 10                     | 94.63               | 0.99                     |



**Fig. 4 Infrared Spectra of Repeated Measurements (10 Consecutive Measurements)**

### ■ Verification of Recovery Rate

The procedure is described below.

<Sample Preparation>

- Put 400 mg  $\pm$ 4 mg of hexadecane and 400 mg  $\pm$ 4 mg of stearic acid into the 100 mL measuring flask.
- Add acetone to prepare a 1:1 solution of hexadecane and stearic acid.
- Use the ion exchange water as a solvent to adjust the solution from step ② to a concentration of 40 ppm.

<Sample Measurement>

- Put about 12 mL of sample into the 10 mL syringe and let it stand for a short while to allow any air bubbles within the sample to escape.
- Filter 10 mL of sample solution using a ClearShot extractor. Then dry the ClearShot extractor holding captured extract by blowing it with compressed air for a few minutes.
- Measure the background with a new ClearShot extractor and then measure the infrared spectrum of the dried ClearShot extractor.
- Calculate the quantitative value using the created calibration curve.

Table 3 lists the verification results of the recovery rates obtained by the above procedure. By comparing the concentrations calculated from the absorbance values and the concentrations of the samples, we obtained recovery rates between 94 % and 107 %.

**Table 3 Recovery Rate Verification Results**

| Sample | Absorbance | Concentration [ppm] |
|--------|------------|---------------------|
| 1      | 0.28       | 41.22               |
| 2      | 0.25       | 37.65               |
| 3      | 0.29       | 42.09               |
| 4      | 0.29       | 42.88               |

### ■ Quantitative Analysis of Oil and Grease in Water

The procedure is described below.

<Sample Preparation>

- Put the measurement sample into the glass sample collection bottle and adjust to pH 2 by adding the 12.1 M hydrochloric acid.
- Put the sample collection bottle into the ultrasonic cleaner heated to 40 °C and leave it for 20 minutes.

<Sample Measurement>

- Put about 12 mL of sample into the 10 mL syringe and let it stand for a short while to allow any air bubbles within the sample to escape.
- Filter 10 mL of sample solution using a ClearShot extractor. Then dry the ClearShot extractor holding captured extract by blowing it with compressed air for a few minutes.
- Measure the background with a new ClearShot extractor and then measure the infrared spectrum of the dried ClearShot extractor.
- Calculate the quantitative value using the created calibration curve.

Quantitative analysis was performed on three samples by the above procedure. Table 4 shows the results.

**Table 4 Measurement Conditions**

| Sample | Absorbance | Concentration [ppm] |
|--------|------------|---------------------|
| 1      | 0.15       | 22.84               |
| 2      | 0.49       | 72.70               |
| 3      | 0.79       | 115.14              |

### ■ Conclusion

The analysis method for oil and grease in water based on the ASTM D7575 standard allows simple and fast quantitation in the order of ppm without the need for solvent extraction. In this Application News, we confirmed that by using Shimadzu's FTIR and the ClearShot Extraction Package manufactured by Orono Spectral Solutions, Inc., calibration curve creation, repeatability checking, recovery rate verification, and actual quantitation of oil and grease can be done easily based on the ASTM D7575 standard.

References:

- \*1 JIS K 0102 "Testing Methods for Industrial Wastewater"
- \*2 ASTM D-7575 -Standard Test Method for Solvent-Free Membrane Recoverable Oil and Grease by Infrared Determination-
- \*3 The ClearShot Extraction Package complies with the ASTM D7575 standard. Clearshot Extraction Technology is a registered trademark of Orono Spectral Solutions, Inc.  
<http://www.ossmaine.com/>

Caution 1) The ClearShot Extraction Package is not sold by Shimadzu. Please purchase it directly from Orono Spectral Solutions, Inc.

Caution 2) The cartridges included in the ClearShot Extraction Package cannot be fitted to the standard cassettes of the IRTTracer-100 and IRAffinity-1S. For details, contact your Shimadzu representative.

# Application News

## No. A495

### Spectrophotometric Analysis

## Measurement of Arsenic and Selenium in White Rice and River Water by Hydride Generation-Atomic Absorption Spectrometry (HG-AAS) with Electric Cell Heating

### ■ Introduction

The hydride generation method is known as a technique for high-sensitivity measurement of elements such as arsenic (As) and selenium (Se), based on the fact that at ambient temperature such elements react with newly generated active hydrogen to generate hydrogen gas compounds. Because it is not easily affected by alkaline metals, alkaline earth metals, and other elements coexisting in samples, it is often used for high-sensitivity measurement of As, Se, and other elements in the environment, foods, and other samples, not only in atomic absorption spectrometry, but also in ICP atomic emission spectrometry, ICP mass spectrometry, and other methods.

The method commonly used for atomic absorption spectrometry involves sending the hydrogen compound gas ( $\text{AsH}_3$  and  $\text{H}_2\text{Se}$ ) generated in a hydride vapor generator into a quartz absorption cell and atomizing the elements by thermal decomposition. Then either a flame or electric heating (furnace) is used to heat the absorption cell.

Electric heating avoids the need for gas supplies required for the flame method (acetylene and air) and offers about 1.5 times higher sensitivity than the flame method for As and Se measurements.

In this example, hydride generation-atomic absorption spectrometry (HG-AAS) with an electric cell heater for heating the absorption cell was used to measure arsenic and selenium in certified white rice reference material (NMIJ CRM 7502-a) and certified river water reference materials (JSAC 0301 with nothing added and JSAC 0302 with As and Se added).

### ■ Pretreatment

#### (1) White Rice

About 1 g of the sample was weighed into a beaker, moistened with a small amount of water, 10 mL of nitric acid was added, and then the sample was thermally decomposed on a hot plate. After the vigorous reaction was finished, 5 mL of nitric acid and 1 mL of perchloric acid were added and thermal decomposition was further continued. After white smoke appeared, the sample was heated to almost dryness and allowed to cool. Then 5 mL of hydrochloric acid (1 + 1) was added to dissolve soluble salts. The result was transferred to a separate container and pure water was added to make 25 mL of the sample stock solution.

Then 10 mL of this sample stock solution was pre-reduced to create 20 mL of the measurement sample. Arsenic was pre-reduced by adding hydrochloric acid, potassium iodide and ascorbic acid and selenium by adding hydrochloric acid to make 20 mL of the measurement solutions.

#### (2) River Water

10 mL was pre-reduced to create 20 mL of the measurement sample, in the same manner as for the white rice.

### ■ System Configuration and Measurement Conditions

The system was configured from an AA-7000 atomic absorption spectrophotometer connected to an HVG-1 hydride vapor generator and SARF-16C atomic muffle furnace (electric cell heater). The cell heater is shown in Fig. 1.

Major measurement conditions are indicated in Table 1.

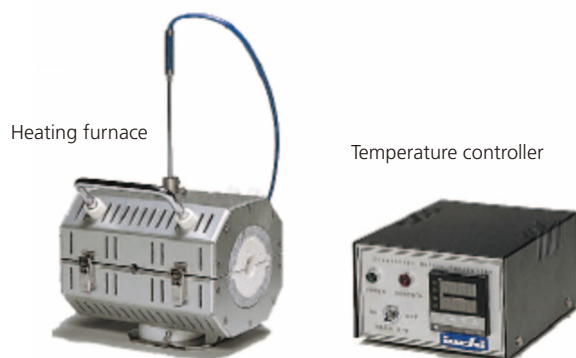


Fig. 1 SARF-16C Atomic Muffle Furnace (Electric Cell Heater)

Table 1 Measurement Conditions

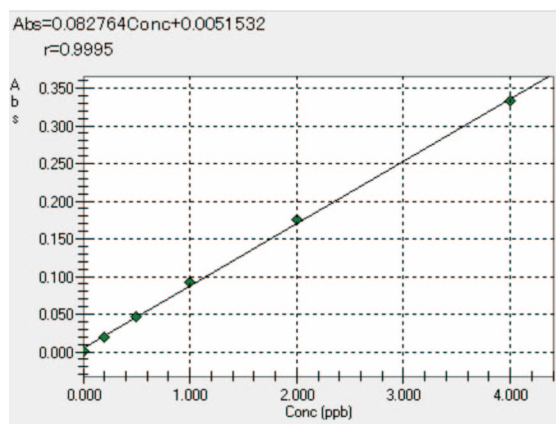
|   | As  | Se       |
|---|---|----------|
| Analytical wavelength                       | 193.7 nm  | 196.0 nm |
| Slit width                                  | 0.7 nm  |          |
| Background correction                       | Deuterium lamp method (D2 method)                                 |          |
| Absorption cell heating system              | Electric heating (800 °C)*  |          |
| Carrier gas                                 | Ar (about 0.1 L/min)  |          |
| Integration time (number of times repeated) | 5 sec (n = 5)   |          |
| Reagent concentration                       | NaBH <sub>4</sub> 0.4 % (NaOH 0.4 %)<br>5 mol/L hydrochloric acid |          |
| Sample delivery rate                        | 4 mL/min (0 to 7 mL/min variable)                                 |          |
| Reagent delivery rate                       | 1.5 mL/min (0 to 2.5 mL/min variable)                             |          |

\* The electric cell heater cannot be installed as a dual-purpose (flame and furnace) unit for the AA-7000 system.

**Analytical Results**

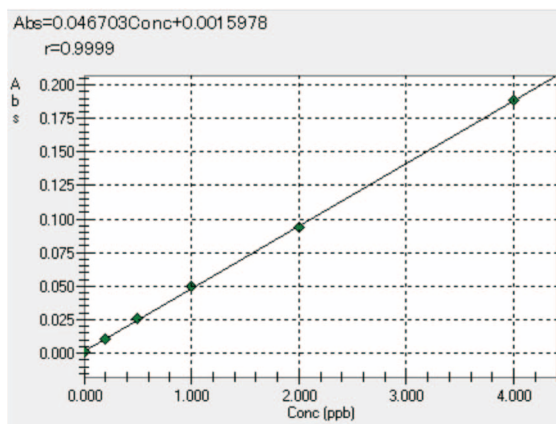
**Calibration Curve and Sensitivity**

Calibration curves for As and Se are shown in Figs. 2 and 3, respectively. As a guideline for the lower limit of detection, a 1 % absorption value (0.0043 Abs) was achieved at a concentration of 0.05 ppb for As and 0.09 ppb for Se in the measurement solution.



| Operation | Sample ID | Concentration Setting (ppb) | Absorbance | %RSD   |
|-----------|-----------|-----------------------------|------------|--------|
| STD-AV    | Blank     | 0.0000                      | 0.0010     | 134.72 |
| STD-AV    | 0.2ppb    | 0.2000                      | 0.0196     | 2.65   |
| STD-AV    | 0.5ppb    | 0.5000                      | 0.0470     | 2.39   |
| STD-AV    | 1ppb      | 1.0000                      | 0.0929     | 1.87   |
| STD-AV    | 2ppb      | 2.0000                      | 0.1747     | 1.23   |
| STD-AV    | 4ppb      | 4.0000                      | 0.3330     | 1.79   |

Fig. 2 Calibration Curve for As



| Operation | Sample ID | Concentration Setting (ppb) | Absorbance | %RSD  |
|-----------|-----------|-----------------------------|------------|-------|
| STD-AV    | Blank     | 0.0000                      | 0.0011     | 78.53 |
| STD-AV    | 0.2ppb    | 0.2000                      | 0.0103     | 17.81 |
| STD-AV    | 0.5ppb    | 0.5000                      | 0.0257     | 4.26  |
| STD-AV    | 1ppb      | 1.0000                      | 0.0495     | 3.12  |
| STD-AV    | 2ppb      | 2.0000                      | 0.0941     | 1.30  |
| STD-AV    | 4ppb      | 4.0000                      | 0.1885     | 2.12  |

Fig. 3 Calibration Curve for Se

**Analytical Results**

Measurement results for white rice are indicated in Table 2 and for river water in Table 3. Results from both samples closely matched respective certified values.

**Table 2 Measurement Results of As and Se in White Rice**

White Rice (NMIJ CRM 7502-a)

| Element                 | As    | Se    |
|-------------------------|-------|-------|
| Certified Value (mg/kg) | 0.109 | –     |
| Measured Value (mg/kg)  | 0.101 | 0.010 |
| %RSD (n = 5)            | 1.7 % | 8.5 % |

**Table 3 Measurement Results of As and Se in River Water**

River Water (JSAC 0301-3 unspiked)

| Element                | As    | Se      |
|------------------------|-------|---------|
| Certified Value (µg/L) | 0.20  | (0.08)* |
| Measured Value (µg/L)  | 0.21  | < 0.2   |
| %RSD (n = 5)           | 7.4 % | –       |

\* Reference value

River Water (JSAC 0302-3 spiked)

| Element                | As    | Se    |
|------------------------|-------|-------|
| Certified Value (µg/L) | 5.2   | 5.0   |
| Measured Value (µg/L)  | 5.1   | 5.3   |
| %RSD (n = 5)           | 1.5 % | 1.0 % |

**Conclusion**

This example shows how an AA-7000 system with electrically heated hydride generation can be used to analyze the arsenic and selenium in food and environmental water with high sensitivity, without the need for gas supplies (acetylene and air) required by flame methods.

## Shimadzu Guide to US EPA Method 624 for Analysis of Volatile Organic Compounds in Wastewater

### ■ Introduction

Environmental contamination has been at the forefront of government policy and regulation since the US EPA was established in 1970. Over the years the US EPA has developed, published, and updated multiple methods for analysis of environmental pollutants, and single-quadrupole gas chromatography-mass spectrometry (GCMS) has long been the technique of choice for determination of volatile organic contaminants (VOCs). As efforts to provide dependable analytical methods have progressed, the GCMS instrumentation has evolved, with improvements in sensitivity, reliability, and user experience, but there haven't been any significant advancements in the overall methodology since the mid-1980s.

The US EPA is currently in the process of developing a revision to US EPA Method 624<sup>1</sup>, which was first promulgated in 1984 and specified the use of packed columns as part of the protocol to collect data on the VOC pollutants. This application note describes a GCMS purge-and-trap (P&T) method validation study conducted to evaluate operating conditions for the existing US EPA Method 624 VOC list, using updated technology and advanced GCMS instrumentation. GCMS instrument operating conditions are provided which bring the method in line with capabilities provided by contemporary laboratory equipment. This application note provides calibration results across three different ranges, complete MDL and Precision and Accuracy studies at multiple concentrations, and analysis of an independent laboratory VOC reference standard and real-world samples.

### ■ Experimental

This study was conducted using the Shimadzu GCMS-QP2010 SE shown in Figure 1, configured with a capillary column designed specifically for analysis of VOCs by US EPA Method 624. The GC was operated in the unique Constant Linear Velocity mode to provide optimum chromatographic resolution, symmetric peak shape, and enhanced sensitivity for all compounds. A special, narrow ID inlet liner was used to minimize band broadening and retain ideal peak shape during transfer from the P&T, while still allowing high-split injections. Data were acquired in the full scan mode; quantitation and confirmation for most compounds were conducted using the quantitation and reference ions suggested in US EPA Method 624. Changes to quantitation and reference ions for a few selected compounds were made to improve overall sensitivity of the method.

The EST Evolution P&T and Centurion Water/Soil Autosampler were used for the extraction, concentration, and sample introduction steps. The Evolution was configured with the optional sample heater to ensure that all samples were purged at precisely the same temperature for accuracy and precision of the data. The Centurion Water/Soil Autosampler was operated in the Water mode for this study; the optional syringe was used for automated dilution of the real-world samples.

Each day before starting a sample sequence, the instrument was conditioned by cycling the P&T and VOCARB 3000 trap through two Bake cycles. Simultaneously, the oven, injection port, ion source, and MS interface temperatures were all raised to 220 °C for a minimum of one hour. The instrument bake-out procedure was run on all days, whether samples were analyzed or not. Complete instrument configuration and operating conditions are shown in Table 1.



Figure 1: Shimadzu GCMS-QP2010 SE

**Table 1:** GCMS and P&T Operating Conditions

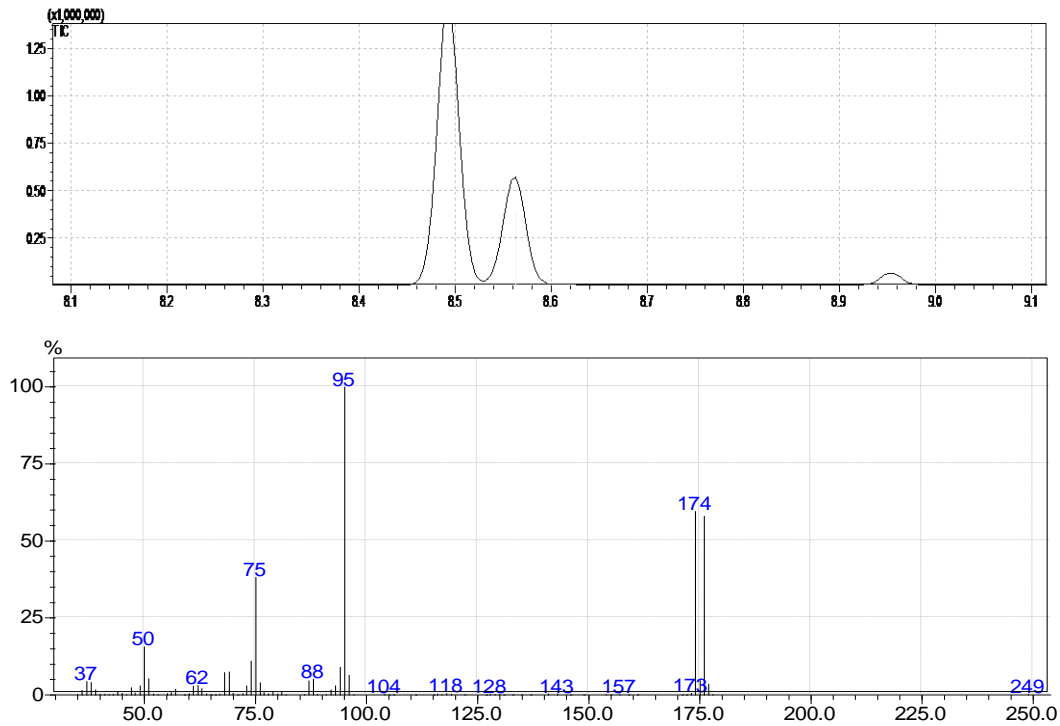
| <b>Gas Chromatograph</b>  |  | <b>GC-2010 Plus</b>                                   |          |        |                                   |           |            |
|---|--|---|----------|--------|-----------------------------------|-----------|------------|
| Column  | SH-RXI-6245il MS, 30 m x 0.25 mm x 1.4 µm (Shimadzu PN 221-75962-30)   |   |          |        |                                   |           |            |
| Oven Program  | 45 °C, hold 0.1 minute<br>15 °C/minute to 220 °C, hold 3.5 minutes   |   |          |        |                                   |           |            |
| Injector  | Split mode, split ratio 40:1<br>200 °C<br>Low volume liner, 0.75 mm ID, straight (Shimadzu PN 220-90784-10)  |   |          |        |                                   |           |            |
| Carrier Gas   | Helium<br>Constant Linear Velocity mode, 36.2 cm/second  |   |          |        |                                   |           |            |
| Interface Temperature   | 180 °C   |   |          |        |                                   |           |            |
| <b>Mass Spectrometer</b>  |  | <b>GCMS-QP2010 SE</b>                                 |          |        |                                   |           |            |
| Ion Source Temperature  | 185 °C   |   |          |        |                                   |           |            |
| MS Operating Mode   | Full scan mode, m/z 35-260<br>Event time = 0.25 second/scan<br>Solvent cut time = 0.7 minute<br>Detector voltage set relative to tune + 0.1 kV<br>Threshold = 100<br>NOTE: The scan rate was adjusted to provide a minimum of 10-12 spectra across all GC peaks for optimum quantitation |   |          |        |                                   |           |            |
| <b>Purge-and-Trap Concentrator</b>  |  | <b>EST Encon Evolution with Centurion Autosampler</b> |          |        |                                   |           |            |
| Sample Volume   | 5 mL   |   |          |        |                                   |           |            |
| Sample Temperature at Purge   | 40 °C  |   |          |        |                                   |           |            |
| Trap  | VOCARB 3000  |   |          |        |                                   |           |            |
| Purge Flow Rate   | Helium, 40 mL/minute for 11 minutes  |   |          |        |                                   |           |            |
| Dry Purge   | Helium, 40 mL/minute for 3 minutes   |   |          |        |                                   |           |            |
| Desorb  | 250 °C for 0.5 minute  |   |          |        |                                   |           |            |
| Bake  | 260 °C for 10 minutes  |   |          |        |                                   |           |            |
| <b>Analysis Times</b>   |  |   |          |        |                                   |           |            |
| GC Run Time   | 16.2 minutes   |   |          |        |                                   |           |            |
| System Cycle Time   | 26 minutes   |   |          |        |                                   |           |            |
| Peak #  | Compound Name  | Quant Ion   | Ref. Ion | Peak # | Compound Name                     | Quant Ion | Ref. Ion   |
| 1   | Chloromethane  | 50  | 52       | 20     | Bromodichloromethane              | 83*       | 85, 47*    |
| 2   | Vinyl chloride   | 62  | 64       | 21     | 2-Chloroethylvinyl ether          | 106       | -          |
| 3   | Bromomethane   | 94  | 96       | 22     | <i>cis</i> -1,3-Dichloropropene   | 75        | 77         |
| 4   | Chloroethane   | 64  | 66       | 23     | Toluene                           | 92        | 91         |
| 5   | Trichlorofluoromethane   | 101   | 103      | 24     | <i>trans</i> -1,3-Dichloropropene | 75        | 77         |
| 6   | 1,1-Dichloroethene   | 96  | 98*      | 25     | 2-Bromo-1-chloropropane (IS)      | 77        | 79         |
| 7   | Methylene chloride   | 49*   | 84*      | 26     | 1,1,2-Trichloroethane             | 97        | 83         |
| 8   | <i>trans</i> -1,2-Dichloroethene   | 96  | 61       | 27     | Tetrachloroethene                 | 164       | 129        |
| 9   | 1,1-Dichloroethane   | 63  | 65       | 28     | Dibromochloromethane              | 127       | 208*       |
| 10  | Bromochloromethane (IS)  | 128   | 130      | 29     | Chlorobenzene                     | 112       | 114        |
| 11  | Chloroform   | 83  | 85       | 30     | Ethylbenzene                      | 106       | -          |
| 12  | Pentafluorobenzene (Surr)  | 168   | -        | 31     | Bromoform                         | 173       | 171        |
| 13  | 1,1,1-Trichloroethane  | 97  | 119*     | 32     | 1,4-Dichlorobutane (IS)           | 55        | 90         |
| 14  | Carbon tetrachloride   | 117   | 121      | 33     | 4-Bromofluorobenzene (Surr)       | 95        | 176, 174   |
| 15  | Benzene  | 78  | -        | 34     | 1,1,2,2-Tetrachloroethane         | 83*       | 166*, 168* |
| 16  | 1,2-Dichloroethane   | 62*   | 98*      | 35     | 1,3-Dichlorobenzene               | 146       | 148        |
| 17  | Fluorobenzene (Surr)   | 96  | 70       | 36     | 1,4-Dichlorobenzene               | 146       | 148        |
| 18  | Trichloroethene  | 130   | 95       | 37     | 1,2-Dichlorobenzene               | 146       | 148        |
| 19  | 1,2-Dichloropropane  | 63*   | 65*      |        |                                   |           |            |
| NOTE: Quant or Reference ions indicated with an asterisk (*) have been changed from the ions suggested in US EPA Method 624 to improve sensitivity. |  |   |          |        |                                   |           |            |

■ Results and Discussion

*BFB Tune Results*

At the beginning of the project the GCMS-QP2010 SE was tuned<sup>ii</sup> to meet the US EPA Method 624 requirements. Each day prior to running any samples, and at intervals of no longer than 12-hours during long sequences, an aliquot of the 4-bromofluorobenzene (BFB) was purged and analyzed using the method conditions shown in Table 1. The BFB spectra were evaluated using the US EPA Method 624 criteria. Since BFB was one of the Surrogate Standards added to all samples, the BFB spectrum was available for evaluation for every run. A representative example of a BFB chromatogram and spectrum are shown in Figure 2.

Table 2 lists the BFB results as compared to the method criteria from three selected analyses of BFB during one of the extended sequences. The BFB spectra met all method criteria for all samples evaluated throughout the project. The tune remained stable for over 2½ months, and the GCMS-QP2010 SE instrument did not require re-tuning at any time during the analysis period.



| Mass (m/z) | Relative Abundance Criteria | Result | Status |
|------------|-----------------------------|--------|--------|
| 50         | 15 to 40% of 95             | 16.3   | Pass   |
| 75         | 30 to 60% of 95             | 43.0   | Pass   |
| 95         | Base Peak, 100%             | 100    | Pass   |
| 96         | 5 to 9% of 95               | 5.5    | Pass   |
| 173        | < 2% of 174                 | 1.4    | Pass   |
| 174        | > 50% of 95                 | 63.4   | Pass   |
| 175        | 5 to 9% of 174              | 7.1    | Pass   |
| 176        | > 95% but < 101% of 174     | 97.2   | Pass   |
| 177        | 5 to 9% of 176              | 6.3    | Pass   |

Figure 2: Typical Results from BFB Tune Evaluation Using US EPA Method 624 Criteria

**Table 2:** Evaluation of BFB Spectra from 3 Different Runs across a Long Sequence, Compared to US EPA Method 624 Criteria

| m/z | Spectrum Check Criteria            | Result |        | Result  |        | Result  |        |
|-----|------------------------------------|--------|--------|---------|--------|---------|--------|
|     |                                    | Run #1 | Status | Run #10 | Status | Run #30 | Status |
| 50  | 15 to 40% of mass 95               | 16.0   | Pass   | 15.6    | Pass   | 15.4    | Pass   |
| 75  | 30 to 60% of mass 95               | 41.2   | Pass   | 41.5    | Pass   | 43.5    | Pass   |
| 95  | Base Peak, 100% Relative Abundance | 100.0  | Pass   | 100.0   | Pass   | 100.0   | Pass   |
| 96  | 5 to 9% of mass 95                 | 6.5    | Pass   | 6.9     | Pass   | 7.0     | Pass   |
| 173 | < 2% of mass 174                   | 1.0    | Pass   | 1.6     | Pass   | 1.5     | Pass   |
| 174 | > 50% of mass 95                   | 60.8   | Pass   | 59.3    | Pass   | 61.6    | Pass   |
| 175 | 5 to 9% of mass 174                | 7.5    | Pass   | 7.4     | Pass   | 7.4     | Pass   |
| 176 | > 95% but < 101% of mass 174       | 97.2   | Pass   | 100.6   | Pass   | 97.0    | Pass   |
| 177 | 5 to 9% of mass 176                | 6.6    | Pass   | 5.6     | Pass   | 6.4     | Pass   |

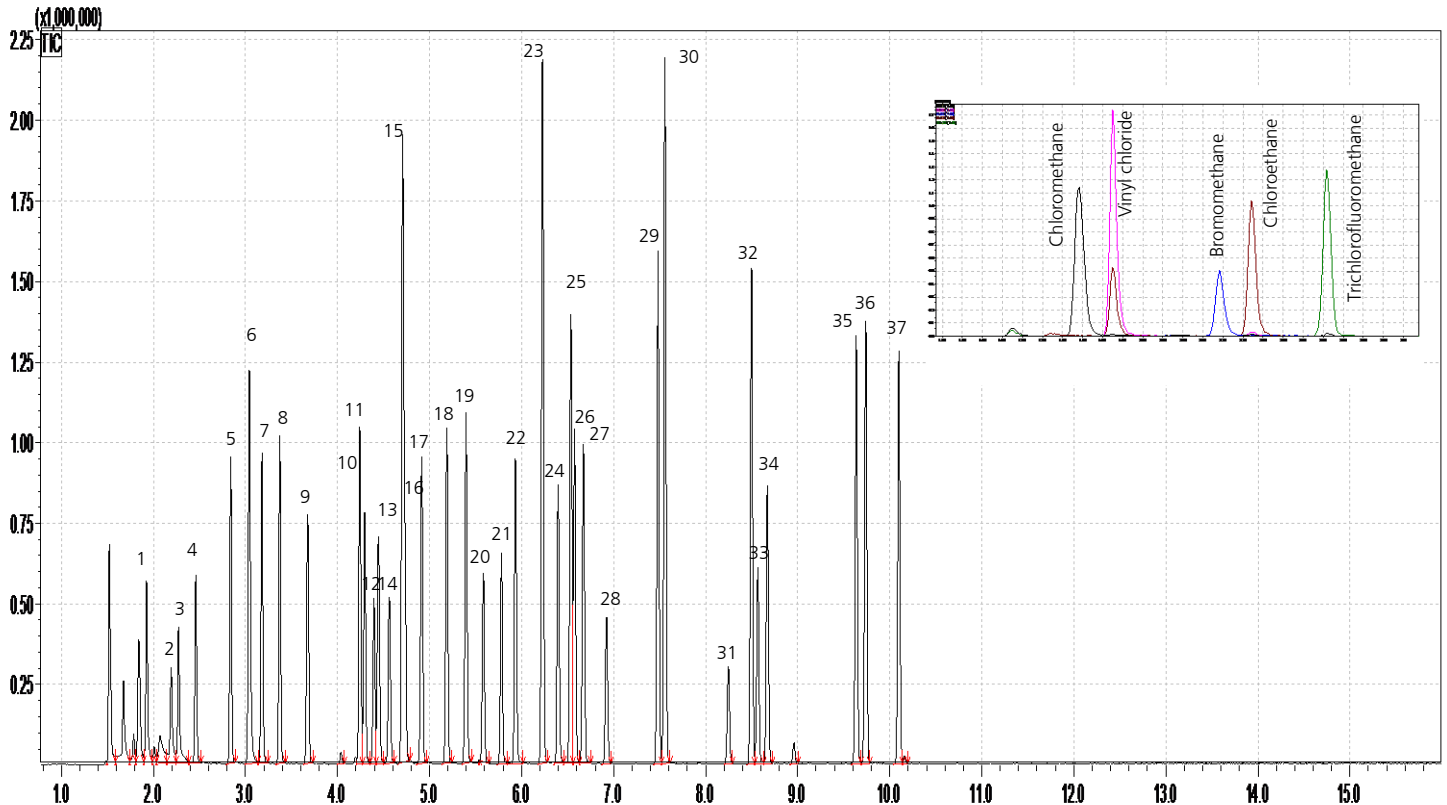
*Initial Calibration and Continuing Calibration Verification*

A series of nine initial calibration standards across the range of 0.5 to 200 µg/L (parts-per-billion, ppb) was prepared. The three internal standards (IS) were held constant at 30 µg/L, and the three surrogate standards (Surr) were held constant at 10 µg/L in all samples analyzed. A total ion chromatogram (TIC) from the 10 µg/L standard is shown in Figure 3, along with an expanded view of the chromatography of the early-eluting light gases.

The calibration curve was evaluated two ways: using correlation coefficient (R<sup>2</sup>) from a linear regression, and using the percent relative standard deviation (% RSD) of the calculated response factors (RF) for each data point in the curve. The calibration curve was

evaluated across three different concentration ranges (0.5 to 40 µg/L, 0.5 to 100 µg/L, and 0.5 to 200 µg/L) to accommodate any type of VOC project, and passed the US EPA Method 624 criteria (RF % RSD < 35%) for all compounds in all ranges.

Continuing calibration verification (CCV) standards (10 µg/L) were analyzed periodically throughout the project, as specified in US EPA Method 624. The CCV concentrations were calculated based on one of the calibration curves, and recoveries were typical for most US EPA VOC methods (80 to 120%). Complete statistical results for the initial calibration curve and three representative CCVs analyzed during the project are shown in Table 3.



**Figure 3:** Total Ion Chromatogram from the 10 µg/L Calibration Standard and EICP of the Five Light Gases. Peak numbers correspond to compound names shown in Tables 3, 4, 5, and 6.

**Table 3:** Statistical Results from the Initial Calibration and Three Representative CCVs

| Peak # | Compound Name                     | 7-Point Calibration |        |          | 8-Point Calibration |        |          | 9-Point Calibration |        |          | CCV #1                   | CCV #2 | CCV #3 |
|--------|-----------------------------------|---------------------|--------|----------|---------------------|--------|----------|---------------------|--------|----------|--------------------------|--------|--------|
|        |                                   | 0.5 to 40 µg/L      |        |          | 0.5 to 100 µg/L     |        |          | 0.5 to 200 µg/L     |        |          | Calculated Concentration |        |        |
|        |                                   | R <sup>2</sup>      | Avg RF | RF % RSD | R <sup>2</sup>      | Avg RF | RF % RSD | R <sup>2</sup>      | Avg RF | RF % RSD | µg/L                     | µg/L   | µg/L   |
| 1      | Chloromethane                     | 0.9998              | 3.01   | 10.2     | 0.9990              | 3.03   | 9.6      | 0.9995              | 3.03   | 9.0      | 8.0                      | 8.1    | 8.2    |
| 2      | Vinyl chloride                    | 0.9998              | 3.22   | 8.9      | 0.9995              | 3.23   | 8.3      | 0.9998              | 3.23   | 7.7      | 8.4                      | 8.4    | 8.5    |
| 3      | Bromomethane                      | 0.9996              | 1.24   | 10.9     | 0.9994              | 1.25   | 10.2     | 0.9998              | 1.25   | 9.6      | 8.3                      | 8.1    | 8.3    |
| 4      | Chloroethane                      | 1.0000              | 2.18   | 9.7      | 0.9998              | 2.18   | 9.0      | 0.9999              | 2.16   | 8.6      | 8.7                      | 8.7    | 8.6    |
| 5      | Trichlorofluoromethane            | 1.0000              | 2.65   | 8.9      | 0.9999              | 2.63   | 8.4      | 0.9998              | 2.64   | 7.9      | 8.7                      | 8.8    | 8.7    |
| 6      | 1,1-Dichloroethene                | 0.9999              | 2.09   | 6.9      | 0.9999              | 2.10   | 6.5      | 1.0000              | 2.11   | 6.1      | 9.1                      | 9.1    | 9.2    |
| 7      | Methylene chloride                | 1.0000              | 3.38   | 6.5      | 1.0000              | 3.37   | 6.1      | 1.0000              | 3.36   | 5.8      | 9.2                      | 9.2    | 9.1    |
| 8      | <i>trans</i> -1,2-Dichloroethene  | 1.0000              | 2.34   | 7.7      | 0.9998              | 2.34   | 7.2      | 0.9999              | 2.35   | 6.8      | 9.0                      | 9.0    | 9.0    |
| 9      | 1,1-Dichloroethane                | 1.0000              | 4.40   | 4.6      | 0.9999              | 4.41   | 4.3      | 1.0000              | 4.43   | 4.2      | 9.3                      | 9.3    | 9.4    |
| 11     | Chloroform                        | 1.0000              | 3.47   | 5.1      | 1.0000              | 3.46   | 4.7      | 1.0000              | 3.45   | 4.5      | 9.3                      | 9.3    | 9.3    |
| 12     | Pentafluorobenzene (Surr)         | NA                  | 3.83   | 2.3      | NA                  | 3.82   | 2.2      | NA                  | 3.85   | 3.2      | 9.7                      | 9.6    | 9.7    |
| 13     | 1,1,1-Trichloroethane             | 0.9999              | 2.55   | 3.2      | 1.0000              | 2.56   | 3.2      | 0.9999              | 2.56   | 3.0      | 9.4                      | 9.4    | 9.3    |
| 14     | Carbon tetrachloride              | 0.9999              | 1.77   | 7.5      | 0.9999              | 1.80   | 8.1      | 0.9991              | 1.80   | 7.6      | 9.2                      | 9.2    | 9.3    |
| 15     | Benzene                           | 1.0000              | 10.27  | 4.4      | 1.0000              | 10.28  | 4.1      | 0.9993              | 10.20  | 4.5      | 9.3                      | 9.3    | 9.3    |
| 16     | 1,2-Dichloroethane                | 1.0000              | 2.86   | 7.3      | 1.0000              | 2.85   | 7.0      | 1.0000              | 2.83   | 6.8      | 9.2                      | 9.3    | 9.2    |
| 17     | Fluorobenzene (Surr)              | NA                  | 10.47  | 1.4      | NA                  | 10.47  | 1.3      | NA                  | 10.54  | 2.4      | 9.8                      | 9.8    | 9.8    |
| 18     | Trichloroethene                   | 0.9999              | 2.23   | 3.2      | 1.0000              | 2.23   | 2.9      | 1.0000              | 2.24   | 2.8      | 10.4                     | 10.4   | 10.4   |
| 19     | 1,2-Dichloropropane               | 1.0000              | 0.73   | 4.1      | 0.9999              | 0.73   | 3.8      | 0.9997              | 0.74   | 3.9      | 9.5                      | 9.4    | 9.5    |
| 20     | Bromodichloromethane              | 0.9999              | 0.69   | 2.7      | 0.9999              | 0.69   | 3.0      | 0.9997              | 0.70   | 4.2      | 9.4                      | 9.3    | 9.4    |
| 21     | 2-Chloroethylvinyl ether          | 0.9996              | 0.13   | 11.2     | 0.9994              | 0.13   | 11.2     | 0.9999              | 0.13   | 10.9     | 9.7                      | 9.6    | 9.8    |
| 22     | <i>cis</i> -1,3-Dichloropropene   | 0.9995              | 0.88   | 6.1      | 0.9996              | 0.90   | 7.7      | 0.9999              | 0.92   | 8.7      | 9.0                      | 8.9    | 9.2    |
| 23     | Toluene                           | 0.9998              | 1.76   | 7.8      | 1.0000              | 1.76   | 7.2      | 0.9996              | 1.76   | 6.9      | 9.7                      | 9.7    | 9.7    |
| 24     | <i>trans</i> -1,3-Dichloropropene | 0.9991              | 0.76   | 8.5      | 0.9995              | 0.78   | 10.1     | 0.9998              | 0.80   | 11.1     | 8.8                      | 8.6    | 9.0    |
| 26     | 1,1,2-Trichloroethane             | 0.9999              | 0.64   | 7.1      | 1.0000              | 0.64   | 6.9      | 0.9999              | 0.63   | 6.4      | 9.3                      | 9.4    | 9.3    |
| 27     | Tetrachloroethene                 | 0.9999              | 0.45   | 6.2      | 0.9999              | 0.44   | 6.4      | 0.9976              | 0.43   | 8.8      | 9.3                      | 9.5    | 9.2    |
| 28     | Dibromochloromethane              | 0.9998              | 0.35   | 5.8      | 0.9999              | 0.35   | 6.0      | 0.9997              | 0.36   | 6.7      | 9.4                      | 9.3    | 9.5    |
| 29     | Chlorobenzene                     | 0.9999              | 1.38   | 2.4      | 1.0000              | 1.38   | 2.3      | 0.9996              | 1.38   | 2.5      | 9.7                      | 9.7    | 9.7    |
| 30     | Ethylbenzene                      | 0.9999              | 0.80   | 8.4      | 0.9999              | 0.81   | 8.0      | 0.9978              | 0.80   | 8.0      | 10.3                     | 10.4   | 10.4   |
| 31     | Bromoform                         | 0.9993              | 0.22   | 8.4      | 0.9996              | 0.23   | 9.4      | 0.9997              | 0.23   | 10.4     | 9.7                      | 9.5    | 9.9    |
| 33     | 4-Bromofluorobenzene (Surr)       | NA                  | 0.81   | 1.7      | NA                  | 0.81   | 2.3      | NA                  | 0.81   | 2.2      | 10.2                     | 10.2   | 10.2   |
| 34     | 1,1,2,2-Tetrachloroethane         | 1.0000              | 0.81   | 3.1      | 1.0000              | 0.80   | 3.4      | 1.0000              | 0.80   | 3.6      | 8.3                      | 8.3    | 8.2    |
| 35     | 1,3-Dichlorobenzene               | 0.9998              | 0.94   | 3.4      | 0.9997              | 0.94   | 3.2      | 0.9979              | 0.93   | 5.2      | 10.0                     | 10.1   | 9.9    |
| 36     | 1,4-Dichlorobenzene               | 1.0000              | 0.93   | 4.2      | 1.0000              | 0.94   | 4.0      | 0.9975              | 0.92   | 5.4      | 10.2                     | 10.3   | 10.2   |
| 37     | 1,2-Dichlorobenzene               | 1.0000              | 0.88   | 4.3      | 0.9998              | 0.88   | 3.9      | 0.9979              | 0.87   | 5.4      | 10.3                     | 10.4   | 10.3   |



*Method Detection Limit Study*

A Method Detection Limit (MDL) study was conducted by analyzing 8 replicate aliquots each of the 0.5 and 1.0 µg/L standards. The MDLs were calculated using the procedure outlined in the Federal Register<sup>iii</sup>, and all MDLs easily met the

criteria, and exceeded the MDLs cited in the US EPA Method 624 by approximately a factor of 10 or more. Table 4 lists the details of the MDL study results.

**Table 4:** Method Detection Limit (MDL) Study Results

| Peak # | Compound Name               | 0.5 µg/L<br>n = 8 |      | 1.0 µg/L<br>n = 8 |      |
|--------|-----------------------------|-------------------|------|-------------------|------|
|        |                             | % RSD             | MDL  | % RSD             | MDL  |
| 1      | Chloromethane               | 8.6               | 0.14 | 4.3               | 0.12 |
| 2      | Vinyl chloride              | 5.5               | 0.08 | 3.7               | 0.11 |
| 3      | Bromomethane                | 11.5              | 0.21 | 15.0              | 0.51 |
| 4      | Chloroethane                | 4.8               | 0.08 | 5.1               | 0.15 |
| 5      | Trichlorofluoromethane      | 8.2               | 0.14 | 1.9               | 0.06 |
| 6      | 1,1-Dichloroethene          | 5.4               | 0.08 | 7.4               | 0.22 |
| 7      | Methylene chloride          | 6.2               | 0.10 | 8.8               | 0.29 |
| 8      | trans-1,2-Dichloroethene    | 8.0               | 0.12 | 9.5               | 0.30 |
| 9      | 1,1-Dichloroethane          | 4.8               | 0.07 | 5.2               | 0.15 |
| 11     | Chloroform                  | 4.6               | 0.07 | 5.7               | 0.18 |
| 12     | Pentafluorobenzene (Surr)   | 1.1               | 0.34 | 1.8               | 0.51 |
| 13     | 1,1,1-Trichloroethane       | 8.1               | 0.11 | 5.8               | 0.16 |
| 14     | Carbon tetrachloride        | 4.6               | 0.06 | 9.1               | 0.25 |
| 15     | Benzene                     | 2.8               | 0.04 | 5.1               | 0.15 |
| 16     | 1,2-Dichloroethane          | 3.8               | 0.06 | 6.9               | 0.22 |
| 17     | Fluorobenzene (Surr)        | 1.4               | 0.40 | 1.2               | 0.37 |
| 18     | Trichloroethene             | 3.3               | 0.05 | 8.6               | 0.26 |
| 19     | 1,2-Dichloropropane         | 3.1               | 0.05 | 3.6               | 0.11 |
| 20     | Bromodichloromethane        | 7.1               | 0.10 | 7.3               | 0.22 |
| 21     | 2-Chloroethylvinyl ether    | 12.4              | 0.17 | 5.3               | 0.14 |
| 22     | cis-1,3_Dichloropropene     | 4.8               | 0.07 | 9.7               | 0.27 |
| 23     | Toluene                     | 5.7               | 0.08 | 4.7               | 0.13 |
| 24     | trans-1,3-Dichloropropene   | 7.6               | 0.10 | 9.2               | 0.27 |
| 26     | 1,1,2-Trichloroethane       | 3.6               | 0.06 | 3.0               | 0.09 |
| 27     | Tetrachloroethene           | 4.6               | 0.07 | 8.0               | 0.24 |
| 28     | Dibromochloromethane        | 5.4               | 0.08 | 5.4               | 0.17 |
| 29     | Chlorobenzene               | 4.7               | 0.07 | 5.2               | 0.16 |
| 30     | Ethylbenzene                | 3.6               | 0.04 | 8.2               | 0.21 |
| 31     | Bromoform                   | 7.5               | 0.10 | 4.2               | 0.12 |
| 33     | 4-Bromofluorobenzene (Surr) | 0.7               | 0.21 | 1.3               | 0.39 |
| 34     | 1,1,2,2-Tetrachloroethane   | 5.4               | 0.08 | 3.9               | 0.12 |
| 35     | 1,3-Dichlorobenzene         | 4.8               | 0.07 | 8.5               | 0.26 |
| 36     | 1,4-Dichlorobenzene         | 5.1               | 0.08 | 8.5               | 0.26 |
| 37     | 1,2-Dichlorobenzene         | 5.6               | 0.08 | 8.7               | 0.26 |

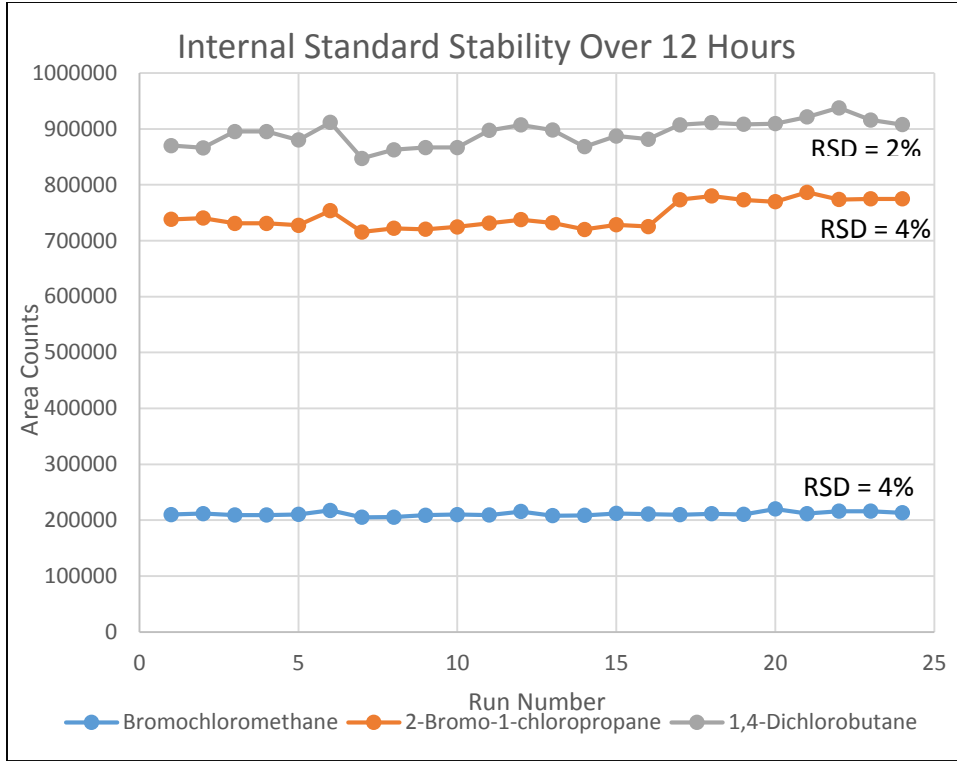
*Precision and Accuracy Study*

A Precision and Accuracy (P&A) study was conducted to gauge the expected performance of the method at different concentration levels. Eight replicate aliquots each of the 0.5, 1.0, and 20 µg/L standards were analyzed using the operating conditions shown above. Table 5 lists the detailed results of the P&A study, reporting the average concentration reported for each compound (n = 8), the percent recovery, and the %RSD for all compounds at all three levels.

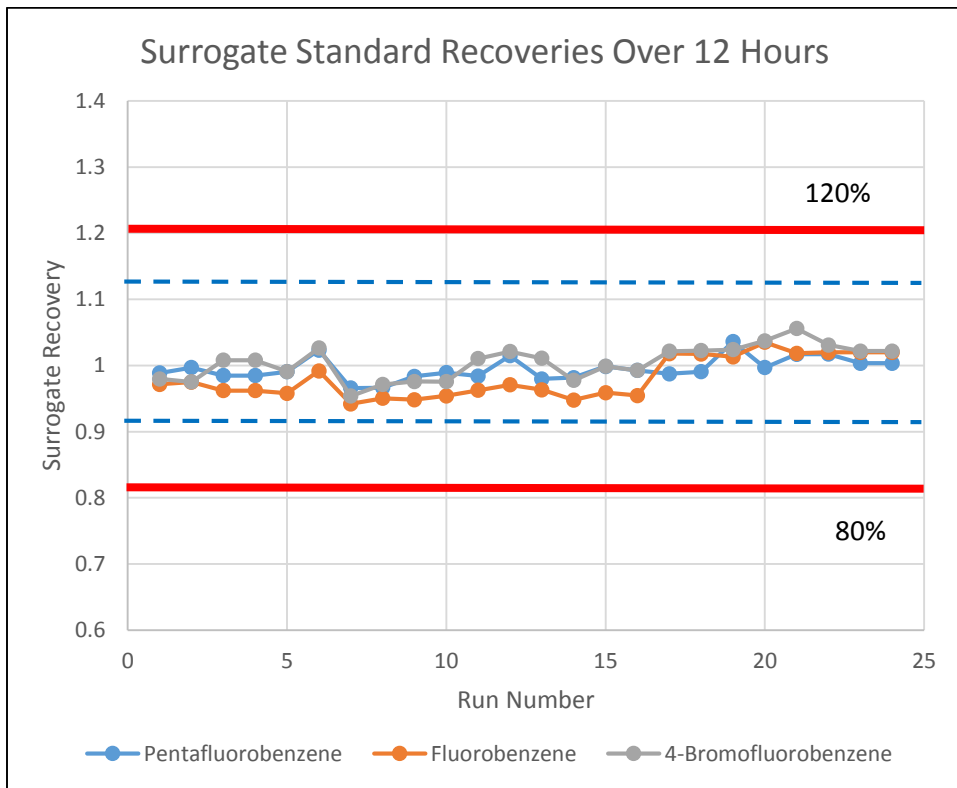
Internal standard response remained stable during the entire study at ≤ 4%, and Surrogate recoveries fell within the 80 – 120 % method criteria for all analyses. IS and Surr results from a representative 12-hour sequence are shown in Figures 4 and 5, respectively.

**Table 5:** Precision and Accuracy (P&A) Study Results

| Peak # | Compound Name                     | Precision and Accuracy at 0.5 µg/L<br>n = 8 |          |      | Precision and Accuracy at 1.0 µg/L<br>n = 8 |          |      | Precision and Accuracy at 20 µg/L<br>n = 8 |          |      |
|--------|-----------------------------------|---|----------|------|---|----------|------|--|----------|------|
|        |                                   | Mean Concentration (µg/L)                   | Recovery | %RSD | Mean Concentration (µg/L)                   | Recovery | %RSD | Mean Concentration (µg/L)                  | Recovery | %RSD |
| 1      | Chloromethane                     | 0.55  | 110%     | 8.6  | 0.98  | 98%      | 4.3  | 16.35                                      | 82%      | 2.8  |
| 2      | Vinyl chloride                    | 0.52  | 103%     | 5.5  | 0.95  | 95%      | 3.7  | 16.83                                      | 84%      | 5.0  |
| 3      | Bromomethane                      | 0.61  | 122%     | 11.5 | 1.15  | 115%     | 15.0 | 16.55                                      | 83%      | 3.5  |
| 4      | Chloroethane                      | 0.53  | 106%     | 4.8  | 1.00  | 100%     | 5.1  | 17.14                                      | 86%      | 3.7  |
| 5      | Trichlorofluoromethane            | 0.56  | 112%     | 8.2  | 0.99  | 99%      | 1.9  | 17.19                                      | 86%      | 4.9  |
| 6      | 1,1-Dichloroethene                | 0.51  | 102%     | 5.4  | 0.98  | 98%      | 7.4  | 18.07                                      | 90%      | 4.8  |
| 7      | Methylene chloride                | 0.55  | 110%     | 6.2  | 1.09  | 109%     | 8.8  | 18.25                                      | 91%      | 3.0  |
| 8      | <i>trans</i> -1,2-Dichloroethene  | 0.52  | 104%     | 8.0  | 1.05  | 105%     | 9.5  | 18.12                                      | 91%      | 4.2  |
| 9      | 1,1-Dichloroethane                | 0.50  | 100%     | 4.8  | 0.98  | 98%      | 5.2  | 18.66                                      | 93%      | 3.5  |
| 10     | Bromochloromethane (IS)           | 30.00                                       | NA       | NA   | 30.00                                       | NA       | NA   | 30.00                                      | NA       | NA   |
| 11     | Chloroform                        | 0.52  | 104%     | 4.6  | 1.04  | 104%     | 5.7  | 18.59                                      | 93%      | 3.3  |
| 12     | Pentafluorobenzene (Surr)         | 9.86  | 99%      | 1.1  | 9.67  | 97%      | 1.8  | 9.91                                       | 99%      | 2.4  |
| 13     | 1,1,1-Trichloroethane             | 0.46  | 91%      | 8.1  | 0.95  | 95%      | 5.8  | 18.69                                      | 93%      | 3.8  |
| 14     | Carbon tetrachloride              | 0.41  | 81%      | 4.6  | 0.91  | 91%      | 9.1  | 19.31                                      | 97%      | 3.8  |
| 15     | Benzene                           | 0.50  | 99%      | 2.8  | 0.98  | 98%      | 5.1  | 18.67                                      | 93%      | 3.6  |
| 16     | 1,2-Dichloroethane                | 0.52  | 105%     | 3.8  | 1.06  | 106%     | 6.9  | 18.49                                      | 92%      | 2.0  |
| 17     | Fluorobenzene (Surr)              | 9.77  | 98%      | 1.4  | 9.80  | 98%      | 1.2  | 9.93                                       | 99%      | 2.0  |
| 18     | Trichloroethene                   | 0.52  | 104%     | 3.3  | 1.02  | 102%     | 8.6  | 18.64                                      | 93%      | 4.1  |
| 19     | 1,2-Dichloropropane               | 0.53  | 105%     | 3.1  | 1.02  | 102%     | 3.6  | 18.76                                      | 94%      | 1.4  |
| 20     | Bromodichloromethane              | 0.49  | 98%      | 7.1  | 1.01  | 101%     | 7.3  | 19.20                                      | 96%      | 1.6  |
| 21     | 2-Chloroethylvinyl ether          | 0.47  | 93%      | 12.4 | 0.87  | 87%      | 5.3  | 20.40                                      | 102%     | 1.2  |
| 22     | <i>cis</i> -1,3-Dichloropropene   | 0.46  | 92%      | 4.8  | 0.95  | 95%      | 9.7  | 18.72                                      | 94%      | 1.4  |
| 23     | Toluene                           | 0.47  | 93%      | 5.7  | 0.92  | 92%      | 4.7  | 19.35                                      | 97%      | 2.1  |
| 24     | <i>trans</i> -1,3-Dichloropropene | 0.45  | 90%      | 7.6  | 0.97  | 97%      | 9.2  | 18.87                                      | 94%      | 1.0  |
| 25     | 2-Bromo-1-chloropropane (IS)      | 30.00                                       | NA       | NA   | 30.00                                       | NA       | NA   | 30.00                                      | NA       | NA   |
| 26     | 1,1,2-Trichloroethane             | 0.54  | 108%     | 3.6  | 1.06  | 106%     | 3.0  | 18.94                                      | 95%      | 1.5  |
| 27     | Tetrachloroethene                 | 0.52  | 104%     | 4.6  | 1.02  | 102%     | 8.0  | 18.08                                      | 90%      | 2.7  |
| 28     | Dibromochloromethane              | 0.49  | 98%      | 5.4  | 1.05  | 105%     | 5.4  | 19.96                                      | 100%     | 1.3  |
| 29     | Chlorobenzene                     | 0.50  | 100%     | 4.7  | 0.99  | 99%      | 5.2  | 19.63                                      | 98%      | 1.5  |
| 30     | Ethylbenzene                      | 0.41  | 83%      | 3.6  | 0.85  | 85%      | 8.2  | 20.57                                      | 103%     | 2.4  |
| 31     | Bromoform                         | 0.46  | 93%      | 7.5  | 0.97  | 97%      | 4.2  | 20.10                                      | 100%     | 1.7  |
| 32     | 1,4-Dichlorobutane (IS)           | 30.00                                       | NA       | NA   | 30.00                                       | NA       | NA   | 30.00                                      | NA       | NA   |
| 33     | 4-Bromofluorobenzene (Surr)       | 10.15                                       | 101%     | 0.7  | 10.10                                       | 101%     | 1.3  | 9.99                                       | 100%     | 1.4  |
| 34     | 1,1,2,2-Tetrachloroethane         | 0.51  | 103%     | 5.4  | 1.07  | 107%     | 3.9  | 19.31                                      | 97%      | 1.3  |
| 35     | 1,3-Dichlorobenzene               | 0.51  | 102%     | 4.8  | 1.03  | 103%     | 8.5  | 19.82                                      | 99%      | 0.5  |
| 36     | 1,4-Dichlorobenzene               | 0.51  | 101%     | 5.1  | 1.03  | 103%     | 8.5  | 20.51                                      | 103%     | 1.6  |
| 37     | 1,2-Dichlorobenzene               | 0.50  | 101%     | 5.6  | 1.01  | 101%     | 8.7  | 20.55                                      | 103%     | 1.2  |



**Figure 4:** Internal Standard Response over a Representative 12-Hour Tune Period during This Study



**Figure 5:** Surrogate Standard Recoveries over a Representative 12-Hour Tune Period during This Study

*Analysis of Reference Material and Real-world Samples*

An analytical standard from a second source was obtained and analyzed as a Reference Material. It was spiked at 100 µg/L and analyzed in triplicate. Repeatability across the three replicates yielded %RSD between 0.2 and 5.4% for all compounds, average %RSD of 1.8%, and average recovery of 109 to 111% for all compounds.

Three real-world wastewater samples were also analyzed in triplicate. Most compounds were either

not detected or were detected at concentrations below the calibration range (coded J). One compound, chlorobenzene, was detected in all three samples at concentrations ranging from 300 to 400 µg/L and had to be diluted. The EST Centurion Water/Soil Autosampler has an optional syringe that provided auto-dilution capability and produced repeatable results. Results from analysis of the Reference Material and the three real-world samples are summarized in Table 6.

**Table 6:** Summary of Results from Triplicate Analyses of One Second Source Reference Material and Three Real-World Samples

| Peak #                  | Compound Name                | 2nd Source | Sample #1    |                 |              |                 | Sample #2    |                 |              |                 | Sample #3    |                 |              |                 |
|-------------------------|------------------------------|------------|--------------|-----------------|--------------|-----------------|--------------|-----------------|--------------|-----------------|--------------|-----------------|--------------|-----------------|
|                         |                              |            | Original     |                 | 1:5 Dilution |                 | Original     |                 | 1:5 Dilution |                 | Original     |                 | 1:5 Dilution |                 |
|                         |                              |            | %RSD (n = 3) | Avg Conc (µg/L) | %RSD (n = 3) | Avg Conc (µg/L) | %RSD (n = 3) | Avg Conc (µg/L) | %RSD (n = 3) | Avg Conc (µg/L) | %RSD (n = 3) | Avg Conc (µg/L) | %RSD (n = 3) | Avg Conc (µg/L) |
| 1                       | Chloromethane                | 1.3        | J            | J               | J            | J               | J            | J               | J            | J               | J            | J               | J            | J               |
| 2                       | Vinyl chloride               | 1.0        | ND           | ND              | ND           | ND              | ND           | ND              | ND           | ND              | ND           | ND              | ND           | ND              |
| 3                       | Bromomethane                 | 5.4        | J            | J               | J            | J               | J            | J               | J            | J               | J            | J               | J            | J               |
| 4                       | Chloroethane                 | 0.2        | ND           | ND              | ND           | ND              | J            | J               | J            | J               | J            | J               | J            | J               |
| 5                       | Trichlorofluoromethane       | 1.1        | J            | J               | J            | J               | J            | J               | J            | J               | J            | J               | J            | J               |
| 6                       | 1,1-Dichloroethene           | 1.7        | ND           | ND              | ND           | ND              | ND           | ND              | ND           | ND              | ND           | ND              | ND           | ND              |
| 7                       | Methylene chloride           | 1.7        | 5.8          | 1.9             | 5.2          | 2.3             | 14.4         | 0.7             | 9.6          | 2.9             | 9.0          | 2.5             | 8.8          | 1.3             |
| 8                       | trans-1,2-dichloroethene     | 1.1        | ND           | ND              | ND           | ND              | ND           | ND              | ND           | ND              | ND           | ND              | ND           | ND              |
| 9                       | 1,1-Dichloroethane           | 0.8        | ND           | ND              | ND           | ND              | ND           | ND              | ND           | ND              | ND           | ND              | ND           | ND              |
| 10                      | Bromochloromethane (IS)      |            | 30.0         | NA              | 30.0         | NA              | 30.0         | NA              | 30.0         | NA              | 30.0         | NA              | 30.0         | NA              |
| 11                      | Chloroform                   | 0.9        | J            | J               | J            | J               | 3.0          | 3.8             | 3.8          | 7.8             | 6.1          | 4.9             | 5.9          | 2.6             |
| 12                      | Pentafluorobenzene (Surr)    | 1.4        | 10.0         | 2.5             | 13.0         | 0.8             | 9.5          | 0.7             | 13.1         | 1.8             | 9.4          | 1.8             | 13.5         | 2.4             |
| 13                      | 1,1,1-trichloroethane        | 1.2        | ND           | ND              | ND           | ND              | ND           | ND              | ND           | ND              | ND           | ND              | ND           | ND              |
| 14                      | Carbon tetrachloride         | 1.3        | ND           | ND              | ND           | ND              | ND           | ND              | ND           | ND              | ND           | ND              | ND           | ND              |
| 15                      | Benzene                      | 0.6        | 0.6          | 3.5             | 0.6          | 5.8             | 1.3          | 2.0             | 0.8          | 2.5             | 0.9          | 2.0             | 0.6          | 3.8             |
| 16                      | 1,2-Dichloroethane           | 1.1        | ND           | ND              | ND           | ND              | ND           | ND              | ND           | ND              | ND           | ND              | ND           | ND              |
| 17                      | Fluorobenzene (Surr)         | 2.9        | 9.9          | 0.8             | 11.9         | 0.6             | 10.1         | 1.4             | 11.9         | 1.5             | 10.2         | 3.3             | 12.0         | 1.0             |
| 18                      | Trichloroethene              | 0.6        | ND           | ND              | ND           | ND              | ND           | ND              | ND           | ND              | ND           | ND              | ND           | ND              |
| 19                      | 1,2-Dichloropropane          | 2.2        | ND           | ND              | ND           | ND              | ND           | ND              | ND           | ND              | ND           | ND              | ND           | ND              |
| 20                      | Bromodichloromethane         | 2.1        | J            | J               | J            | J               | J            | J               | J            | J               | 2.9          | 1.6             | 2.7          | 2.5             |
| 21                      | 2-Chloroethylvinyl ether     | ND         | ND           | ND              | ND           | ND              | ND           | ND              | ND           | ND              | ND           | ND              | ND           | ND              |
| 22                      | cis-1,3-Dichloropropene      | 2.0        | ND           | ND              | ND           | ND              | ND           | ND              | ND           | ND              | ND           | ND              | ND           | ND              |
| 23                      | Toluene                      | 2.2        | 2.3          | 1.8             | 1.5          | 20.1            | 4.6          | 2.0             | 3.2          | 1.9             | 3.2          | 6.5             | 2.2          | 4.4             |
| 24                      | trans-1,3-dichloropropene    | 2.0        | J            | J               | J            | J               | ND           | ND              | ND           | ND              | ND           | ND              | ND           | ND              |
| 25                      | 2-Bromo-1-chloropropane (IS) |            | 30.0         | NA              | 30.0         | NA              | 30.0         | NA              | 30.0         | NA              | 30.0         | NA              | 30.0         | NA              |
| 26                      | 1,1,2-Trichloroethane        | 2.0        | ND           | ND              | ND           | ND              | ND           | ND              | ND           | ND              | ND           | ND              | ND           | ND              |
| 27                      | Tetrachloroethene            | 4.4        | ND           | ND              | ND           | ND              | ND           | ND              | ND           | ND              | ND           | ND              | ND           | ND              |
| 28                      | Dibromochloromethane         | 2.6        | ND           | ND              | ND           | ND              | ND           | ND              | ND           | ND              | 1.9          | 5.0             | ND           | ND              |
| 29                      | Chlorobenzene                | 1.5        | 418.9        | 0.8             | 85.8         | 22.4            | 347.3        | 0.9             | 71.3         | 1.2             | 302.7        | 2.1             | 63.8         | 3.4             |
| 30                      | Ethylbenzene                 | 1.7        | J            | J               | J            | J               | J            | J               | J            | J               | J            | J               | J            | J               |
| 31                      | Bromoform                    | 1.7        | J            | J               | J            | J               | J            | J               | J            | J               | J            | J               | J            | J               |
| 32                      | 1,4-Dichlorobutane (IS)      |            | 30.0         | NA              | 30.0         | NA              | 30.0         | NA              | 30.0         | NA              | 30.0         | NA              | 30.0         | NA              |
| 33                      | 4-Bromofluorobenzene (Surr)  | 3.1        | 9.8          | 1.1             | 9.1          | 0.9             | 9.5          | 1.1             | 9.3          | 0.9             | 9.8          | 2.1             | 9.5          | 1.8             |
| 34                      | 1,1,2,2-Tetrachloroethane    | 1.2        | ND           | ND              | ND           | ND              | ND           | ND              | ND           | ND              | ND           | ND              | ND           | ND              |
| 35                      | 1,3-Dichlorobenzene          | 3.1        | J            | J               | J            | J               | J            | J               | J            | J               | J            | J               | J            | J               |
| 36                      | 1,4-Dichlorobenzene          | 2.9        | J            | J               | J            | J               | J            | J               | J            | J               | J            | J               | J            | J               |
| 37                      | 1,2-Dichlorobenzene          | 1.9        | ND           | ND              | ND           | ND              | ND           | ND              | ND           | ND              | ND           | ND              | ND           | ND              |
| <b>Average %RSD</b>     |                              | 1.8%       |              |                 |              |                 |              |                 |              |                 |              |                 |              |                 |
| <b>Average Recovery</b> |                              | 109-111%   |              |                 |              |                 |              |                 |              |                 |              |                 |              |                 |

### ■ Summary and Conclusions

The instrumentation and analytical conditions shown here have been demonstrated to provide outstanding results for US EPA Method 624, far exceeding all existing method criteria. The narrow-bore capillary column and Constant Linear Velocity mode provided outstanding chromatography for all compounds, including the early-eluting light gases, in less than 10 minutes. Calibration curves over narrow or wide ranges can be used to meet the project or contract needs. MDLs are easily 10-fold lower than the MDLs cited in the method, and a high level of precision and accuracy can be expected across any calibration range, particularly at the lower concentrations.

### ■ Ordering Information for Replacement Consumables

The consumables used in this application note are shown in the table below. To order any of these items please contact Customer Service at Shimadzu Scientific Instruments at 1-800-477-1227, or visit our web store at <http://store.shimadzu.com>.

| Part Number  | Item Name                                      | Photo   | Item Description  |
|--------------|--|---|---|
| 221-75962-30 | Capillary Column                               |    | SH-RXI-624 SIL MS, 30 m x 0.25 mm x 1.40 µm   |
| 220-90784-10 | Inlet Liner                                    |    | Low-volume Liner, 1.0 mm ID, Straight, 5/Pkg (Restek)   |
| 220-94775-10 | VOA Tuning Compound                            |    | 1-Bromo-4-fluorobenzene (BFB), 5,000 µg/mL in P&T MeOH, 1 mL/ampule, CAS #: 460-00-4 (Restek) |
| 220-94775-11 | 624 Internal Standard Mix (3 Components)       |  | 1,500 µg/mL each in P&T MeOH, 1 mL/ampule (Restek)  |
| 220-94775-12 | 624 Surrogate Standard Mix (3 Components)      |  | 2,000 µg/mL each in P&T MeOH, 1 mL/ampule (Restek)  |
| 220-94775-13 | 624 Volatiles Standard Mix (26 Components)     |  | 2,000 µg/mL each in P&T MeOH, 1 mL/ampule (Restek)  |
| 220-94775-14 | 502.2 Calibration Mix #1, Gases (6 Components) |  | 2,000 µg/mL each in P&T MeOH, 1 mL/ampule (Restek)  |
| 220-94775-00 | n-Alkane Mix                                   |  | AART Standard for determination of Retention Index (RI) and Retention Times (RT)              |
| 220-94594-00 | Electronic Flow Meter                          |  | ProFLOW 6000 Electronic Flow Meter (Restek)   |
| 220-94594-01 | Electronic Leak Detector                       |  | Electronic Leak Detector With Hard-Sided Carrying Case and Universal Charger Set (Restek)     |

■ **References**

- I. Appendix A to Part 136, Methods for Organic Chemical Analysis of Municipal and Industrial Wastewater, Method 624 – Purgeables.
- II. Shimadzu Guide to BFB Tuning for Analysis of Volatile Organic Compounds, GCMS Application News No. GCMS-1405.
- III. Definition and Procedure for the Determination of the Method Detection Limit. *Fed. Regist.* **1984**. 49 (209), Appendix B to Part 136.

---

First Edition: November 2014



**SHIMADZU Corporation**  
[www.shimadzu.com/an/](http://www.shimadzu.com/an/)

**SHIMADZU SCIENTIFIC INSTRUMENTS**  
7102 Riverwood Drive, Columbia, MD 21046, USA  
Phone: 800-477-1227/410-381-1227, Fax: 410-381-1222  
URL: [www.ssi.shimadzu.com](http://www.ssi.shimadzu.com)

For Research Use Only. Not for use in diagnostic procedures.  
The contents of this publication are provided to you "as is" without warranty of any kind, and are subject to change without notice.  
Shimadzu does not assume any responsibility or liability for any damage, whether direct or indirect, relating to the use of this publication.

# Application News

## No. A512

### Spectrophotometric Analysis

## Measurement of Hexavalent Chromium in Chromate Conversion Coating and Metal Ions in Eluate – Application of Water Analysis Program for the UV-1280 –

In the electrical and electronics sector, not only does a standard apply for industrial wastewater resulting from the manufacture of electrical and electronic equipment (JIS K 0102 Testing methods for industrial wastewater), manufacturers must also abide by restrictions on the use of specific toxic substances (RoHS Directive). These standards and restrictions brought about a change in the treatment agent used for chromate conversion coating used to improve corrosion resistance from hexavalent chromium to trivalent chromium, a change in the solder used to join metals to a lead-free type. The presence of these constituents and the amounts of these constituents present in waste liquids must also be managed.

The water analysis program for the UV-1280 UV-VIS spectrophotometer can be used with a PACKTEST series of products made by Kyoritsu Chemical-Check Lab., Corp. to easily test for 39 water quality items and 22 water quality species, including hexavalent chromium and lead.

This Application News describes the measurements of the amount of hexavalent chromium used in plating on screws, and the amounts of metal ions that elute from commercially available lead and copper products, using the water analysis program for the UV-1280.

### ■ Measurement of Hexavalent Chromium in Chromate Conversion Coating

The UV-1280 and a PACKTEST product from Kyoritsu Chemical-Check Lab., Corp. are shown in Fig. 1. The water analysis program displays analytical procedures on-screen, so the concentration of target constituents can be measured by simply following the on-screen instructions. An example on-screen view is shown in Fig. 2. A trend graphing function can also be used to observe daily changes in concentration levels. See Application News No. A503 for more information about trend graphing. The hot water extraction procedure described in IEC 62321 was performed on commercially available screws with different chromate conversion treatments, and measurements were taken using the PACKTEST Chromium (Hexavalent) product. Fig. 3 shows the screws analyzed, and Table 1 shows the analytical conditions used.

The surface area (cm<sup>2</sup>) of the screws was calculated using the formulas shown in IEC 62321, and the amounts of pure water used for extraction were prepared with 1 mL for every 1 cm<sup>2</sup> of surface area<sup>1)</sup>. Three of the colored chromate screws, and 4 of the glossy chromate screws and black chromate screws were used for a total surface area of at least 25 cm<sup>2</sup>. The extraction solvent was boiled and test samples were inserted into the solvent. Test samples were removed after heating for 10 minutes, the extraction

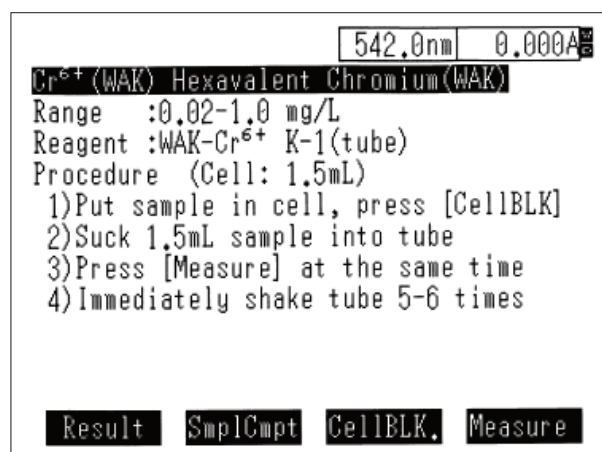
solvent was allowed to return to room temperature, a given volume was made up with dilution as required, and measurements were performed. Results of these measurements are shown in Table 2.

**Table 1 Analytical Conditions**

|               |   |
|---------------|---|
| Instrument    | : UV-1280<br>Water analysis program<br>PACKTEST Chromium (Hexavalent) |
| Item Measured | : Hexavalent chromium (PACKTEST)                                      |



**Fig. 1 UV-1280 and PACKTEST Product**



**Fig. 2 Measurement Procedure for Hexavalent Chromium (PACKTEST)**



**Fig. 3 Chromate-Coated Screws**

**Table 2 Concentrations of Extracted Hexavalent Chromium and Formula for Calculating Hexavalent Chromium Concentration**

|          | Colored Chromate Screw Surface Area: 19.6 cm <sup>2</sup> |  | Glossy Chromate Screw Surface Area: 12.1 cm <sup>2</sup> |   | Black Chromate Screw Surface Area: 12.2 cm <sup>2</sup> |  |
|----------|---|--|--|---|---|--|
|          | Extraction Liquid (mg/L) *1                               | Extracted Amount (µg/cm <sup>2</sup> ) | Extraction Liquid (mg/L)                                 | Extracted Amount (µg/cm <sup>2</sup> ) *3 | Extraction Liquid (mg/L) *2                             | Extracted Amount (µg/cm <sup>2</sup> ) |
| 1st time | 0.37  | 3.73                                   | < 0.02   | -   | 0.49  | 0.97                                   |
| 2nd time | 0.26  | 2.55                                   | < 0.02   | -   | 0.72  | 1.44                                   |
| 3rd time | 0.48  | 4.79                                   | < 0.02   | -   | 1.03  | 2.06                                   |

\*1: Measurement performed after diluting extraction liquid 10-fold  
 \*2: Measurement performed after diluting extraction liquid 2-fold  
 All values in table are measurement results after dilution.  
 \*3: Not calculated. Extraction liquid concentration below lower limit of detection

$$Cr(VI) = \frac{C \times V}{S} \times DF$$

Cr (VI): Amount of hexavalent chromium (µg/cm<sup>2</sup>) in chromate conversion coating  
 C: Concentration (mg/L), V: Extraction solvent (mL)  
 S: Surface area (cm<sup>2</sup>), DF: Dilution ratio

Hexavalent chromium was detected on the colored chromate screws and black chromate screws, but was not detected on the glossy chromate screws. The liquid used for extraction from the colored chromate screws was diluted 10-fold before measurement, and the liquid used for extraction from the black chromate screws was diluted 2-fold before measurement. The variance in results obtained from the 3 repeated measurements shown in Table 2 is presumed to be caused by differences between individual sample screws, as well as differences in extraction times, amounts of extraction solvent, and temperature<sup>2)</sup>.

### ■ Measurement of Metal Ions Eluted from Products

Lead is used as an ingredient in fishing weights and solder due to its low melting point, good workability, and high specific gravity. Copper is used in electrical wires and cooking utensils due to its good electrical conductivity and thermal conductivity. Copper is also known to have antimicrobial properties<sup>3)</sup>.

Three lead weights (approximately 22.5 g) were immersed in 50 mL of pure water (room temperature), and amounts of lead ions eluted were measured at different elution times. A 10 yen coin, copper wire, and copper sheet were immersed in 50 mL of pure water for 1 day (room temperature), and the trace amounts of copper ions eluted were measured. Fig. 4 shows the samples used, Table 3 shows the analytical conditions, and Table 4 and 5 show the results obtained.

**Table 3 Analytical Conditions**

|               |  |
|---------------|--|
| Instrument    | : UV-1280<br>Water analysis program<br>PACKTEST Lead set, Copper |
| Item Measured | : Lead and Copper  |



**Fig. 4 Lead Samples and Copper Samples**

**Table 4 Relationship Between Concentration of Eluted Lead Ions and Elution Time**

|       | Elution Time |             |             |
|-------|--------------|-------------|-------------|
|       | 1 minute     | 2 minutes*4 | 5 minutes*5 |
| No. 1 | 0.31 mg/L    | 0.66 mg/L   | 1.68 mg/L   |
| No. 2 | 0.41 mg/L    | 0.74 mg/L   | 2.15 mg/L   |
| No. 3 | 0.32 mg/L    | 0.85 mg/L   | 3.76 mg/L   |

\*4: Measurement performed after diluting elution liquid 2-fold  
 \*5: Measurement performed after diluting elution liquid 10-fold  
 All values in table have been converted to elution liquid concentrations.

**Table 5 Concentration of Eluted Copper Ions**

| Sample       | Weight | Eluted Concentration |
|--------------|--------|----------------------|
| Copper wire  | 2.85 g | < 0.1 mg/L           |
| Copper sheet | 1.18 g | 0.33 mg/L            |
| 10 yen coin  | 4.43 g | 0.33 mg/L            |

The amount of lead ion eluted from the lead weights increased with elution time. Results also show the amount eluted varied depending on sample shape. We detected trace amounts of copper ion eluted from the copper sheet and 10 yen coin, but could not detect copper ions eluted from the copper wire. Copper wire is given an enamel coating treatment for insulation, which is presumed to be the reason that no copper ions were detected in the elution liquid.

### ■ Conclusions

The water analysis program for the UV-1280 and PACKTEST series of products from Kyoritsu Chemical-Check Lab., Corp. can be used to manage the amount of hexavalent chromium in chromate conversion coating, the amount of metal ions eluted from products, and the amounts of metal ions in plating solutions and waste liquids.

#### References

- 1) IEC 62321-7-1/Ed.1: Presence of hexavalent chromium (Cr (VI)) in colourless and coloured corrosion-protected coatings on metals by the colourimetric method
- 2) Naori Sasaki, Ryoji Nakazawa, Mami Tanaka, Tadashi Doi, Kaori Urasaki: Improved Repeatability of Hexavalent Chromium measurements in Chromate Conversion Coating, Bulletin of Tokyo Metropolitan Industrial Technology Research Institute No. 7 (2012)
- 3) Japan Copper Development Association web site <http://www.jcda.or.jp/>



## Application News

# No. A551

### Spectrophotometric Analysis

## Analysis of Minor Components in Water Using the IRSpirit

Water absorbs strongly in the mid-infrared region, which makes it difficult to detect and identify solutes in low concentration aqueous solutions. The water bands simply overwhelm spectral contributions of minor components. Several processing and sampling techniques have been developed to get around this issue. For meaningful results however, these methods require both stability and sensitivity of the FTIR instrument.

This article describes a difference spectrum method and sample condensation technique using the compact IRSpirit, a stable and sensitive compact FTIR instrument.

S. Iwasaki

### ■ Aqueous Solution Analysis via FT-ATR

Pollution load monitoring is utilized increasingly in industry, and not only to prevent the release of regulated pollutants (downstream monitoring). Water used in manufacturing processes can impact the quality of finished products, so upstream monitoring to characterize water quality (as a process parameter) is also important. Online TOC (Total Organic Carbon) is commonly employed for water monitoring, providing rapid quantification of organic carbon. It cannot however, perform chemical identification of the organic compounds contributing to the increased load.

This is where FTIR is useful, as it can perform chemical identification of organic substances in wastewater. If on-line TOC measurements detect an increase of organic substances, FTIR may be able to identify the source of contamination, leading to resolution of the problem. FTIR is not ideal for trace contaminants though, typically higher concentrations >5 % are required for good spectral quality. The minimum detection level is highly sample dependent. This article uses sucrose solutions of varying concentrations to explore the level at which an organic compound may be detectable with the application of processing and sampling techniques.

### ■ QATR-S Dedicated ATR Accessory

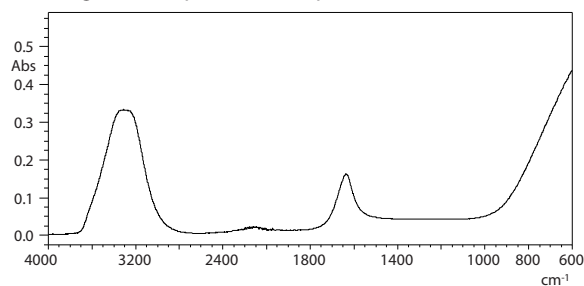
The sample condensation measurements were performed with the QATR-S single bounce ATR accessory, newly designed specifically for the IRSpirit. This accessory mounts in the sample compartment of the IRSpirit, flush on all sides, creating a wide top-sampling surface that can easily accommodate large samples without having to cut them down (Fig. 1). Both diamond and germanium crystals are available, and easily user-swappable. The swing clamp mechanism that pushes the sample against the crystal incorporates a torque limiter, preventing damage to the crystal from over-tightening. The QATR-S can be mounted only in the IRSpirit.



**Fig. 1 QATR-S Accessory Installed in IRSpirit Sample Compartment**

### ■ ATR Spectrum of Water

Fig.2 shows an ATR spectrum of water. Measurement conditions are detailed in Table 1. Water has strong absorption from 3800 – 2800  $\text{cm}^{-1}$  (OH stretch), 1800 – 1500  $\text{cm}^{-1}$  (OH bend), and <1000  $\text{cm}^{-1}$  (molecular libration). These spectral features overlap OH and NH, C=O and  $\text{CH}_2$ , and the molecular fingerprint region, making it difficult to detect minor organic components in aqueous solution.



**Fig. 2 ATR Spectrum of Water**

**Table 1 Measurement Conditions**

|              |   |
|--------------|---|
| Instrument   | : IRSpirit-L (KBr window)<br>QATR-S (Wideband diamond disk) |
| Resolution   | : 4 $\text{cm}^{-1}$  |
| Accumulation | : 45  |
| Apodization  | : Sqr Triangle  |
| Detector     | : LiTaO <sub>3</sub>  |

### Difference Spectrum Processing Method

A difference spectrum is obtained by subtracting an infrared spectrum of water from the mixture (water plus solute) spectrum. It allows for the detection of spectral features of solute molecules, if the concentration of the solute is high enough. Fig. 3 (a) and 3 (b) show the measurement results of aqueous solutions of sucrose at 0.5 and 5 % concentrations, respectively. The water and sucrose solution spectra are represented by black and red traces, whereas the difference spectra are shown in blue. The 0.5 % concentration of sucrose is too low to provide meaningful spectral features even after the subtraction of the water contribution. The difference spectrum of the 5% concentration solution does show peaks in the fingerprint region though, in the range from 1200 – 900  $\text{cm}^{-1}$ . These features are assigned to C-O stretch in alcohols, and C-C stretch in aliphatic ethers ( $> 1000 \text{ cm}^{-1}$ ) and CH<sub>2</sub> deformation modes ( $< 1000 \text{ cm}^{-1}$ ).

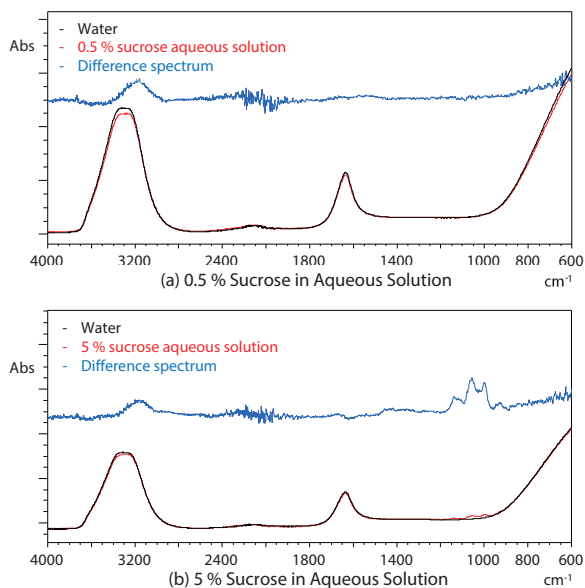


Fig. 3 Difference Spectra Processing Method, Concentration Dependence of Sucrose ID

### Condensation Sample Preparation Technique

In this sampling technique, evaporation over time is used to increase solute concentration in aqueous solutions. This is accomplished by placing a small amount of aqueous solution on an ATR crystal, and evaporating the water to leave behind an increasingly concentrated solution (Fig.4). This technique is better for chemical ID rather than quantitation, as the concentration level will be changing over the course of the experiment.

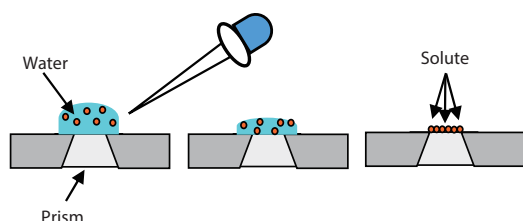


Fig. 4 Schematic of Condensation Method – Solute Concentration Increasing with Time

10  $\mu\text{L}$  of sucrose solution was measured onto the ATR crystal. The surface tension of the aqueous solution maintains the sample as a drop. The FT-ATR spectrum was measured initially, and then again at 20 and 22 minutes elapsed time. Three different sucrose concentrations were investigated in this manner: 0.1, 0.5 and 5 %.

Fig. 5 (a), (b), and (c) show the resulting spectra from these measurements, with the  $t=0$  measurement in black, the  $t=20$  min measurement in red, and the  $t=22$  minute data in blue. Not surprisingly, as time progresses and water evaporates, the spectral features of the sucrose grow more prominent. Also, the sucrose features are stronger for the more concentrated solutions.

In contrast to the difference spectrum processing method described first, the sucrose component of the 0.1 % concentration solution was ultimately resolvable, albeit after 22 minutes had elapsed and water evaporated. As this measurement was taken with a single bounce ATR configuration, it is possible that a multi-bounce accessory may enable the analysis of even lower concentration solutions, provided enough of the sample is available to ensure adequate coverage of the crystal.

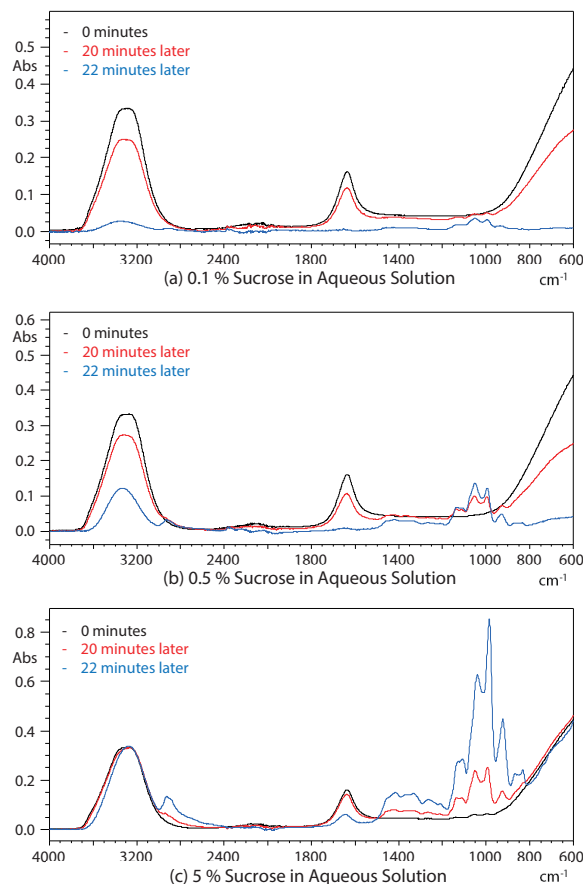


Fig. 5 Condensation Sampling Method – Time and Concentration Dependence of Sucrose ID

### Conclusion

This article demonstrates the application of processing and sampling methods to detect low-level solutes in aqueous solutions. The superior stability and sensitivity of the IRSpirit allow these techniques to successfully ID sucrose in low concentration solutions.

First Edition: Dec. 2017



For Research Use Only. Not for use in diagnostic procedure.

This publication may contain references to products that are not available in your country. Please contact us to check the availability of these products in your country.

The content of this publication shall not be reproduced, altered or sold for any commercial purpose without the written approval of Shimadzu. Shimadzu disclaims any proprietary interest in trademarks and trade names used in this publication other than its own. See <http://www.shimadzu.com/about/trademarks/index.html> for details.

The information contained herein is provided to you "as is" without warranty of any kind including without limitation warranties as to its accuracy or completeness. Shimadzu does not assume any responsibility or liability for any damage, whether direct or indirect, relating to the use of this publication. This publication is based upon the information available to Shimadzu on or before the date of publication, and subject to change without notice.

Shimadzu Corporation

[www.shimadzu.com/an/](http://www.shimadzu.com/an/)

# Application News

## No. J107

### Inductively Coupled Plasma Atomic Emission Spectrometry

## Analysis of Heavy Metals in Sewage Sludge and Sewage by ICPE-9820

### ■ Introduction

Domestic wastewater or drainage from a particular business plant can only be discharged in public waters or reused as industrial water after being cleaned up in a sewage treatment facility. If such processed water is discharged into public waters, it is required to meet effluent standards.

The increase of sewage sludge generated in the sewage treatment process, however, has become a problem. Thus, for the purposes of waste reduction and recycling, following incineration, sewage sludge is being re-used as cement material, civil engineering material, and fertilizer, etc. However, the reuse of sewage sludge, from the standpoints of environmental protection and potential health hazards, requires that its toxic heavy metal content is carefully examined.

If sewage sludge is to be discarded in a landfill, etc., it is considered to be industrial waste and is therefore subject to regulation under the Japanese Waste Disposal and Public Cleansing Law (Waste Management Law). However, if it is to be reused, it is considered to be a valuable resource, and is subject to regulation under the Japanese Fertilizer Control Act and the Soil Contamination Countermeasures Law.

To ensure that treated sewage water meets effluent standards, sewage sludge ash must be analyzed with high sensitivity to accurately quantify such elements as Pb and Cd, which may be present at trace levels up to high concentrations.

Here, using the Shimadzu ICPE-9820 multi-type ICP atomic emission spectrometer, we conducted analysis of processed water from a sewage treatment plant, in addition to sewage sludge ash. The ICPE-9820, with its original plasma emission unit, permits high-throughput analysis of elements at trace- to high-concentration levels, with high sensitivity and high accuracy.

### ■ Samples

- Treated wastewater (effluent)
- Sewage sludge ash

### ■ Sample Preparation

Treated wastewater:

After adding nitric acid and perchloric acid to 50 mL of sample, heat-digestion over a hot plate was conducted until white smoke was generated. After cooling, Y (yttrium) was added as an internal standard element, and hydrochloric acid (1 mol/L) was added to adjust the volume to 10 mL. This solution served as the analytical sample.

Sewage sludge ash:

Nitric acid was added to 10 g of sample, and heat-digestion was conducted over a hot plate. After cooling, Y (yttrium) was added as an internal standard element, and hydrochloric acid (1 mol/L) was added to adjust the volume to 100 mL. This solution served as the analytical sample.

### ■ Instrument and Analytical Conditions

For measurement, the Shimadzu ICPE-9820 multi-type ICP atomic emission spectrometer was used. The measurement conditions are shown in Table 1. The ICPE-9820 can conduct measurement while automatically switching between high sensitivity axial viewing (AX) and radial viewing (RD), suitable for high-concentration analysis. This permits simultaneous analysis of elements over a wide concentration range, from trace- to high-concentration levels, such as that found in sewage sludge ash. Further, the plasma torch is oriented vertically to reduce the memory effect. Elements that easily remain in memory, such as boron, can be analyzed efficiently using a short rinse time between analysis of sewage treated water and sewage sludge ash, for example, even if the same element is present at greatly different concentrations.

**Table 1 Analytical Conditions**

|                        |                            |
|------------------------|----------------------------|
| Instrument             | : ICPE-9820                |
| Radio frequency power  | : 1.2 kW                   |
| Plasma gas Flowrate    | : 10 L/min                 |
| Auxiliary gas Flowrate | : 0.6 L/min                |
| Carrier gas Flowrate   | : 0.7 L/min                |
| Sample introduction    | : Nebulizer 10             |
| Misting chamber        | : Cyclone chamber          |
| Plasma torch           | : Mini Torch               |
| Observation            | : Axial (AX) / Radial (RD) |

### ■ Analysis

We conducted quantitative analysis of sewage sludge ash digestion solution and treated wastewater using the internal standard method – calibration curve method. (Regarding the treated wastewater, the same quantitation was conducted by ICP-MS (Shimadzu ICPM-8500) to compare the trace values obtained in analysis.)

### [References]

- 1) Official Specifications Related to Typical Fertilizer Based on the Fertilizer Control Act (Ministry of Agriculture, Forestry and Fisheries Notification No. 284, February 22, 1986, Revised on August 8, 2012 by the Ministry of Agriculture, Forestry and Fisheries Notification No. 1985, Enforced from September 7, 2012)
- 2) Enforcement Regulations Regarding the Soil Contamination Countermeasures Law (Ministry of the Environment Ordinance No. 29, December 26, 2002)
- 3) Ordinance on Test Method for Water Quality of Sewage (Ministry of Health and Welfare/Ministry of Construction Ordinance No. 1, December 17, 1962, Revised on May 23, 2012 by the Ministry of Land, Infrastructure, Transport and Tourism/Ministry of the Environment Ordinance No. 2)
- 4) Ordinance for Determination of Effluent Standards (Prime Minister's Office Ordinance No. 35, June 21, 1971, Revised on September 4, 2013 by the Ministry of the Environment Ordinance No. 20)
- 5) JIS K0102-2013 (Industrial Wastewater Test Method)

■ Analytical Results

Table 2 shows the values (memory-related) obtained from measurement of a blank sample directly after measurement of high-concentration sample. As the blank values were reduced to low levels less than 1/1000 of the effluent standards, there was no problem in the analysis of treated trace level sewage water even after introduction of a high-concentration sewage sludge sample.

Table 3 shows the analytical results. The detection limit was less than 1/10 that of the standard values for both sewage sludge ash and treated sewage water. Even with a quantitation value of treated water at less than 1/100 of the effluent standards, the results were almost identical to those obtained by ICP-MS.

Fig. 1 shows the calibration curves for Zn. Using the combination of axial/radial observation makes it possible to increase the quantitation concentration range. Also, as the software automatically determines which calibration curve is to be applied, the time required for data evaluation following analysis can be shortened.

■ Conclusion

Both trace elements and high-concentration elements in sewage sludge ash and treated wastewater can be accurately measured with high sensitivity using the ICPE-9820.

Table 2 Blank Levels Obtained Directly After Measurement of High-Concentration Sample (Unit: mg/L)

|   | Cu               | B                | Zn             | Fe           |
|---|------------------|------------------|----------------|--------------|
| High-concentration sample solution                            | 100 (1000)       | 10 (100)         | 100 (1000)     | 2500 (25000) |
| Blank value just after injection of high-concentration sample | < 0.0005 (0.005) | < 0.0005 (0.005) | 0.0006 (0.006) | 0.01 (0.1)   |

Values in parentheses are solid conversion values (mg/kg)

Table 3 Analytical Results for Sewage Sludge Ash and Treated Sewage

|                  | Sewage Sludge Ash (mg/kg)   |  |                 |                    |                       | Treated Sewage (mg/L) |                 |                    |                             |                       |
|------------------|-----------------------------|--|-----------------|--------------------|-----------------------|-----------------------|-----------------|--------------------|-----------------------------|-----------------------|
|                  | Soil Concentration Standard | Official Standard of Ordinary Fertilizer | Detection Limit | Quantitation Value | Observation Direction | Effluent Standards    | Detection Limit | Quantitation Value | Quantitation Value (ICP-MS) | Observation Direction |
| Cd               | 150                         | 5  | 0.002           | 2.3                | AX                    | 0.1                   | 0.00004         | 0.00007            | 0.00005                     | AX                    |
| Cr               |                             | 500                                      | 0.004           | 129                | AX                    | 2                     | 0.0001          | 0.0014             | 0.0015                      | AX                    |
| Cr <sup>+6</sup> | 250                         | 0.5                                      |                 |                    |                       |                       |                 |                    |                             |                       |
| Pb               | 150                         | 100                                      | 0.02            | 59                 | AX                    | 0.1                   | 0.0004          | 0.001              | 0.0011                      | AX                    |
| B                | 4000                        |  | 0.003           | 18                 | AX                    | 10                    | 0.0001          | 0.082              | 0.084                       | AX                    |
| Cu               |                             |  | 0.006           | 621                | RD                    | 3                     | 0.0001          | 0.01               | 0.011                       | AX                    |
| Zn               |                             |  | 0.003           | 972                | RD                    | 2                     | 0.00006         | 0.051              | 0.05                        | AX                    |
| Ni               |                             | 300                                      | 0.004           | 78                 | AX                    |                       | 0.0001          | 0.019              | 0.017                       | AX                    |
| Mn               |                             |  | 0.0004          | 637                | RD                    | 10                    | 0.00001         | 0.029              | 0.028                       | AX                    |
| Fe               |                             |  | 0.002           | 22400              | RD                    | 10                    | 0.00004         | 0.098              | 0.101                       | AX                    |

Sewage sludge ash concentration = Measurement value × Dilution factor (100 mL/10 g),

Treated sewage concentration = Measurement value × Dilution factor (10 mL/50 mL)

AX: Axial view, RD: Radial view

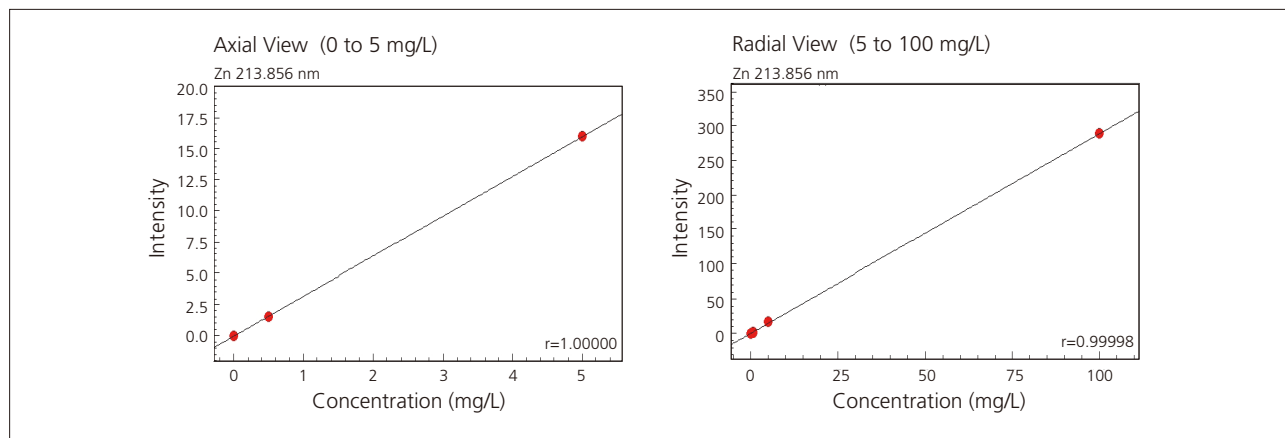


Fig. 1 Calibration Curves of Zn by Axial View and Radial View

# Application News

## No. G283

### Gas Chromatography

## Trace Impurity Analysis of Hydrogen Fuel in Fuel Cell Vehicle-Related Fields

With the development of fuel cell technology for electricity generation using hydrogen (H) as fuel, attention is turning to household fuel cell systems and fuel cell vehicles. However, one of the problems associated with fuel cells in their current state is the presence of carbon monoxide (CO) in the hydrogen fuel used in the fuel cells. Carbon monoxide adversely affects the performance of the catalyst used in the battery. This phenomenon is referred to as "catalyst poisoning," and therefore necessitates the use of high-purity hydrogen fuel. The international standard (ISO 14687-2) pertaining to hydrogen fuel for fuel cell vehicles, which went into effect in 2012, specifies that, in addition to a maximum concentration of 0.2 ppm carbon monoxide in the hydrogen, maximum concentrations are also specified for oxygen (O) and carbon dioxide (CO<sub>2</sub>) as well as hydrocarbons. In the past, analysis of impurities in hydrogen conventionally required a complex system including multiple detectors and columns, which from the standpoint of cost and maintenance, posed a significant hurdle.

The barrier discharge ionization detector (BID) is a new, universal detector that can detect almost all components, except helium (He, used as the plasma gas) and neon (Ne), with higher sensitivity than that obtained using TCD and FID detectors. This Application News introduces an example of high-sensitivity analysis of carbon monoxide in hydrogen and simultaneous analysis of impurities in hydrogen using the Tracera high-sensitivity gas chromatograph equipped with a BID detector.

### High-Sensitivity Analysis of Carbon Monoxide Using the Rt-Msieve 5A Column

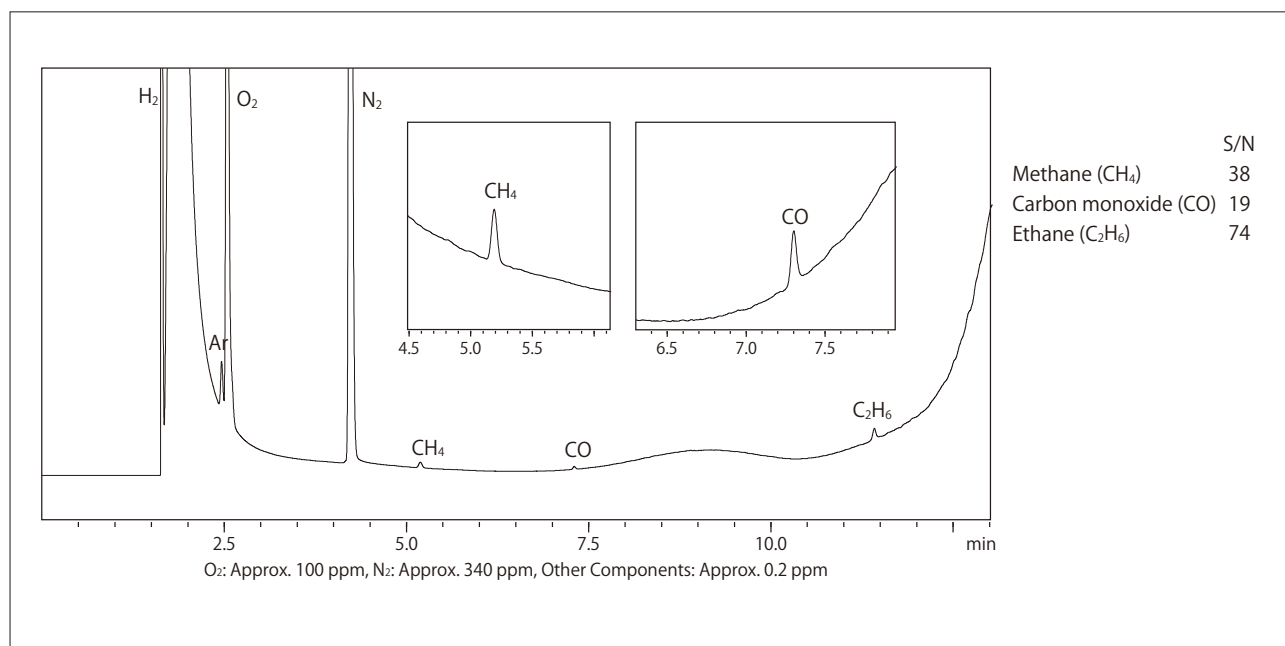
Molecular sieve 5A columns offer good separation of air components and carbon monoxide, and are a suitable type of column for the analysis of carbon monoxide.

First, a standard gas was diluted with hydrogen to adjust the concentration of each component (excluding air components) to about 0.2 ppm, and measurement of the gas was then conducted using the Rt-Msieve 5A column.

The chromatogram is shown in Fig. 1, and the analytical conditions are shown in Table 1. The lower limit of detection (S/N=3) of carbon monoxide was then calculated as 0.032 ppm.

**Table 1 Analytical Conditions for Trace Impurities in Hydrogen (Rt-Msieve 5A column)**

|                        |  |
|------------------------|--|
| Model                  | : Tracera (GC-2010 Plus + BID-2010 Plus)   |
| Column                 | : RESTEK Rt-Msieve 5A (30 m × 0.53 mm I.D., df = 50 μm) with Particle Trap 2.5 m |
| Column Temp.           | : 35 °C (2.5 min) → 20 °C/min → 250 °C → 15 °C/min → 270 °C (3.42 min)           |
| Inj. Mode              | : Split 1:7  |
| Carrier Gas Controller | : Constant linear velocity mode (He)   |
| Linear Velocity        | : 45 cm/sec  |
| Det. Temp.             | : 280 °C   |
| Discharge Gas          | : 50 mL/min (He)   |
| Inj. Volume            | : 3 mL   |



**Fig. 1 Chromatogram of Trace Impurities in Hydrogen (Rt-Msieve 5A Column)**

### Simultaneous Analysis of Impurities in Hydrogen Using the Micropacked ST Column

As carbon dioxide does not elute with the Rt-Msieve 5A column, a different system is required for analysis when carbon dioxide is among the target substances. The Micropacked ST column supports separation of inorganic gasses, including carbon dioxide and lower hydrocarbons, making it suitable for simultaneous analysis of impurities in hydrogen gas.

A standard gas was diluted with hydrogen to adjust the

component concentrations (other than air components) to about 0.2 ppm, and this gas was analyzed using the Micropacked ST column.

The resultant chromatogram is shown in Fig. 2, and the analytical conditions are shown in Table 2. The lower limit of detection of carbon monoxide was calculated as 0.078 ppm (S/N=3). Though not as good as those obtained with the Rt-Msieve 5A column, the results include detection of the maximum concentration stipulated by ISO 14687-2.

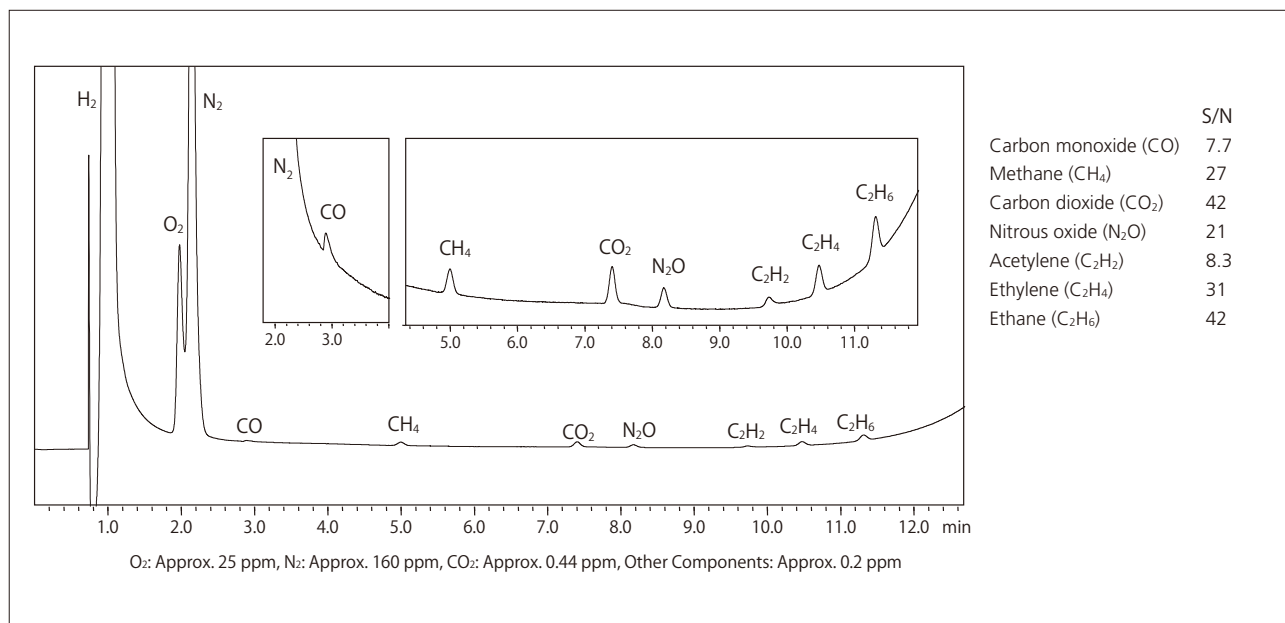


Fig. 2 Chromatogram of Simultaneous Analysis of Impurities in Hydrogen (Micropacked ST Column)

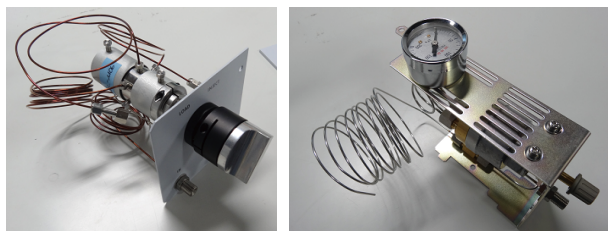
Table 2 Analytical Conditions for Simultaneous Analysis of Impurities in Hydrogen (Micropacked ST Column)

|                        |   |
|------------------------|---|
| Model                  | : Tracera (GC-2010 Plus + BID-2010 Plus)                            |
| Column                 | : Micropacked ST (2 m × 1 mm I.D.)                                  |
| Column Temp.           | : 35 °C (2.5 min) → 20 °C/min → 250 °C → 15 °C/min → 265 °C (3 min) |
| Inj. Mode              | : Split 1:4   |
| Carrier Gas Controller | : Pressure mode (He)  |
| Pressure Program       | : 226.8 kPa (2.5 min) - 15 kPa/min - 400 kPa (3.2 min)              |
| Det. Temp.             | : 280 °C  |
| Discharge Gas          | : 50 mL/min (He)  |
| Inj. Volume            | : 3 mL  |

In this analysis, the MGS-2010 gas sampler was used for the introduction of gas into the instrument; the column was connected using the SPLITTER-INJ (P/N: 221-76252-41).

The MGS-2010 is a manual gas sampler for the Tracera (GC-2010 Plus). A purge mechanism is included to reduce the leakage of peripheral air into the system. The SPLITTER-INJ refers to a special injection unit that permits split injection of the sample without requiring that it pass through the standard split/splitless injection unit.

Using the MGS-2010 for sample gas injection together with the SPLITTER-INJ unit, it is possible to quantitatively analyze trace level air components, including Oxygen (O<sub>2</sub>), Nitrogen (N<sub>2</sub>), etc., with high accuracy.



Valve Unit

Manual Flow Controller for Purge

Fig. 3 MGS-2010 Gas Sampler

# Application News

## No. G288

### Gas Chromatograph

## High-Sensitivity Simultaneous Analysis of Inorganic Gases and Light Hydrocarbons using Nexis GC-2030 Dual BID System

Analyses for inorganic gases and light hydrocarbons are implemented in a variety of fields including petrochemistry, catalysts, batteries and other resource and energy fields, and environmental fields.

The barrier discharge ionization detector (BID) installed in Nexis GC-2030 gas chromatograph is capable of detecting a wide variety of components with high sensitivity\*. Thanks to Shimadzu's proprietary barrier discharge technology, this detector features high sensitivity while maintaining the same level of stability as the previous general-purpose detectors.

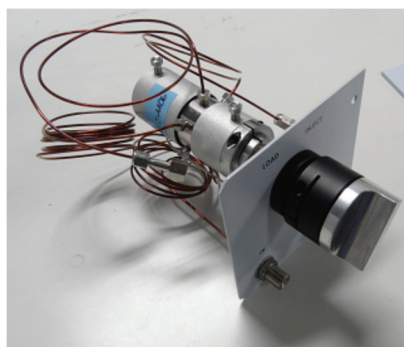
In this Application News, we introduce a high-sensitivity simultaneous analysis of inorganic gases and light hydrocarbons using Nexis GC-2030 gas chromatograph, which is equipped with two columns and two BID detectors.

\*Unable detect to helium and neon

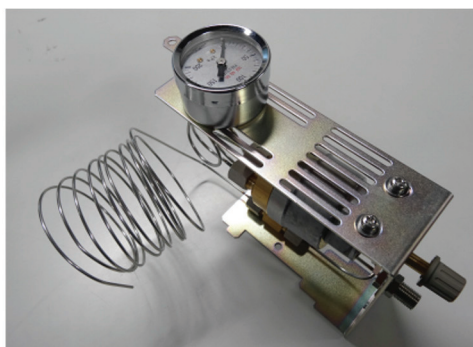
### ■ Instruments and Analytical Conditions

In this analysis, the MGS-2030 gas sampler was used for the introduction of gas into the instrument; the column was connected using the SPLITTER-INJ. The MGS-2030 is a manual gas sampler. A purge mechanism is included to reduce the leakage of peripheral air into the system. The SPLITTER-INJ refers to a special injection unit that permits split injection of the sample without requiring that it pass through the standard split/splitless injection unit. Using the MGS-2030 for sample gas injection together with the SPLITTER-INJ unit, it is possible to quantitatively analyze trace level air components, including Oxygen (O<sub>2</sub>), Nitrogen (N<sub>2</sub>), etc., with high accuracy.

T. Yokoya, T. Murata



Valve Unit



Manual Flow Controller for Purge

Fig. 1 MGS-2030 Gas Sampler

Table 1 Analytical Conditions

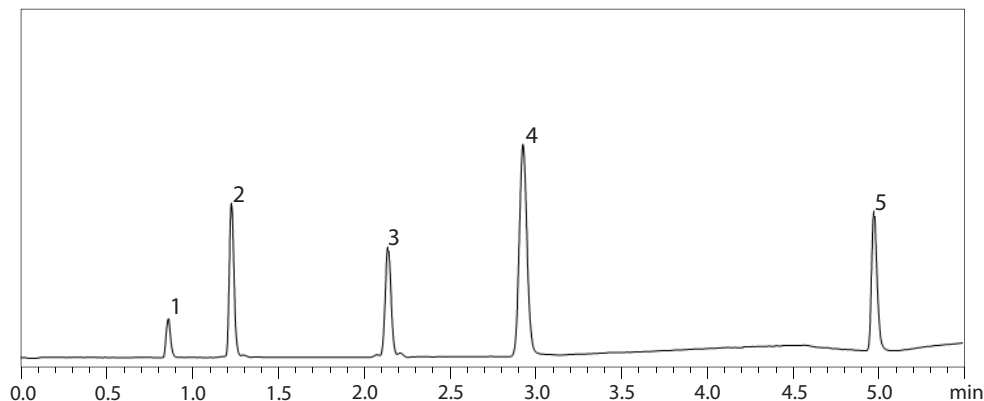
|                        |   |
|------------------------|---|
| Model                  | : Nexis GC-2030   |
| Detector               | : BID-2030  |
| Gas Sampler            | : MGS-2030  |
| Column                 | : Line1: Rt-Msieve 5A (0.32 mm I.D. × 15 m, d.f. = 30 μm)<br>Line2: Rt-Q-BOND (0.32 mm I.D. × 30 m, d.f. = 10 μm) |
| Column Temperature     | : 40 °C (3 min) - 40 °C /min - 200 °C (2 min) Total 9 min   |
| Injection Mode         | : Split 1 : 10  |
| Purge Gas              | : 3 mL/min (He)   |
| Carrier Gas Controller | : Pressure (He)   |
| Pressure Program       | : 114 kPa (5 min) - 100 kPa/min - 200 kPa (3.14 min) Total 9 min  |
| Detector Temperature   | : 280 °C  |
| Discharge Gas          | : 50 mL/min (He)  |
| Injection Volume       | : 1 mL  |

### Analysis Results

Only specific types of separation columns can be used for separation of inorganic gases and light hydrocarbons, and it is sometimes impossible to use a single column to separate all of the target components. Utilizing a dual

capillary column system, constructed using two detectors and two columns, enables faster, higher separation analysis of inorganic gases and light hydrocarbons than methods using only one column.

Line 1 Rt-Msieve5A Column



- 1: Hydrogen
- 2: Oxygen
- 3: Nitrogen
- 4: Methane
- 5: Carbon monoxide
- 6: Air + Carbon monoxide
- 7: Methane
- 8: Carbon dioxide
- 9: Ethylene
- 10: Acetylene
- 11: Ethane
- 12: Water

Line 2 Rt-Q-BOND Column

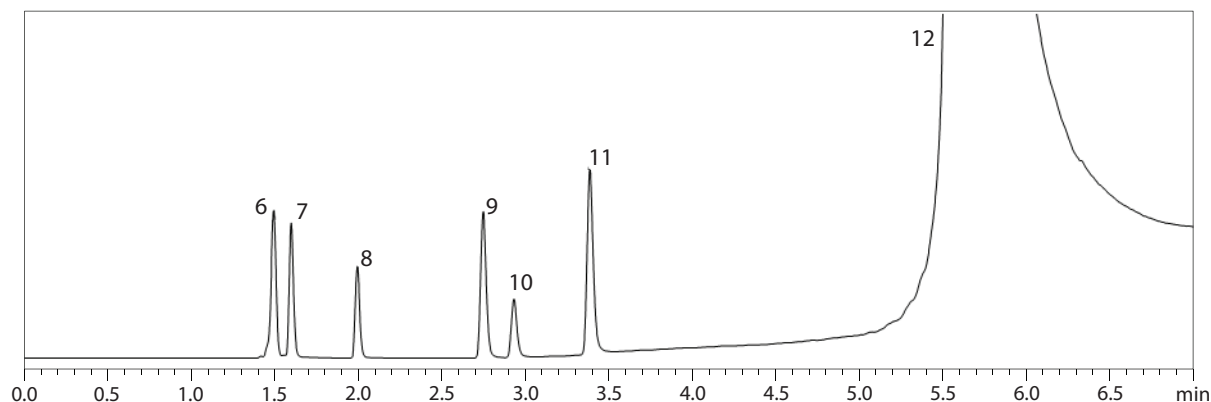


Fig. 2 Chromatogram for 5 ppm Mixed Gas\* \* Helium balance

Table 2 Repeatability of Area Values ( $\mu\text{V} \times \text{sec}$ ) for Each Component

|                 | 1     | 2     | 3     | 4     | 5     | 6     | Ave.  | RSD% |
|-----------------|-------|-------|-------|-------|-------|-------|-------|------|
| Hydrogen        | 3996  | 4010  | 4040  | 4052  | 4096  | 4105  | 4050  | 1.10 |
| Oxygen          | 15036 | 14983 | 15023 | 14973 | 15009 | 15067 | 15015 | 0.23 |
| Nitrogen        | 17021 | 16490 | 16510 | 16472 | 16566 | 16589 | 16608 | 1.25 |
| Methane         | 35142 | 35412 | 35561 | 35625 | 35784 | 35970 | 35582 | 0.81 |
| Carbon monoxide | 17143 | 17237 | 17330 | 17371 | 17441 | 17499 | 17337 | 0.76 |
| Carbon dioxide  | 25817 | 25812 | 25829 | 25779 | 25925 | 26010 | 25862 | 0.34 |
| Ethylene        | 49433 | 49439 | 49527 | 49481 | 49714 | 49833 | 49571 | 0.33 |
| Acetylene       | 37416 | 37436 | 37446 | 37440 | 37604 | 37717 | 37510 | 0.33 |
| Ethane          | 67092 | 67187 | 67263 | 67357 | 67579 | 67701 | 67363 | 0.35 |

First Edition: Jun. 2017



For Research Use Only. Not for use in diagnostic procedure.

This publication may contain references to products that are not available in your country. Please contact us to check the availability of these products in your country.

The content of this publication shall not be reproduced, altered or sold for any commercial purpose without the written approval of Shimadzu. Company names, product/service names and logos used in this publication are trademarks and trade names of Shimadzu Corporation or its affiliates, whether or not they are used with trademark symbol "TM" or "®". Third-party trademarks and trade names may be used in this publication to refer to either the entities or their products/services. Shimadzu disclaims any proprietary interest in trademarks and trade names other than its own.

The information contained herein is provided to you "as is" without warranty of any kind including without limitation warranties as to its accuracy or completeness. Shimadzu does not assume any responsibility or liability for any damage, whether direct or indirect, relating to the use of this publication. This publication is based upon the information available to Shimadzu on or before the date of publication, and subject to change without notice.

Shimadzu Corporation

www.shimadzu.com/an/



# Application News

## No. G292

### Gas Chromatograph

## Analysis of Lower Aliphatic Aldehydes using Nexis GC-2030

Lower aliphatic aldehydes are known to be associated with sick building syndrome. Thus various regulations require strict control of their concentrations. A common method of analyzing lower aliphatic aldehydes is to utilize 2,4-dinitrophenylhydrazine (DNPH) derivatization. Trace level analysis of these compounds is then enabled by using a flame thermionic detector (FTD/NPD).

In this applications news, methods for collecting aldehydes in atmospheric air, extraction and elution using commercially available cartridges and the analysis of lower aliphatic aldehydes using GC-2030 with FTD-2030 are described.

K. Gregory, K. Kawamoto



Fig. 1 Nexis GC-2030

### Sample Collection Method

In this set-up, two commercially available cartridges saturated with 2,4-dinitrohydrazine are connected in series. The pump flow rate is set to about 0.1 L / min, and air sample is collected for 24 hours continuously. The amount of air extraction can be measured by using an integrating flow meter. In order to prevent decomposition of aldehyde-DNPHs by atmospheric ozone, install an ozone scrubber in front of the collection cartridge (Fig. 2).

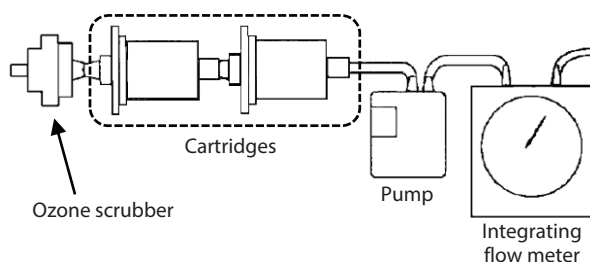


Fig. 2 Schematic Diagram of Collection Method

### Cartridge Elution Method

The aldehydes react in the cartridge to form aldehyde-DNPHs and is eluted with acetonitrile. During elution, unreacted DNPH which may interfere with the analysis may also be eluted. This can be removed by using a cation exchange resin. Since acetonitrile can also be detected by FTD, the eluate should further be extracted with ethyl acetate (Fig. 3).

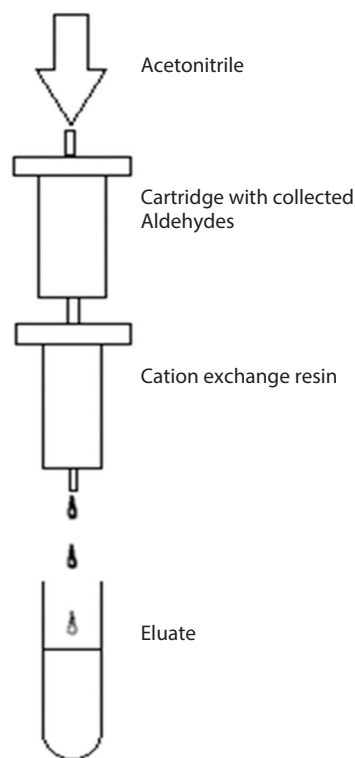
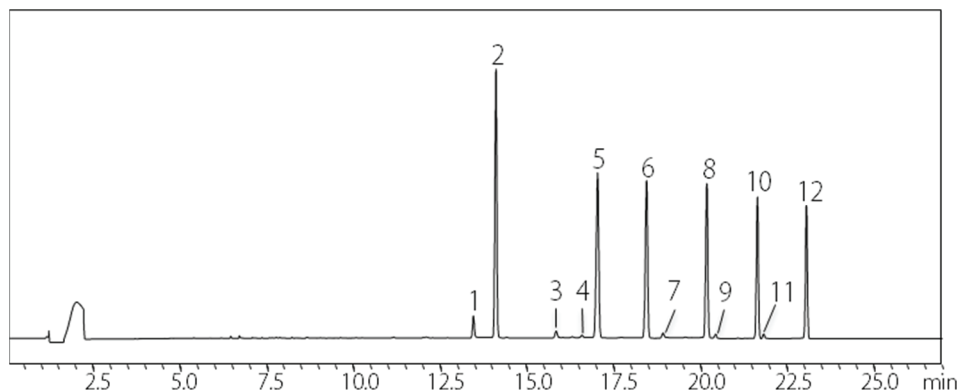


Fig. 3 Schematic Diagram of Elution Method Collection Method

### Note

Trace amounts of aldehydes may also be present in containers, cartridges and in some reagents. Therefore, it is important to always analyze a blank before the actual sample. Depending on the cleanliness of the environment where extraction is performed, it is also possible that unwanted contaminants can make their way to the sample extract.

## ■ Analysis Results



- 1 : acetaldehyde-DNPH1
- 2 : acetaldehyde-DNPH2
- 3 : propionaldehyde-DNPH1
- 4 : i-butylaldehyde-DNPH1
- 5 : propionaldehyde-DNPH2
- 6 : i-butylaldehyde-DNPH2
- 7 : n-butylaldehyde-DNPH1
- 8 : n-butylaldehyde-DNPH2
- 9 : i-valeraldehyde-DNPH1
- 10 : i-valeraldehyde-DNPH2
- 11 : n-valeraldehyde-DNPH1
- 12 : n-valeraldehyde-DNPH2

**Fig. 4 Chromatogram for DNPH-Derivatized Lower Aliphatic Aldehydes (1 µg/mL Ethyl Acetate Solution)**

\* Stereoisomers exist for C2 and subsequent aldehydes-DNPH

## ■ Instruments Used and Analytical Conditions

|                           |  |
|---------------------------|--|
| Gas Chromatograph         | Nexis GC-2030  |
| Flame Thermionic Detector | FTD-2030   |
| Autosampler               | AOC-20i  |
| Software                  | LabSolutions LC/GC   |
| Injection Unit Temp.      | 200 °C   |
| Carrier Gas               | He (99.999 %)  |
| Carrier Gas Control       | Constant linear velocity (41.7 cm/sec, purge flowrate: 3 mL/min)                     |
| Injection Mode            | Splitless (Sampling time: 1 min; then split (1:30))                                  |
| Sample Injection Volume   | 1 mL   |
| Column                    | Rtx <sup>®</sup> -5 (0.25 mm I.D. × 30 m, d.f. 0.25 mm)                              |
| Column Temp.              | 80 °C (1 min) - 20 °C/min - 200 °C (10 min) - 5 °C/min - 250 °C (0 min) Total 27 min |
| Detector Temp.            | 280 °C   |
| Current                   | 1.00 pA  |
| Detector Gas Flowrate     | H <sub>2</sub> : 1.5 mL/min, Air: 145 mL/min   |
| Makeup Gas Flowrate       | 27.5 mL/min (He)   |

First Edition: Jun. 2017



**For Research Use Only. Not for use in diagnostic procedure.**

This publication may contain references to products that are not available in your country. Please contact us to check the availability of these products in your country.

The content of this publication shall not be reproduced, altered or sold for any commercial purpose without the written approval of Shimadzu. Company names, product/service names and logos used in this publication are trademarks and trade names of Shimadzu Corporation or its affiliates, whether or not they are used with trademark symbol "TM" or "®". Third-party trademarks and trade names may be used in this publication to refer to either the entities or their products/services. Shimadzu disclaims any proprietary interest in trademarks and trade names other than its own.

The information contained herein is provided to you "as is" without warranty of any kind including without limitation warranties as to its accuracy or completeness. Shimadzu does not assume any responsibility or liability for any damage, whether direct or indirect, relating to the use of this publication. This publication is based upon the information available to Shimadzu on or before the date of publication, and subject to change without notice.

Shimadzu Corporation

[www.shimadzu.com/an/](http://www.shimadzu.com/an/)

# Application News

## No. G300

### Gas Chromatography

## Analysis of SF<sub>6</sub> Insulation Gas Using a GC-BID System

Sulfur hexafluoride (SF<sub>6</sub>) is an extremely stable gas with excellent dielectric properties and is used in various fields. Applications include tracer gas as well as insulation gas used in electrical equipment such as gas-insulated transformers and circuit breakers. On the other hand, SF<sub>6</sub> is also known to be a highly potent greenhouse gas and was identified as an emission reduction target in the Kyoto Protocol at the COP3 meeting. Conventional analysis of SF<sub>6</sub> employs an electron capture detector (ECD) which is capable of detecting electrophilic compounds with high sensitivity. However, the quantitation accuracy in the high-concentration range and the hassle of procedures necessary due to the use of radioisotopes have been an issue. Shimadzu's barrier discharge ionization detector (BID) offers high-sensitivity detection of almost all components. Utilizing proprietary barrier discharge technology, the detector achieves both the same stability as general conventional detectors and high sensitivity.

This article introduces example analyses of SF<sub>6</sub> and SF<sub>6</sub> decomposition products.

R. Kubota, S. Uchiyama

### ■ Analysis of Impurities in SF<sub>6</sub>

SF<sub>6</sub> is used as an insulation gas in various electrical equipment and requires purity analysis for quality control to maintain insulation properties and when recycling the gas. Fig. 1 shows the result of analyzing impurities in SF<sub>6</sub>

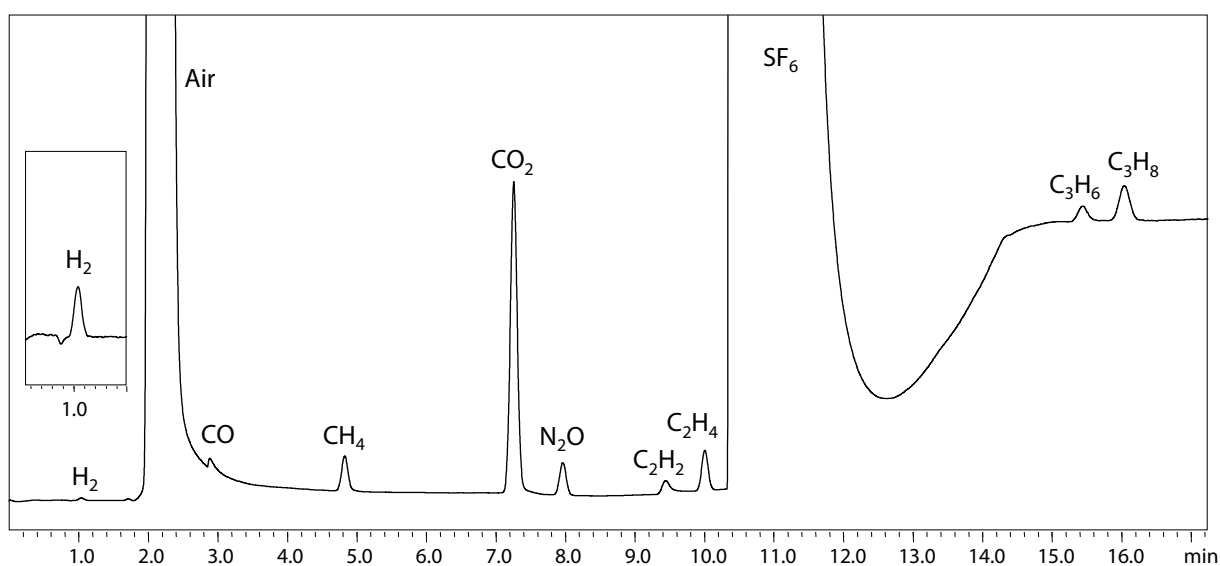
using a BID. The primary component SF<sub>6</sub> is saturated, but did not influence the quantitation accuracy of surrounding components, showing that high-sensitivity batch analysis of impurities including inorganic gas and lower hydrocarbons was successful. (Under the analytical conditions using this type of column, C<sub>2</sub>H<sub>6</sub> is overlapped by SF<sub>6</sub>.)

The concentrations of impurities found in the SF<sub>6</sub> sample are as follows.

|   |   |   |
|---|---|---|
| H <sub>2</sub> : 0.9 ppm                | CO: 0.9 ppm                             | CH <sub>4</sub> : 1.7 ppm               |
| CO <sub>2</sub> : 21 ppm                | N <sub>2</sub> O: 2.0 ppm               | C <sub>2</sub> H <sub>2</sub> : 2.4 ppm |
| C <sub>2</sub> H <sub>4</sub> : 1.4 ppm | C <sub>3</sub> H <sub>6</sub> : 1.0 ppm | C <sub>3</sub> H <sub>8</sub> : 1.0 ppm |

**Table 1 Measurement Conditions**

|               |   |
|---------------|---|
| Model         | : Nexis™ GC-2030  |
| Detector      | : BID-2030  |
| Inj. Mode     | : Split 1:4   |
| Inj.Temp.     | : 150 °C  |
| Carrier Gas   | : 7 mL/min (constant flow rate)   |
| Column        | : MICROPACKED-ST 2.0 m × 1.0 mm I.D.<br>(Input 250 m × 0.50 mm I.D. and df = 10 μm for flow rate calculation) |
| Column Temp.  | : 35 °C (2.5 min) – 20 °C/min – 250 °C (0 min) –<br>15 °C/min – 265 °C (3.0 min)                              |
| Purge flow    | : 3 mL/min  |
| Det. Temp.    | : 280 °C  |
| Discharge Gas | : 50 mL/min (He)  |
| Inj. Volume   | : 3.0 mL (MGS-2030)   |



**Fig. 1 Analysis of Impurities in SF<sub>6</sub>**

### ■ Analysis of Trace SF<sub>6</sub> in the Atmosphere

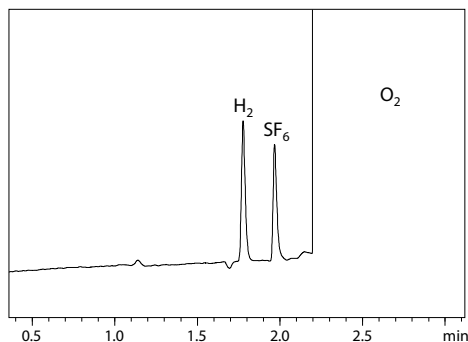
Since SF<sub>6</sub> is a potent greenhouse gas and its emission into the atmosphere must be avoided, leak tests for insulation gas from electrical equipment and residue tests after collecting gas may require analysis of trace amounts of SF<sub>6</sub>. Table 2 lists the measurement conditions and Fig. 2 shows the result of analyzing trace SF<sub>6</sub> in the atmosphere.

SF<sub>6</sub> at a concentration of 0.1 ppm was detected (S/N = 24<sup>\*1</sup>) and favorable linearity was obtained in the range from 0.1 to 50 ppm (R<sup>2</sup> = 0.9998).

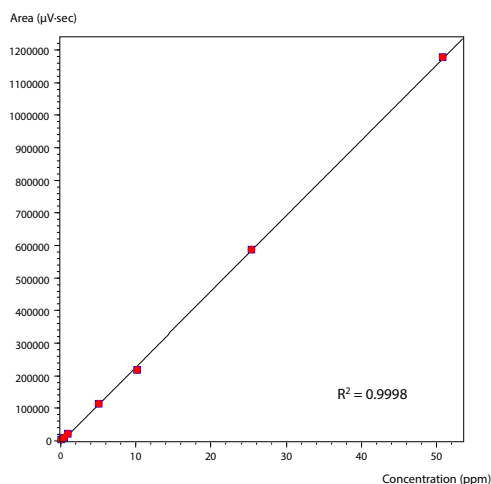
\*1 Determined by calculating noise from the baseline between 0.5 and 1.5 min.

**Table 2 Measurement Conditions**

|               |  |
|---------------|--|
| Model         | : Nexis™ GC-2030   |
| Detector      | : BID-2030   |
| Inj. Mode     | : Split 1:7  |
| Inj.Temp.     | : 150 °C   |
| Carrier Gas   | : 45 cm/sec (constant linear velocity)   |
| Column        | : SH-Rt™-Msieve 5A (0.53 mm I.D.×30 m, d.f.50 μm)                              |
| Column Temp.  | : 35 °C (2.5 min) – 20 °C/min – 250 °C (0 min) – 15 °C/min – 270 °C (3.42 min) |
| Purge flow    | : 3 mL/min   |
| Det. Temp.    | : 280 °C   |
| Discharge Gas | : 50 mL/min (He)   |
| Inj. Volume   | : 3.0 mL (MGS-2030)  |



**Fig. 2 Analysis of Trace SF<sub>6</sub> (0.1 ppm) in the Atmosphere**



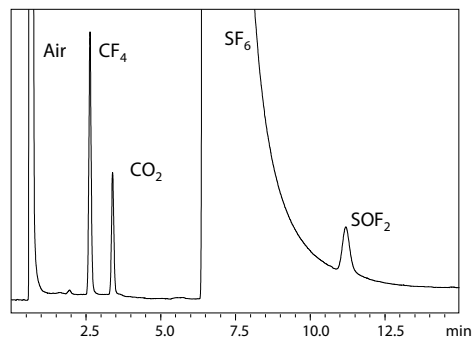
**Fig. 3 Linearity of SF<sub>6</sub> in the Atmosphere (0.1 to 50 ppm)**

### ■ Analysis of SF<sub>6</sub> Decomposition Gas

SF<sub>6</sub> is used as an insulation gas in circuit breakers. Breakers are installed on electrical grids to shut off high voltages that may occur due to causes such as lightning strikes. When performing maintenance on such breakers, SF<sub>6</sub> decomposition gases are analyzed to judge the degradation level of insulation gas. Table 3 lists the measurement conditions and Fig. 4 shows the results of an example analysis of CF<sub>4</sub> and SOF<sub>2</sub> which are SF<sub>6</sub> decomposition gases. Sample injection using a gas sampler and a gas-tight syringe is possible on the same system, allowing analysis of gas samples in various forms and concentrations.

**Table 3 Measurement Conditions**

|               |  |
|---------------|--|
| Model         | : Nexis™ GC-2030   |
| Detector      | : BID-2030   |
| Inj. Mode     | : Split 1:4  |
| Inj.Temp.     | : 150 °C   |
| Carrier Gas   | : 7 mL/min (constant flow rate)  |
| Column        | : MICROPACKED-ST 1.0 m × 1.0 mm I.D. (Input 1,250 m × 0.50 mm I.D. and df = 15 μm for flow rate calculation) |
| Column Temp.  | : 50 °C (1.0 min) – 25 °C/min – 150 °C (0 min) – 5 °C/min – 200 °C (0 min)                                   |
| Purge flow    | : 3 mL/min   |
| Det. Temp.    | : 280 °C   |
| Discharge Gas | : 50 mL/min (He)   |
| Inj. Volume   | : 200 μL (gas-tight syringe)   |



**Fig. 4 Analysis of SF<sub>6</sub> Decomposition Gases (CF<sub>4</sub>: 310 ppm, SOF<sub>2</sub>: 107 ppm)**

Nexis is a trademark of Shimadzu Corporation.  
Rt is a trademark of Restek Corporation.

Gas Chromatograph

# *Nexis* GC-2030



## The Next Industry Standard

Nexis GC-2030, Shimadzu's premier gas chromatograph, offers a modern approach to a classic chromatographic technique. Designed with the user in mind, new innovative features, exceptional performance and high-throughput capabilities will elevate your lab to the next level.

### Designed with the Analyst in Mind

An advanced interface enables intuitive operation with clear graphics. Shimadzu's latest tool-free maintenance technology makes daily maintenance easy.

### World's Highest\* Sensitivity and Reproducibility

Achieves the world's highest\* sensitivity on all of the detectors, such as FID and BID. The advanced flow controller (AFC) enhances reliability with excellent repeatability.

### Exceptional Expandability and Productivity

Nexis GC-2030 can be customized to meet a customer's specific requirements and needs. Options and functions to use hydrogen carrier gas safely in high-speed analysis maximize analysis productivity.



## Information at Your Finger-tips

Analysts will benefit from the touch panel interface, which features clear graphics that display information instantly whenever needed. The user-friendly interface leaves the operator free to focus on obtaining optimal analytical results.

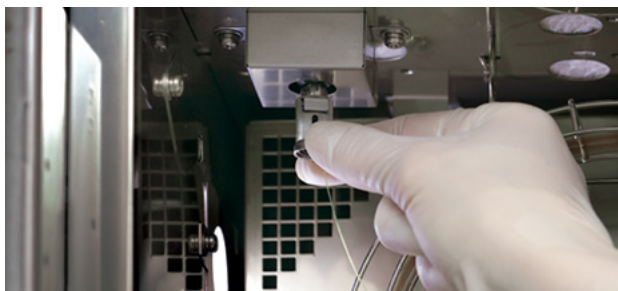
Main settings controllable via the touch panel on the GC unit:

- Analytical conditions
- Self-diagnostics
- Automatic carrier gas leak check
- Chromatogram display, etc.

## Tool-free Column Installation

ClickTek connectors\* make tool free column installation a snap. The click sensation felt when finished attaching the column provides a more reliable connection and ensures a better seal under all operating conditions.

\* Optional



ClickTek Connector

## One Touch Inlet Maintenance

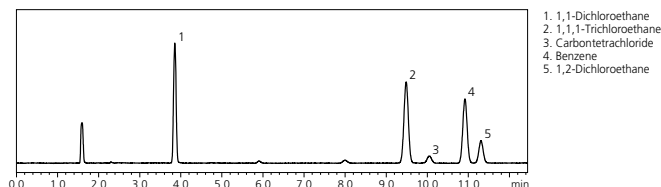
The injection port can be opened or closed without tools by simply sliding the ClickTek lever. Replace the insert, slide the lever and feel the click for a leak-free install every time.



ClickTek Nut

## High-Sensitivity Detectors Support a Wide Variety of Analyses

The jet and collector structure on the flame ionization detector (FID-2030) has been optimized to provide improved performance. Noise levels were also decreased by improving the stability of the signal processor and flow controller. This results in the world's most sensitive FID. This makes the Nexis GC-2030 the best choice to measure residual solvents in pharmaceuticals.



Analysis of Trace Residual Solvents in Pharmaceuticals using Head Space GC, Class 1 Standard Solution

## GC Systems Customized for Specific Needs

The Nexis GC-2030 provides powerful support for configuring custom GC systems tailored to user needs. These systems are adjusted and tested at the factory for the given application before shipment, so they are ready to use for measurements as soon as they are delivered.

That means no time is required for developing methods after the system arrives. Two TCD detectors and one FID detector can be installed at the same time. An optional valve box can be added to control up to eight valves from the original four.

## Examples of System GC Configurations

### Gasoline analysis system

This system is able to measure specific substances in gasoline, such as oxygenates.

### Natural gas analysis system

This system is able to analyze components in natural gas, such as shale gas.

### Inorganic gas analysis system

This system is able to measure hydrogen and various other inorganic gases.

### Hydrocarbon analysis system

This system is able to measure hydrocarbons that are generated, such as from catalyst reactions.

### Refinery gas analysis system

This system is able to analyze components in gas from petroleum refineries.

### Public utility natural gas analysis system

This system is able to calculate calorific values from measurements of natural gas.

\*As of May 2017, according to a Shimadzu survey



Shimadzu Corporation

[www.shimadzu.com/an/](http://www.shimadzu.com/an/)

**For Research Use Only. Not for use in diagnostic procedures.**

This publication may contain references to products that are not available in your country. Please contact us to check the availability of these products in your country.

Company names, product/service names and logos used in this publication are trademarks and trade names of Shimadzu Corporation or its affiliates, whether or not they are used with trademark symbol "TM" or "®". Third-party trademarks and trade names may be used in this publication to refer to either the entities or their products/services. Shimadzu disclaims any proprietary interest in trademarks and trade names other than its own.

The contents of this publication are provided to you "as is" without warranty of any kind, and are subject to change without notice. Shimadzu does not assume any responsibility or liability for any damage, whether direct or indirect, relating to the use of this publication.

# Application News

## No.g01

### Transportable Gas Analyzer

## Evaluation of a Catalyst Used in the Production of Fuel Cell Hydrogen with CGT-7100

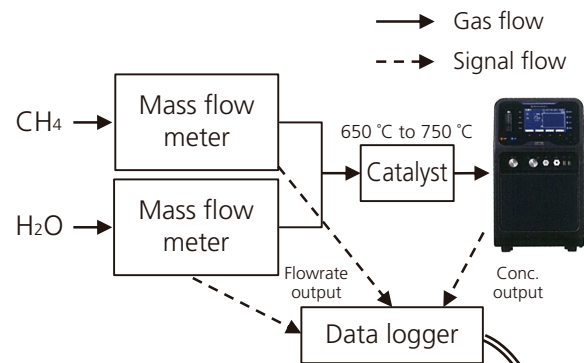
Steam reforming is a method used to produce hydrogen gas needed for fuel cells, a green energy technology that has attracted attention in recent years. Steam reforming introduces a high temperature catalyst to a mixture of steam and raw materials such as methane or ethanol to produce hydrogen gas. Evaluation of the catalyst used during steam reforming involves an assessment of catalytic performance and how catalyst degradation is affected by different reaction temperatures, and is achieved by monitoring changes in the concentration of product components, such as CO and CO<sub>2</sub>. The CGT-7100 comes with the ability to detect up to two components out of CO, CO<sub>2</sub>, and CH<sub>4</sub>, and has built-in sample pretreatment units, which allows for direct and real-time measurement of sample gases without the need for connection of separate pretreatment systems. This article describes an example evaluation of a catalyst by CO and CO<sub>2</sub> measurement.

### Measurement Method

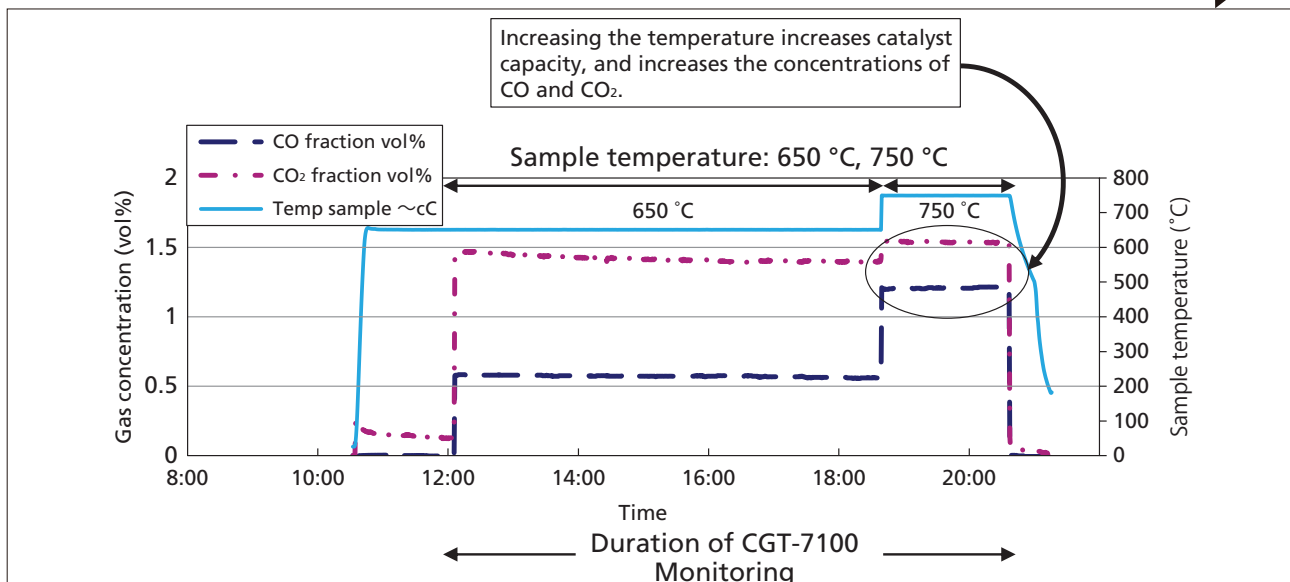
Standard methane gas and steam mixed at fixed flowrates were passed through a high temperature chamber containing a catalyst. Gas discharged from the chamber was cooled to room temperature, liquid generated was drained away, and then gas was introduced to the CGT-7100, which was used to measure concentrations of CO and CO<sub>2</sub> in the exhaust gas sample. A single experiment was performed over a period of between 6 and 10 hours, during which time the change in CO and CO<sub>2</sub> concentration was monitored continuously. This experimental method is used to confirm how the state of degradation of a reforming catalyst is affected by different catalyst temperatures. It shows that increasing the temperature of the catalyst increases its reforming capacity.

**Table 1 Analytical Conditions**

|                     |   |
|---------------------|---|
| Analyzer            | : CGT-7100                              |
| Measured Components | : CO, CO <sub>2</sub>                   |
| Measurement Range   | : CO 10 vol%<br>CO <sub>2</sub> 15 vol% |
| Sample Gas Flowrate | : 100 mL/min                            |



**Fig. 1 System Diagram**



**Fig. 2 Results**

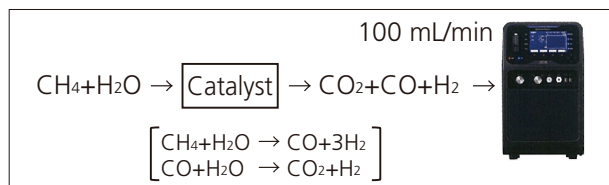


Fig. 3 Reaction Formula

The CGT-7100 can be used not only to measure combustion exhaust gases, but also for research into improving fuel cell efficiency and lifespan by monitoring the concentration of methane gas that is part of natural gas, and by measuring the concentration of the impurity carbon monoxide. Furthermore, the CGT-7100 can also be used for research into catalysts used in fuel reforming systems that produce hydrogen gas from natural gas by measuring carbon monoxide and carbon dioxide present at very low flowrates but high concentrations.



Fig. 4 CGT-7100 Main Unit

Table 2 Specifications of CGT-7100 Standard Types 1 to 3

|                                | Type 1   | Type 2   | Type 3   |
|--------------------------------|--|--|--|
| Measured Components            | CO, CO <sub>2</sub>  | CO, CH <sub>4</sub>  | CO, CO <sub>2</sub>  |
| Measurement Range              | CO: 0 – 1000/5000 ppm<br>CO <sub>2</sub> : 0 – 5/15 vol%   | CO: 0 – 5 vol%<br>CH <sub>4</sub> : 0 – 20 vol%                                | CO: 0 – 10/20 vol%<br>CO <sub>2</sub> : 0 – 10/20 vol%       |
| Measurement Principle          | CO, CO <sub>2</sub> , CH <sub>4</sub> : Single light source dual beam non-dispersive infrared absorption method (ratio photometry) |  |  |
| Repeatability                  | Within ± 0.5 % of full scale   |  |  |
| Zero Drift                     | Within ± 1 % of full scale per day   |  |  |
| Span Drift                     | Within ± 1 % of full scale per day   |  |  |
| Linearity                      | Within ± 2 % of full scale   | CO: Within ± 2 % of full scale<br>CH <sub>4</sub> : Within ± 3 % of full scale | Within ± 2 % of full scale                                   |
| Response Time (Td + T90)       | CO, CO <sub>2</sub> , CH <sub>4</sub> : Selectable from 15, 30, or 60 seconds  |  | Less than 3 minutes (at a sample gas flowrate of 100 mL/min) |
| Sample Gas Collection Flowrate | Approx. 2.5 L/min (The gas flowrate for the sample cell is 1.0 L/min.)   |  | 100 to 400 mL/min (variable)                                 |
| Transmission Output            | 0 to 1 V DC, 3-channel insulated output (non-insulated between channels)   |  |  |
| Wireless Signal Output         | Yes  |  |  |
| Data Storage to External Media | Allows data in CSV format to be saved to a USB flash drive.  |  |  |
| Permitted Ambient Temperature  | 5 to 40 °C. Should be protected from direct sunlight and radiant heat.   |  |  |
| Power Requirements             | 100 V AC, 50/60 Hz, 130 VA   |  |  |
| Dimensions                     | W260 × D420 × H452 mm (Excluding protrusions)  |  |  |
| Weight (Main unit)             | Approx. 16 kg  |  |  |
| External drain separator       | Yes  | No   |  |

Please contact Shimadzu regarding analyte component combinations and measurement ranges not mentioned above.



# Application News

## No. C100

### Liquid Chromatography Mass Spectrometry

## Quantitative Analysis of Pyrethroids in Soil and Sediment Using the Shimadzu LCMS-8050 Triple Quadrupole Mass Spectrometer

Pyrethroid pesticides are used widely around the world as agricultural and household insecticides. Synthetic pyrethroids are slightly soluble in water and easily adsorbed in soil. In recent years, pyrethroid residues have been confirmed in soil and sediment in both agricultural and urban areas. Pyrethroids, while posing little danger to humans, exhibit a high toxicity to aquatic organisms and insects, making their impact on the ecosystem a matter of concern. Therefore, there is

a need for a sensitive technique which can rapidly measure pyrethroid pesticides in soil and sediment. Due to their low polarity, pyrethroid pesticides are typically measured by GC and GC-MS, however this Application News demonstrates simultaneous positive- and negative-ion mode analysis of 14 pyrethroid pesticides using LC-MS/MS with electrospray ionization (ESI).

### MRM Analysis of Standards and Generation of Calibration Curves

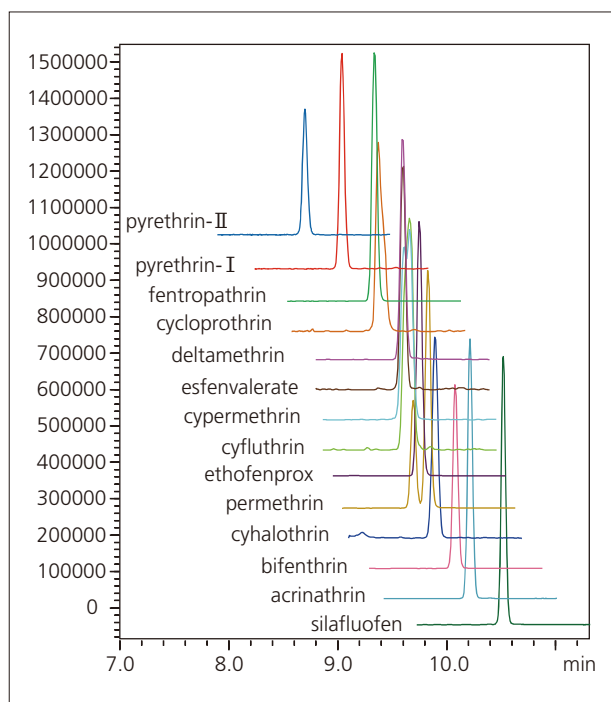


Fig. 1 MRM Chromatograms of Pyrethroids

Table 1 MRM Transitions and Calibration Curves of Pyrethroids

| Compound Name    | Polarity | Precursor (m/z) | Product (m/z) | Calibration Curve Range (µg/L) | r <sup>2</sup> |
|------------------|----------|-----------------|---------------|--------------------------------|----------------|
| Pyrethrin-I      | +        | 329.20          | 161.10        | 0.5 - 500                      | 0.9996         |
| Pyrethrin-II     | +        | 373.20          | 161.20        | 0.5 - 500                      | 0.9997         |
| Fenprothrin      | +        | 367.20          | 125.20        | 0.02 - 100                     | 0.9993         |
| Cycloprothrin    | +        | 498.90          | 181.10        | 0.5 - 100                      | 0.9991         |
| Deltamethrin     | +        | 522.80          | 280.90        | 0.05 - 100                     | 0.9992         |
| Esfenvalerate    | +        | 437.10          | 167.30        | 0.5 - 100                      | 0.9990         |
| Cypermethrin     | +        | 433.10          | 191.10        | 0.05 - 100                     | 0.9986         |
| Cyfluthrin       | +        | 450.90          | 191.00        | 0.5 - 100                      | 0.9976         |
| Ethofenprox      | +        | 394.20          | 177.30        | 0.01 - 100                     | 0.9993         |
| trans-Permethrin | +        | 408.10          | 183.30        | 0.02 - 100                     | 0.9996         |
| cis-Permethrin   | +        | 408.10          | 183.30        | 0.02 - 100                     | 0.9994         |
| Cyhalothrin      | +        | 467.10          | 225.10        | 0.1 - 100                      | 0.9993         |
| Bifenthrin       | +        | 440.00          | 181.20        | 0.02 - 100                     | 0.9995         |
| Acrinathrin      | -        | 540.10          | 372.20        | 0.1 - 100                      | 0.9994         |
| Silafluofen      | +        | 426.20          | 287.10        | 0.01 - 100                     | 0.9999         |

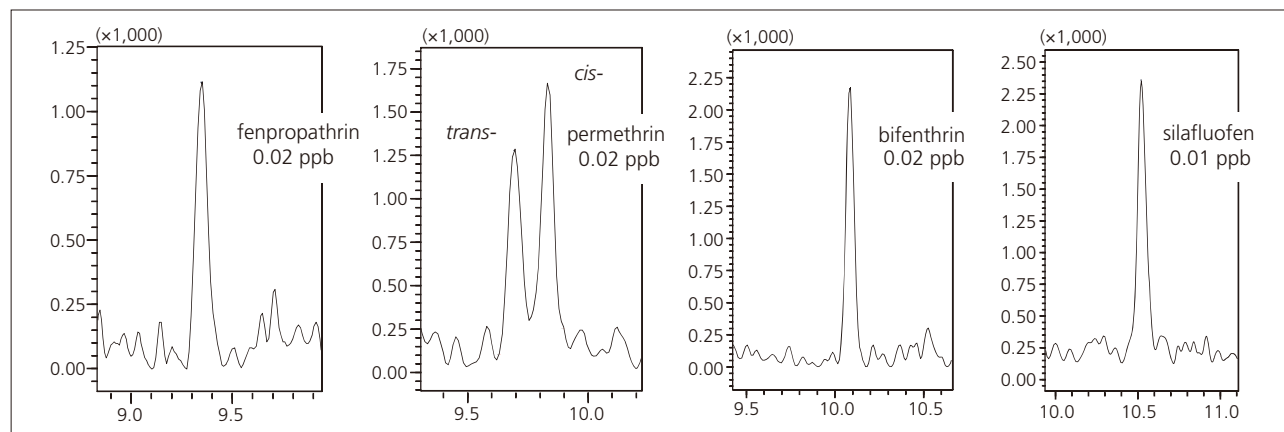


Fig. 2 MRM Chromatograms at Pyrethroid LOQs

### Sample Preparation for Soil and Sediment Using QuEChERS Method

Soil samples are generally prepared using solid-phase extraction, however, this process can be both time-consuming and labor-intensive. In this application, the easy pretreatment method referred to as QuEChERS (Quick, Easy, Cheap, Effective, Rugged, Safe), typically used for analysis of residual pesticides in food, was used for the pretreatment of soil and sediment samples. Fig. 3 shows the protocol employed to pretreat these soil and sediment samples. The combined acetonitrile extraction and cleanup process requires only 15 minutes per sample to complete.

### Recoveries Using Actual Samples

A mixed pesticide standard solution was added to soil and sediment solutions respectively to obtain a concentration of 10 ppb before or after pretreatment was conducted by the QuEChERS method, and recovery tests were then conducted. Good recoveries of 70 to 120 % were obtained for both soil and sediment samples, as shown in Fig. 4.

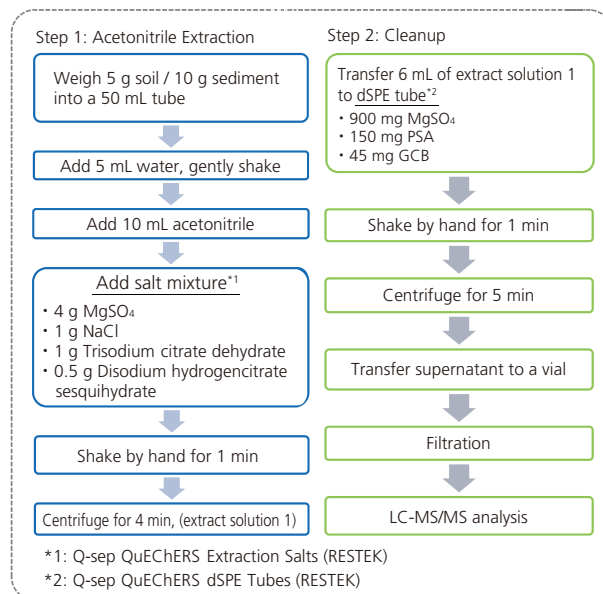


Fig. 3 Sample Preparation Using QuEChERS Method

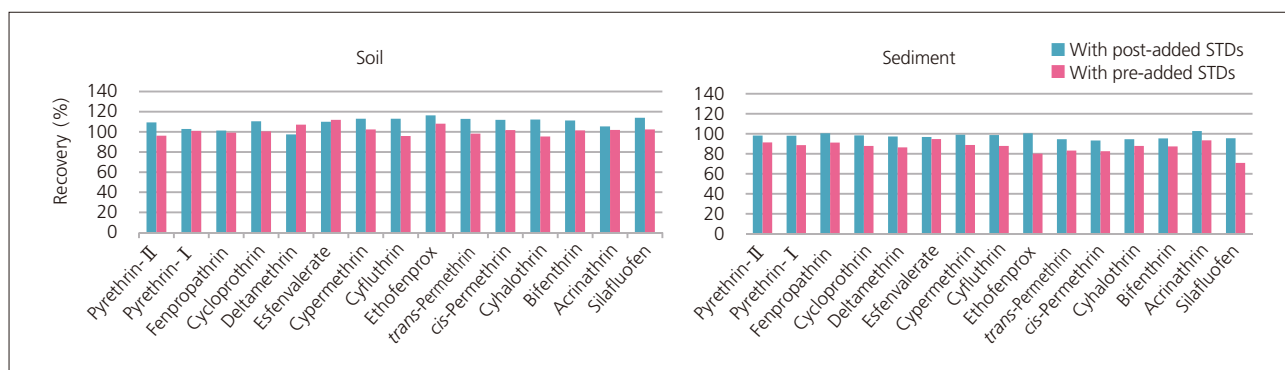


Fig. 4 Recoveries from Soil and Sediment

Table 2 Analytical Conditions

|                          |   |
|--------------------------|---|
| Column                   | : Phenomenex Kinetex 2.6 μm PFP 100Å (100 mm × 2.1 mm I.D.)     |
| Mobile Phase A           | : 5 mM Ammonium Acetate - Water                                 |
| Mobile Phase B           | : Methanol  |
| Time Program             | : 40 %B (0 min) → 100 %B (10 - 12 min) → 40 %B (12.01 - 15 min) |
| Flowrate                 | : 0.2 mL/min.   |
| Injection Volume         | : 1 μL  |
| Oven Temperature         | : 40 °C   |
| Ionization Mode          | : ESI (Positive / Negative)                                     |
| Probe Voltage            | : +4.0 kV / -3.0 kV   |
| Nebulizing Gas Flow      | : 3.0 L/min.  |
| Drying Gas Flow          | : 15.0 L/min.   |
| Heating Gas Flow         | : 15.0 L/min.   |
| Interface Temperature    | : 100 °C  |
| DL Temperature           | : 100 °C  |
| Block Heater Temperature | : 400 °C  |

# Application News

## No. L503

### Supercritical Fluid Extraction / Chromatography

## Application of Nexera UC SFE Pretreatment System for Extracting Pesticide Residues from Soil

Evaluating the persistence of pesticides in environmental soil is an important criteria for evaluating the safety of pesticides and analyzing pesticides in soil is extremely important for initial evaluations or registration of pesticides. However, in most cases, analyzing pesticides in soil using liquid-liquid extraction to extract the pesticides is very time-consuming, requires special equipment and reagents, and can cause problems, such as metal ions or other introduced ionic substances contaminating analytical instruments or the target substances being decomposed by oxidation, exothermic reactions, or other consequences of the extraction process.

In contrast, supercritical fluid extraction (SFE) provides excellent extraction efficiency using supercritical carbon dioxide as the extraction solvent, which offers the low viscosity and high diffusivity of a gas and the high solubility of a fluid. Consequently, it extracts target substances quickly using smaller quantities of organic solvent than existing solvent extraction methods, making it a more environmentally-friendly method as well.

This article describes an example of using the Nexera UC SFE pretreatment system to extract residual pesticides from soil.

### Off-Line SFE System

The operating principle of the Nexera UC SFE pretreatment system is shown in Fig. 1. An extraction vessel filled with a sample is placed in the SFE unit and heated to 40 °C (Fig. 1 A). The extraction vessel is then filled with supercritical carbon dioxide and the target components are extracted statically without pumping the liquid (Fig. 1 B). After static extraction, the target components are extracted dynamically by pumping supercritical carbon dioxide through the extraction vessel (Fig. 1 C). After trapping the extract material in the trap column, the eluate that contains the target components is then collected in the fraction collector (Fig. 1 D).

### Sample Preparation

Liquid-liquid extraction is typically used to pretreat soil samples for residual pesticide analysis. However, due to the extraction time and equipment required, throughput is low, limiting the number of samples that can be processed in a day. It also requires using organic solvent during extraction. Therefore, an alternative extraction method to liquid-liquid extraction is desirable, in terms of both the environment and cost.

In contrast, the Nexera UC SFE pretreatment system requires only mixing 1 g of soil with 1 g of a dehydrating agent\* and placing the mixture in the extraction vessel,

as shown in Fig. 2. This not only improves productivity and minimizes environmental impact, but also avoids human errors involved in the sample pretreatment process. Furthermore, a specially designed rack changer can be used to perform extraction consecutively for up to 48 samples.

\* "Miyazaki Hydro-Protect" Patent No. 364552

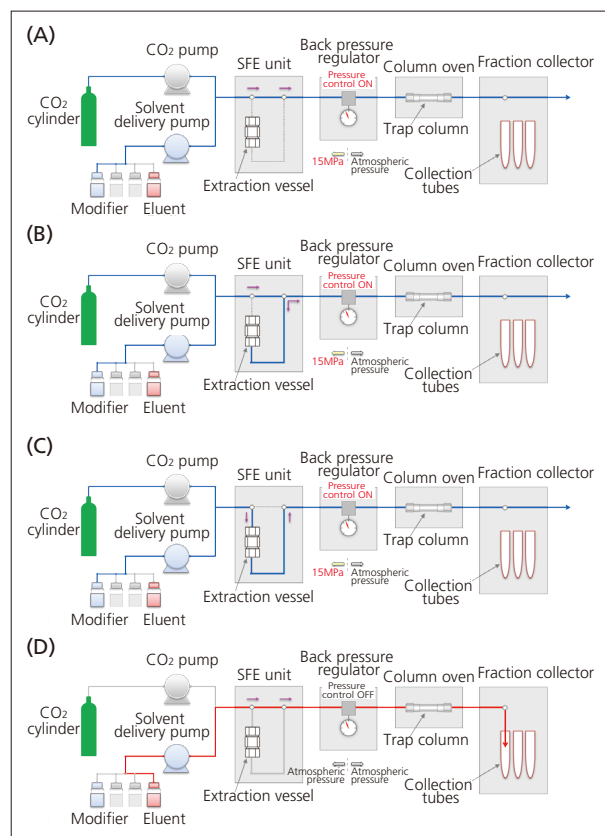


Fig. 1 Process Flow of SFE Extraction

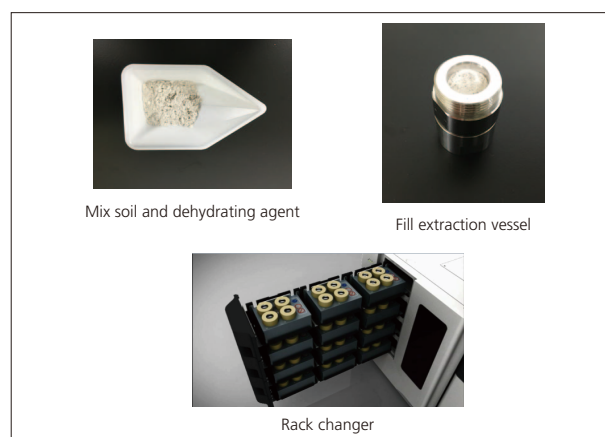


Fig. 2 Sample Preparation

### Extraction and Analysis of Residual Pesticides in Soil

Soil was spiked with 200 ng/g each of eight pesticide components, which were then extracted by SFE using the conditions indicated in Table 1. Eluent was added to the extract obtained to make 2 mL, which was then analyzed by LC-MS/MS using the conditions indicated in Table 1. Repeatability and recovery rate values for the eight pesticide components are shown in Table 2. Recovery rates were determined by comparing the area of pesticide peaks measured from the extract obtained from the soil spiked with pesticide and measured from the extract obtained from unspiked soil to which the pesticides were added after extraction. This system uses a simpler and faster pretreatment process than liquid-liquid extraction, which enables it to finish extraction in about 30 minutes per sample. It also uses less organic solvent, so it is superior in terms of the environment and cost as well.

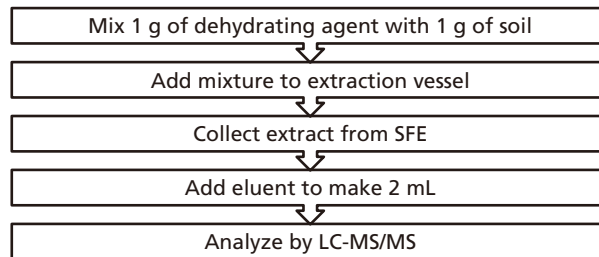


Fig. 3 Process Flow from Pretreatment to Analysis

Table 1 Extraction and Analytical Conditions

|  |   |
|--|---|
| [SFE] Nexera UC SFE System   | [LC] Nexera X2 System   |
| Solvent : A) Supercritical fluid of CO <sub>2</sub><br>B) Methanol | Column : Shim-pack UC-RP (150 mm L. × 2.1 mm I.D., 3 μm)                          |
| Flowrate : 5 mL/min  | Mobile Phase : A) 10 mM Ammonium formate<br>B) 10 mM Ammonium formate in methanol |
| Extraction : 4 min (Static mode → Dynamic mode)                    | Time Program : B. Conc. 0 % (0 min) → 100 % (14-17 min) →<br>0 % (17.1-20 min)    |
| Extraction : 40 °C   | Flowrate : 0.4 mL/min   |
| Vessel Temp.   | Column Temp. : 40 °C  |
| BPR Pressure : 15 MPa  | Injection Volume : 3 μL   |
| Trap Column : Shim-pack VP-ODS (50 mm L. × 4.6 mm I.D., 5 μm)      | [MS] LCMS-8060 (MRM mode)   |
| Column : 40 °C   | Ionization : ESI (positive or negative)   |
| Oven Temp.   | DL Temp. : 200 °C   |
| Elution Solvent : Acetone/Hexane = 50/50 (2 mL/min, 2 min)         | Block Heater Temp. : 400 °C   |
|  | Interface Temp. : 300 °C  |
|  | Nebulizing Gas Flow : 2 L/min   |
|  | Drying Gas Flow : 10 L/min  |
|  | Heating Gas Flow : 10 L/min   |

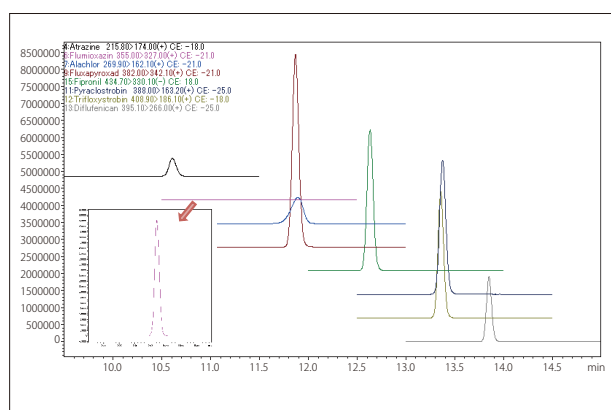


Fig. 4 MRM Chromatogram of Extract from Soil Spiked with Pesticides

Table 2 Repeatability and Recovery

| Compounds       | Repeatability (%RSD, n=6) | Recovery (%) |
|-----------------|---------------------------|--------------|
| Alachlor        | 1.9                       | 87.0         |
| Atrazine        | 1.3                       | 75.8         |
| Diflufenican    | 1.2                       | 86.2         |
| Fipronil        | 1.5                       | 80.6         |
| Flumioxazin     | 3.8                       | 70.1         |
| Fluxapyroxad    | 2.2                       | 72.9         |
| Pyraclostrobin  | 1.8                       | 73.3         |
| Trifloxystrobin | 1.5                       | 87.7         |

# Application News

## No. J109

### Inductively Coupled Plasma Atomic Emission Spectrometry

## Content Analysis of Toxic Elements in Soil by ICPE-9800 Series

### ■ Introduction

Contaminated soil not only leads to contamination of untreated drinking water through permeation into river water and rainwater, it adversely affects health when the soil itself is directly ingested as a child puts the ground into a stoma into a play etc. Therefore, assessment of soil toxicity using a defined method is required. In Japan, the Soil Contamination Countermeasures Law specifies content standards and related inspection methods (measurement method according to soil content investigation). Table 1 shows the established standard values for soil content. The testing method consists of elution tests based on the assumption that when soil is ingested, harmful elements contained in the soil will be absorbed in the body. The apparatus used for the analysis is required to accurately measure those elements at trace concentrations equivalent to or lower than the reference values.

Here, using the Shimadzu ICPE-9800 series multi-type ICP atomic emission spectrometer, we conducted content analysis of soil. The ICPE-9800 series, with its mini-torch plasma and spectrometer capable of simultaneous analysis of all elements at all wavelengths, can be used to conduct high-throughput, low-cost analysis with high sensitivity and high precision.

**Table 1 Soil Concentration Standard Values (Unit: mg/kg)**

| Element                           | As  | B    | Cd  | Cr <sup>6+</sup> | Hg | Pb  | Se  |
|-----------------------------------|-----|------|-----|------------------|----|-----|-----|
| Soil Concentration Standard Value | 150 | 4000 | 150 | 250              | 15 | 150 | 150 |

### ■ Sample

For analysis, we used a sample consisting of a standard substance with certified content (1 mol/L hydrochloric acid content survey method), as specified in the Ministry of the Environment Notification No. 19.

- Soil certified reference material (brown forest soil) JSAC0402, 0403 (The Japan Society for Analytical Chemistry)

### ■ Sample Preparation

Sample preparation was conducted according to the Test Solution Preparation Method of Soil Content Survey (Ministry of the Environment Notification No. 19), in conjunction with the total digestion method using a microwave sample preparation system.

#### - Test Solution Preparation Method for Soil Content Survey (Ministry of the Environment Notification No. 19, March 6, 2003)

Elution was performed using 200 mL of 1 mol/L hydrochloric acid per 6 g of soil sample, and Yb (Ytterbium) and In (Indium) were added as internal standard elements to the obtained eluate, which was

then filtered through a 0.45 μm membrane filter. The obtained filtrate was used as the analytical sample.

#### - Total content digestion method (Digestion using microwave sample preparation system)

Nitric acid and hydrofluoric acid were added to 0.2 g of sample, and digestion was conducted using a microwave sample preparation system. After transferring the digest solution to a fluorine resin beaker, the mixture was heated to near dryness (about 200 °C) on a hot plate. Dilute nitric acid and dilute hydrochloric acid were added to dissolve the contents. Yb and In were added as internal standard elements, and the volume was adjusted to 20 mL using distilled water. This solution served as the analytical sample.

### ■ Instrument and Analytical Conditions

Measurement was conducted using the Shimadzu ICPE-9800 series ICP atomic emission spectrometer. The analytical conditions are shown in Table 2.

The ICPE-9800 series, with a newly designed CCD which permits simultaneous measurement of all elements at all wavelengths, is built for high-throughput measurement, even when there are large numbers of samples and target elements. Further, the mini torch which suppresses the plasma gas flowrate, the Eco mode which suppresses gas and power consumption during wait periods, and use of a vacuum spectrometer which does not require purge gas, all serve to greatly reduce running costs as compared with conventional ICP instruments.

**Table 2 Analytical Conditions**

|                        |   |
|------------------------|---|
| Instrument             | : ICPE-9800 series                      |
| Radio frequency power  | : 1.2 kW                                |
| Plasma gas Flowrate    | : 10 L/min                              |
| Auxiliary gas Flowrate | : 0.6 L/min                             |
| Carrier gas Flowrate   | : 0.7 L/min                             |
| Sample introduction    | : Nebulizer 10                          |
| Misting chamber        | : Cyclone chamber                       |
| Plasma torch           | : Mini Torch                            |
| Observation            | : Axial (AX)                            |
| Measurement time       | : 2.5 min/sample (Including rinse time) |

### ■ Analysis

Here, using the internal standard method – calibration curve method, we conducted quantitative analysis of a standard containing seven elements. As internal standard elements, we used Yb and In, which are few concentration in soil.

### Analytical Results

Soil samples contain high concentrations of co-existing elements, such as Fe, Al, and Si, etc., and therefore may be the source of spectral interference with respect to trace elements in the matrix. For example, as can be seen in Fig. 1, the spectrum of Fe interferes with that of Cd at 214.438 nm. Correction between elements in which this type of interference (overlapping) occurs refers to the software feature which permits subtraction of the coexisting element spectrum. Table 3 shows the effectiveness of interference element correction (IEC), whereby the accuracy is significantly improved. The results of the soil content analysis are shown in Table 4. The lower limit of determination is now less than 1/10 that of the reference values for all elements. Good results matching the certified value were also obtained for elements in the low-concentration region below the reference value.

**Table 3 Effectiveness of interference element correction (IEC) for Cd at 214.438 nm**

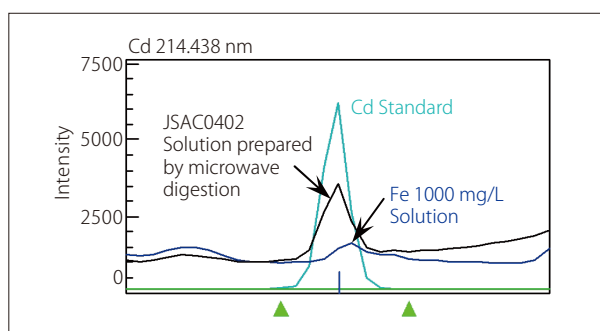
| JSAC0402<br>(Total content digestion method) | Cd<br>(mg/kg) | Co-Existing Element<br>(Fe) (%) |
|--|---------------|---------------------------------|
| Certified value                              | 18.5 ± 1.1    | 4.2 (Reference value)           |
| Quantitation value (with IEC)                | 18.4          |                                 |
| Quantitation value (without IEC)             | 19.9          |                                 |

### Conclusion

The ICPE-9800 series permits quick and accurate measurement of trace elements in the soil, at lower cost.

### [References]

- 1) Soil Contamination Countermeasures Law Enforcement Regulations (Ministry of the Environment Ordinance No. 29, December 26, 2002)
- 2) Determination of Measurement Methods According to Soil Content Investigation (Ministry of the Environment Notification No. 19, March 6, 2003)
- 3) JIS K0102-2013 (Testing Method for Industrial Wastewater)
- 4) US EPA SW-846 Method 3052 (Microwave Assisted Acid Digestion of Siliceous and Organically Based Matrices)



**Fig. 1 Spectral Interference of Cd 214.438 nm**

**Table 4 Results of Soil Content Analysis (Unit: mg/kg)**

| Pretreatment     |                        | Public Method (Ministry of the Environment Ordinance No. 19) |                    |                 |                    | Total Content Digestion Method |                    |                 |                    |                 |
|------------------|------------------------|--|--------------------|-----------------|--------------------|--------------------------------|--------------------|-----------------|--------------------|-----------------|
| Sample Name      |                        | Detection Limit  | JSAC0402           |                 | JSAC0403           |                                | JSAC0402           |                 | JSAC0403           |                 |
| Element          | Concentration Standard |  | Quantitation Value | Certified Value | Quantitation Value | Certified Value                | Quantitation Value | Certified Value | Quantitation Value | Certified Value |
| As               | 150                    | 0.2  | 11                 | 10.3 ± 0.9      | 115                | 111 ± 7                        | 42                 | 41.6 ± 3.2      | 195                | 199 ± 15        |
| B                | 4000                   | 0.02   | 15.8               | 15.6 ± 0.9      | 157.7              | 157 ± 3                        |                    | 115 ± 15        |                    | 269 ± 46        |
| Cd               | 150                    | 0.007  | 17.1               | 17.3 ± 0.4      | 178.2              | 178 ± 5                        | 18.4               | 18.5 ± 1.1      | 182.2              | 183 ± 7         |
| Cr <sup>6+</sup> | 250                    | 0.02   | 7.4                |                 | 64.8               |                                | 91                 | 90.5 ± 6.9      | 250.4              | 257 ± 9         |
| Hg               | 15                     | 0.1  | 0.6                | 0.6 ± 0.1       | 6.7                | 7 ± 1                          |                    | 1.3 ± 0.1       |                    | 11.1 ± 1        |
| Pb               | 150                    | 0.1  | 32                 | 32.3 ± 0.8      | 193                | 197 ± 4                        | 44                 | 45.2 ± 7.1      | 216                | 224 ± 13        |
| Se               | 150                    | 0.2  | 3                  | 2.7 ± 0.6       | 64                 | 63.5 ± 6.4                     | 18                 | 17 ± 1.7        | 163                | 169 ± 13        |

Content reference value : Soil content reference value according to the Soil Contamination Countermeasures Law  
 Detection limit : 3 times the concentration of the standard deviation obtained from 10 measurements of a calibration curve blank × Dilution factor (200/6)  
 Cr<sup>6+</sup> : The content standard is Cr<sup>6+</sup>, but the analytical value is the total Cr value.

# Application News

## No. G279

### Gas Chromatography

## Improvement of Sensitivity and Repeatability in Analysis of Formic Acid

- Artificial Photosynthesis Research and Impurity Analysis of Chemical Raw Material -

In the study of artificial photosynthesis and impurity analysis of raw materials and chemical products, high-sensitivity analysis of formic acid has become an important requirement. When conducting analysis of formic acid by gas chromatography (GC), detection is typically conducted using either a thermal conductivity detector (TCD) or a combination of methanizer + FID detector. As the TCD is appropriate for relatively low-sensitivity detection, it is mainly used for analysis of high-concentration samples, while the methanizer + FID combination is used in analysis of low-concentration samples. Because the FID alone exhibits little or no response to formic acid as is, it must first be reduced to methane using a methanizer, which then permits detection by FID.

A methanizer can be a useful tool, but it does have its disadvantages under certain conditions, including deactivation of the catalyst if the oxygen concentration in the sample is greater than 100 ppm, or if the sample environment is high in carbon dioxide. Furthermore, if excessive water enters the system, it can take considerable time to restore the system. These disadvantages require the use of a valve system to eliminate oxygen or carbon dioxide. On the other hand, a barrier discharge ionization detector (BID) is a detector that is capable of detecting formic acid at ppm-order concentrations, thereby permitting high-sensitivity measurement, as long as coexisting components such as oxygen can be separated by the column.

In this Application News, we introduce an example of high-sensitivity analysis of formic acid included in various organic solvents using a GC-BID system.

### Validation of Phosphoric Acid Treatment

When conducting GC measurement of formic acid at low concentrations, care must be taken to prevent adsorption to the various component surfaces. To prevent adsorption at the injection port, phosphoric acid treatment of the glass insert is essential. Here, after immersing the wool-filled glass insert (Restek Sky Inlet Liner, P/N: 23319.1) in 0.3 % phosphoric acid / acetone solution for one minute, it was removed, dried and then used for the analysis. Fig. 1 shows the pretreatment procedure flow used for the glass insert, and Fig. 2 shows the effectiveness of this pretreatment in low-concentration analysis. When measurement of a 10-ppm (v/v) formic acid solution (solvent: acetone) was conducted using the analytical conditions shown in Table 1, peak detection was not achieved using an untreated glass insert, while detection with good sensitivity was achieved using a glass insert that had been pretreated with phosphoric acid. The following analyses were conducted using the analytical conditions shown in Table 1.

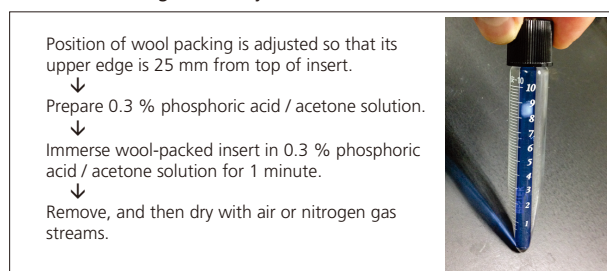


Fig. 1 Glass Insert Phosphoric Acid Treatment Procedure

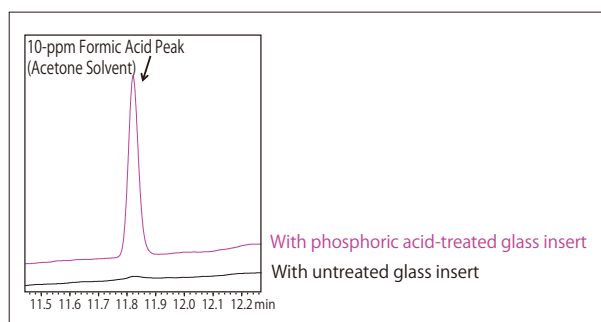


Fig. 2 Effectiveness of Glass Insert Phosphoric Acid Treatment in Low-Concentration Formic Acid Analysis

Table 1 Analytical Conditions

|               |  |
|---------------|--|
| Model         | : Tracera (GC-2010 Plus + BID 2010 Plus)                 |
| Inj. Mode     | : Split 1:2  |
| Inj. Temp     | : 240 °C   |
| Carrier Gas   | : He 50 cm/sec. (Constant Linear Velocity Mode)          |
| Column        | : RESTEK Rtx-WAX (60 m x 0.53 mm I.D., df = 1.0 μm)      |
| Column Temp.  | : 80 °C - 5 °C/min - 130 °C - 15 °C/min - 230 °C (3 min) |
| Det. Temp.    | : 240 °C   |
| Discharge Gas | : 50 mL/min (He)   |
| Glass Insert  | : RESTEK Sky Inlet Liner P/N 23319.1                     |
| Inj. Volume   | : 1 μL   |

The Rtx-WAX column (Restek Co.) was used for the analysis. Peak tailing was evident when measurement of a 10-ppm (v/v) formic acid aqueous solution (Solvent: Acetone) was conducted using an unused column directly after aging treatment. We then applied the same phosphoric acid treatment that was used for the glass insert to the column as well. The column phosphoric acid treatment procedure is shown in Fig. 3. A 100-ppm (v/v) phosphoric acid / methanol solution was measured four times, and this was followed by ten repeat measurements methanol alone using a constant column temperature of 150 °C (the other conditions were the same as those shown in Table 1). Then, we conducted repeat measurements of 10-ppm (v/v) formic acid solution (Solvent: Acetone), and we checked the stability of the peak shape and retention time. A comparison of the peak shapes of formic acid before and after the column phosphoric acid treatment is shown in Fig. 4. The comparative results confirmed that the peak shape was sharper following phosphoric acid treatment of the column.

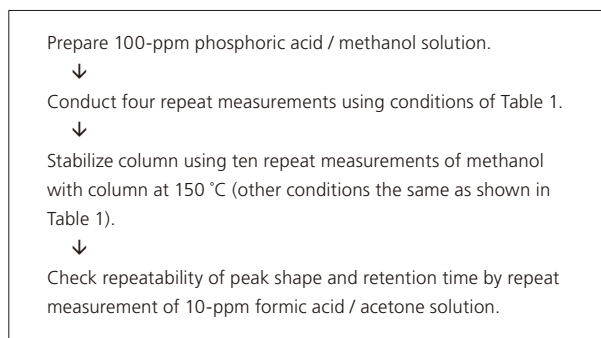
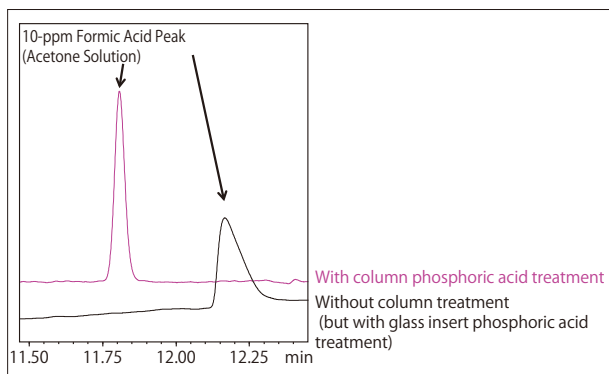


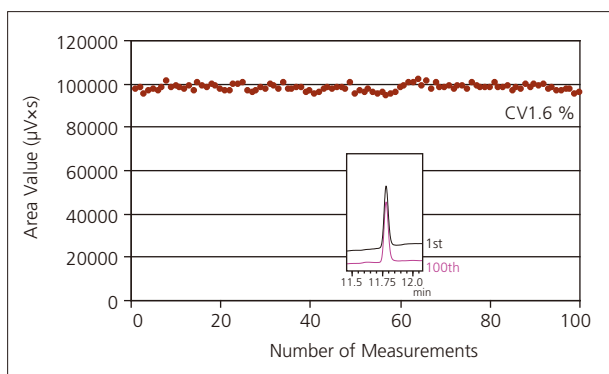
Fig. 3 Procedure for Column Phosphoric Acid Treatment



**Fig. 4 Comparison of Formic Acid Peak Shapes Before and After Column Phosphoric Acid Treatment**

To check the stability obtained with the glass insert and column phosphoric acid treatment, 100 repeat measurements of a 10-ppm (v/v) formic acid solution (Solvent: Acetone) were conducted. The area repeatability obtained was CV 1.6 %, and considering that the septum replacement guideline is based on 100 analyses, this confirms the effectiveness of the phosphoric acid treatment (Fig. 5).

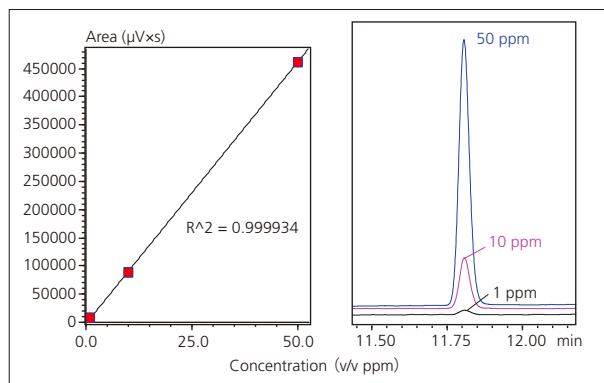
Although the Rtx-WAX column was used in this study, we have not yet evaluated whether or not the same results would be obtained with other WAX columns. Further, since a column subjected to the same phosphoric acid treatment may have an adverse effect when used to conduct a different analysis, it is advisable to use the column specifically for formic acid analysis.



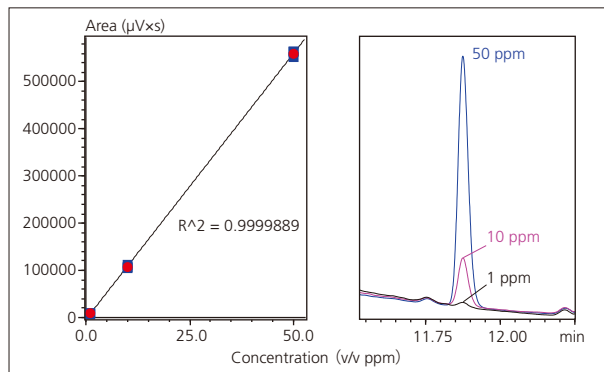
**Fig. 5 Repeatability of Peak Area with 10-ppm Formic Acid / Acetone Solution at the Hundredth Analysis**

### ■ Analysis of Low-Concentration Formic Acid in Various Organic Solvents

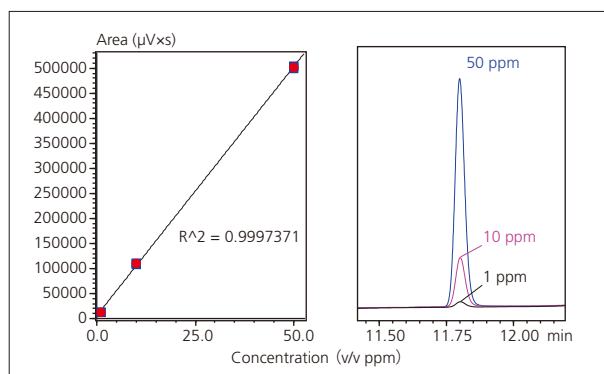
We checked the linearity of results using various concentrations of formic acid (1, 10, 50 ppm (v/v)) in different solvents, including acetone, *N,N*-dimethylacetamide, acetonitrile, and methanol. The linearity and chromatograms obtained in analysis of the acetone, *N,N*-dimethylacetamide, acetonitrile, and methanol solvent samples are shown in Figs. 6 to 9, respectively.



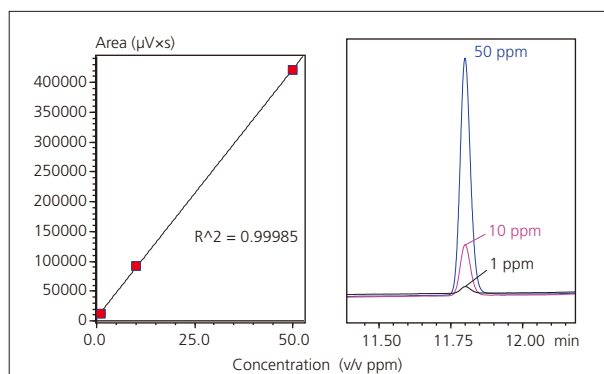
**Fig. 6 Linearity of Formic Acid in Acetone (1, 10, 50 ppm)**



**Fig. 7 Linearity of Formic Acid in *N,N*-Dimethylacetamide (1, 10, 50 ppm)**



**Fig. 8 Linearity of Formic Acid in Acetonitrile (1, 10, 50 ppm)**



**Fig. 9 Linearity of Formic Acid in Methanol (1, 10, 50 ppm)**



# Application News

## No. G280A

### Gas Chromatography

## High-Sensitivity Analysis of Formic Acid Using GC-BID in Artificial Photosynthesis Research

Artificial photosynthesis refers to a technique of creating high-energy materials using photocatalysis and solar energy, and is expected to play a role in the development of next-generation renewable energy. In the photochemical carbon dioxide reduction reaction, which is currently a research theme, there are instances in which formic acid is the main reaction product. Analysis of formic acid is typically conducted by liquid chromatography, ion chromatography or capillary electrophoresis, etc. However, since analysis of the formic acid dissolved in the organic solvent requires at least a ten-fold dilution of the solvent using water or mobile phase, such a low-concentration analysis can sometimes be difficult. On the other hand, since a gas chromatograph (GC) can directly measure organic solvents as is without dilution, use of the BID-2010 Plus for high-sensitivity detection of formic acid permits analysis at the ppm level.

This Application News introduces an example in which the GC-BID is used for analysis of formic acid in an actual sample consisting of the solvent *N,N*-dimethylacetamide, used in the research of artificial photosynthesis. Also, regarding analysis of formic acid at low concentrations, additional cautionary notes can be found in Application News G279.

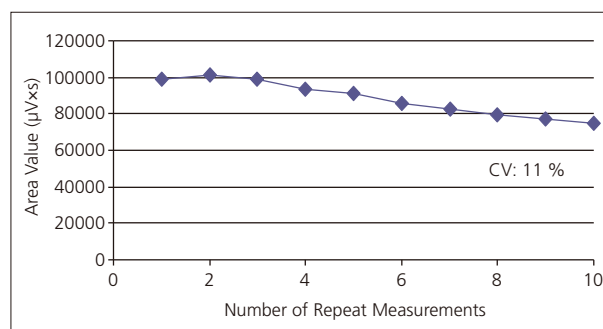
### ■ Analysis of Actual Sample Obtained from Artificial Photosynthesis Reaction

The sample solution consisted of the solvent *N,N*-dimethylacetamide as the carbon dioxide reduction reagent, in which 0.1 M tetraethylammonium tetrafluoroborate ( $\text{NEt}_4\text{BF}_4$ ) was dissolved<sup>1)</sup>. The analytical conditions used are shown in Table 1. The sample solution was spiked with formic acid at 10 ppm (v/v), and ten repeat measurements were then conducted. The formic acid peak areas showed a gradual decline, as can be seen in Fig. 1.

1) This sample was provided by Professor Osamu Ishitani of the University of Tokyo Institute of Technology Graduate School of Science and Engineering.

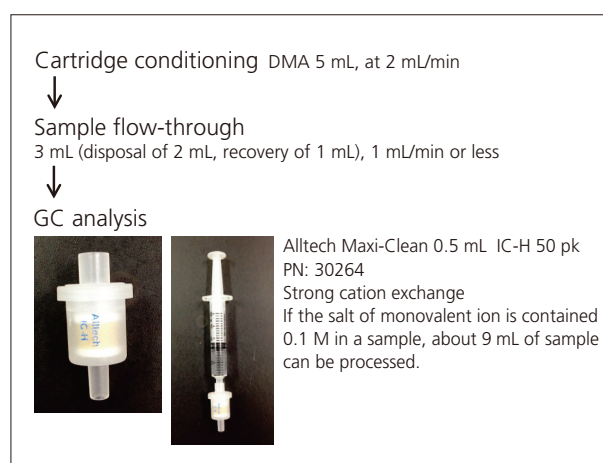
**Table 1 Analytical Conditions**

|               |  |
|---------------|--|
| Model         | : TracerA (GC-2010 Plus + BID 2010 Plus)                 |
| Inj. Mode     | : Split 1 : 2  |
| Inj. Temp     | : 240 °C   |
| Carrier Gas   | : He 50 cm/sec. (Constant Linear Velocity Mode)          |
| Column        | : RESTEK Rtx-WAX (60 m × 0.53 mm I.D., df=1.0 μm)        |
| Column Temp.  | : 80 °C - 5 °C/min - 130 °C - 15 °C/min - 230 °C (3 min) |
| Det. Temp.    | : 240 °C   |
| Discharge Gas | : 50 mL/min (He)   |
| Glass Insert  | : RESTEK Sky Inlet Liner P/N 23319.1                     |
| Inj. Volume   | : 1 μL   |



**Fig. 1 Changes in Formic Acid Peak Area Before Pretreatment**

Since it was presumed that the adsorption of formic acid in the GC injection unit was due to accumulation of the electrolyte  $\text{NEt}_4\text{BF}_4$  which coexists with the sample in the injection unit, the  $\text{NEt}_4\text{BF}_4$  was removed prior to GC measurement using a cation exchange cartridge (Alltech Maxi-Clean 0.5 mL IC-H 50 pk, P/N 30264). The  $\text{NEt}_4\text{BF}_4$  removal procedure is shown in Fig. 2. We then conducted ten repeat measurements of the sample after eliminating the  $\text{NEt}_4\text{BF}_4$ , and verified results with good repeatability (Fig. 3). It is believed that the influence of salt was removed by replacing the cation ( $\text{Net}_4^+$ ) with  $\text{H}^+$  using a cation exchange cartridge.



**Fig. 2 Pretreatment Procedure Using Cation-Exchange Cartridge**

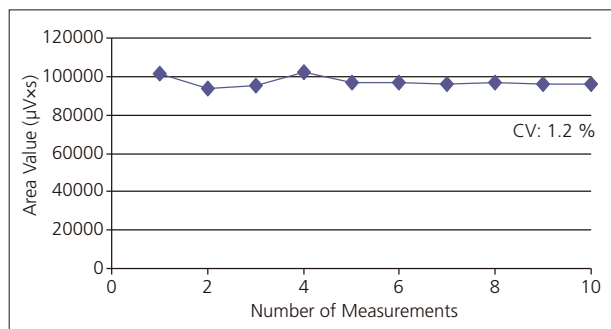


Fig. 3 Changes in Formic Acid Peak Area After Pretreatment

To verify the rate of recovery, sample solutions spiked with formic acid at 1, 10 and 50 ppm (v/v), respectively, were subjected to pretreatment according to the procedure of Fig. 2, and then measured by GC. The results are shown in Table 2. The rates of recovery were nearly 100 %. Further, to check the repeatability of the pretreatment procedure, a sample solution spiked with 10 ppm (v/v) formic acid was subjected to pretreatment and measurement five times, once each per sample. The chromatogram is shown in Fig. 4, and the formic acid peak area repeatability values are shown in Table 3.

Table 2 Results of Recovery Test

|                  | Quantitation Value ppm (n=3 mean) |
|------------------|-----------------------------------|
| Spiked at 1 ppm  | 0.97                              |
| Spiked at 10 ppm | 9.5                               |
| Spiked at 50 ppm | 50                                |

Table 3 Results of Pretreatment Repeatability Test

|                       | First | Second | Third | Fourth | Fifth | Mean    | SD      | RSD% |
|-----------------------|-------|--------|-------|--------|-------|---------|---------|------|
| Formic acid peak area | 97159 | 94176  | 91712 | 92819  | 91562 | 93485.6 | 2305.47 | 2.47 |

The pretreatment procedure shown in Fig. 2 that was used for the samples in this investigation was effective, but in cases where the samples contain salt at higher concentrations, it might not be sufficiently effective, requiring repeat processing of the cartridge. If the salt, solvent type or concentration varies depending on the sample, verification must be conducted for each sample separately. In addition, please note that if treatment is conducted on samples containing sulfate or hydrochloride using a cation exchange cartridge, corrosion of the column, etc. may occur due to the strong acidity that may develop.

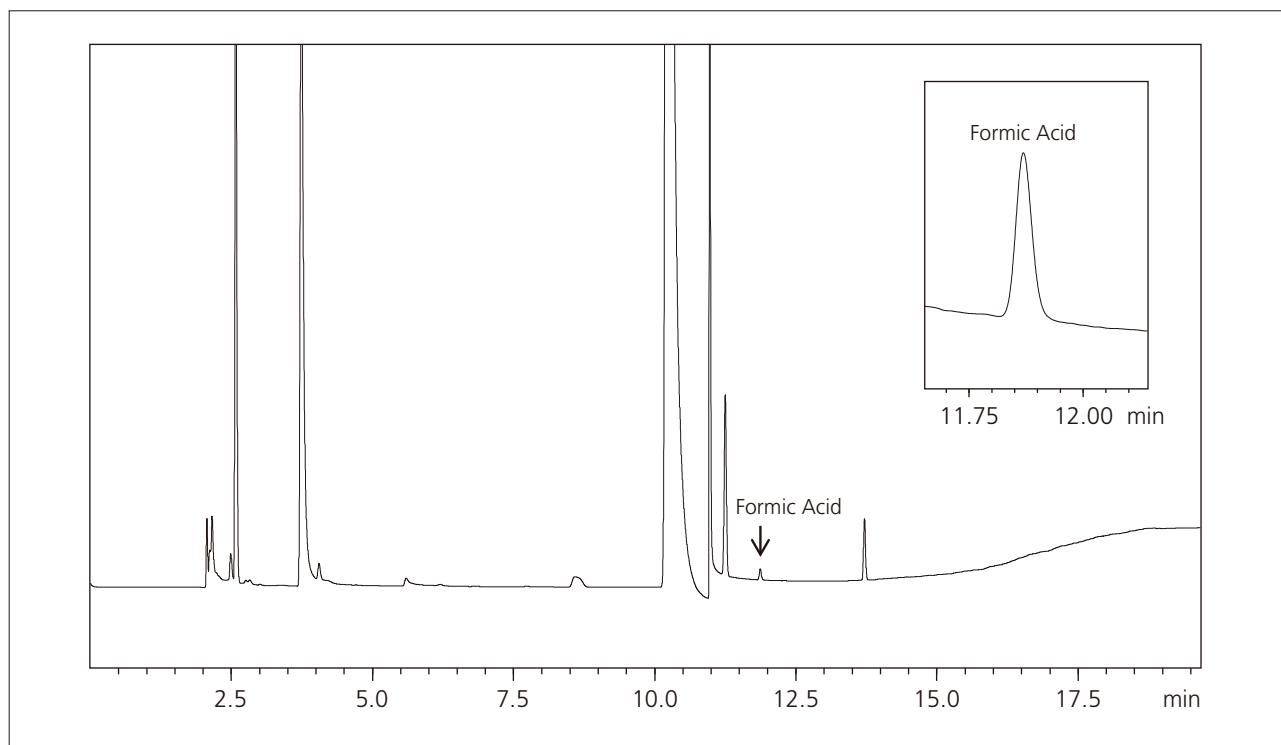


Fig. 4 Chromatogram from Analysis of 10 ppm Pretreated Formic Acid in Actual Sample Solution

# Application News

## No. G281

### Gas Chromatography

## High-Sensitivity Analysis of Ammonia, Methylamine, and Trimethylamine in Environmental and Energy Fields

Nitrogen compounds such as ammonia and various amines are known as malodorous substances, and besides concern associated with the offensive odors, they have potential adverse effects on human life. On the other hand, ammonia's high energy density per unit volume and the ease with which it can be stored and transported has resulted in increased research in its use as a medium for the storage of hydrogen in fuel cells. The increased use of ammonia and the close proximity of associated amines to humans accentuate the necessity for methods of accurate and rapid detection and quantitation of these substances. The flame thermionic detector (FTD) is known as a high-sensitivity detector for nitrogen compounds, but because the FTD does not respond to ammonia, it cannot be used for its detection. Typically, ammonia analysis by gas chromatography (GC) is conducted using a thermal conductivity detector (TCD), but measurement is difficult using TCD unless the concentration is greater than about 100 ppm.

The dielectric barrier discharge ionization detector (DIBID) permits detection of nearly all compounds, except for helium and neon, at higher sensitivity than that possible with TCD and FID detectors. Here, we introduce examples of analysis at the ppm level of ammonia and methylamine in water, and of trimethylamine in water by GC-BID.

### ■ Analysis of Ammonia and Methylamine

Ammonia and methylamine were diluted with water to prepare solutions at 4.8 ppm, 24 ppm and 120 ppm, respectively, and the solutions were then measured by GC-BID.

The 4.8 ppm and 24 ppm chromatograms are shown in Fig. 1, the linearity is shown in Fig. 2, and the analytical conditions are shown in Table 1. Calculating the lower limit of detection ( $S/N = 3$ ) from the 4.8 ppm  $S/N$  ratio, the results indicated 1.2 ppm for ammonia and 2.5 ppm for methylamine.

Linearity may be sacrificed at low concentrations of components that display adsorption. In this analysis, good linearity was obtained over the range including 4.8 ppm, 24 ppm, and 120 ppm. It should be noted that in this analysis, base-deactivated wool (RESTEK P/N: 20999) was used to pack the glass insert to prevent adhesion of ammonia and the amines at the injection port.

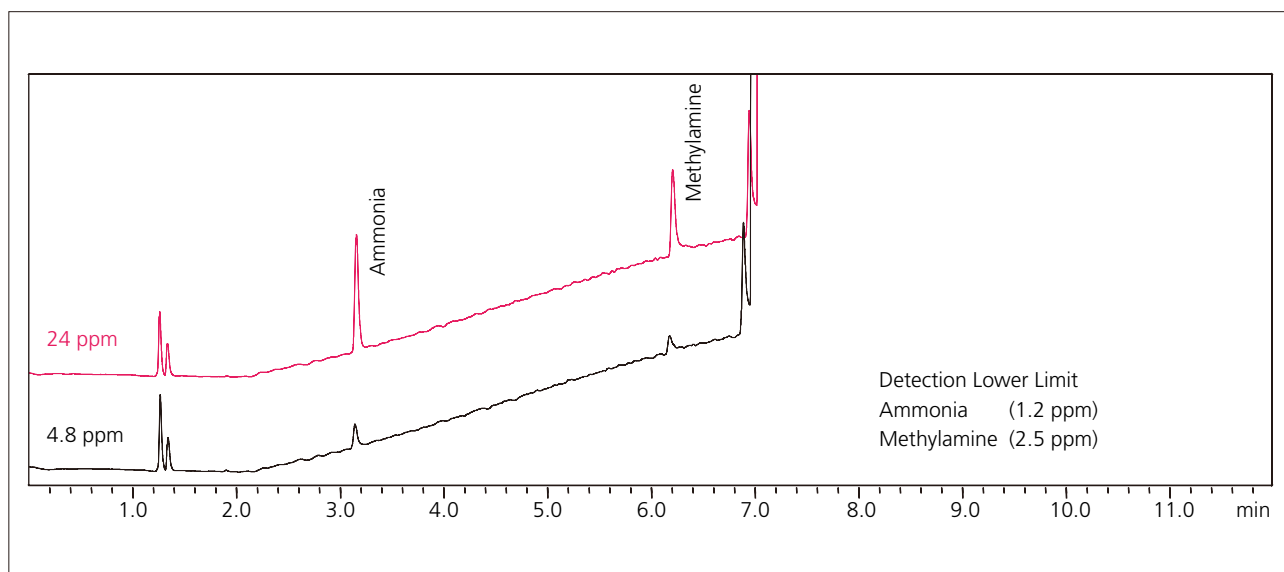
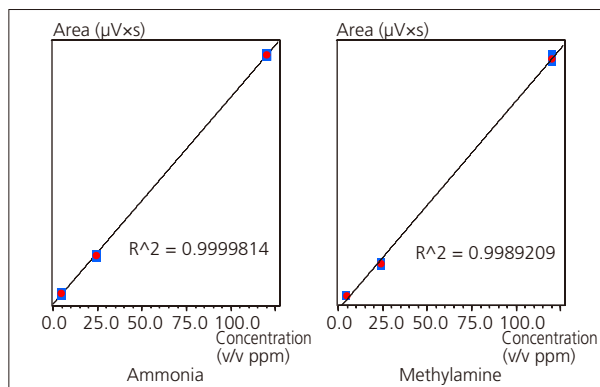


Fig. 1 Chromatograms of 4.8 ppm and 24 ppm Standard Solutions

**Table 1 Analytical Conditions for Ammonia and Methylamine**

|               |   |
|---------------|---|
| Model         | : Tracera (GC-2010 Plus + BID-2010 Plus)                            |
| Inj. Mode     | : Split 1:5   |
| Inj. Temp.    | : 220 °C  |
| Carrier Gas   | : He 50 cm/sec. (Constant Linear Velocity Mode)                     |
| Column        | : PoraPLOT Amines (25 m × 0.53 mm I.D., df = 20 μm)                 |
| Column Temp.  | : 80 °C (2 min) - 10 °C/min - 130 °C - 20 °C/min - 200 °C (1.5 min) |
| Det. Temp.    | : 220 °C  |
| Discharge Gas | : 50 mL/min (He)  |
| Glass Insert  | : Split insert  |
|               | : Restek Base Deacts FS wool  |
| Inj. Volume   | : 1.0 μL  |



**Fig. 2 Linearity of Ammonia and Methylamine (4.8, 24, 120 ppm)**

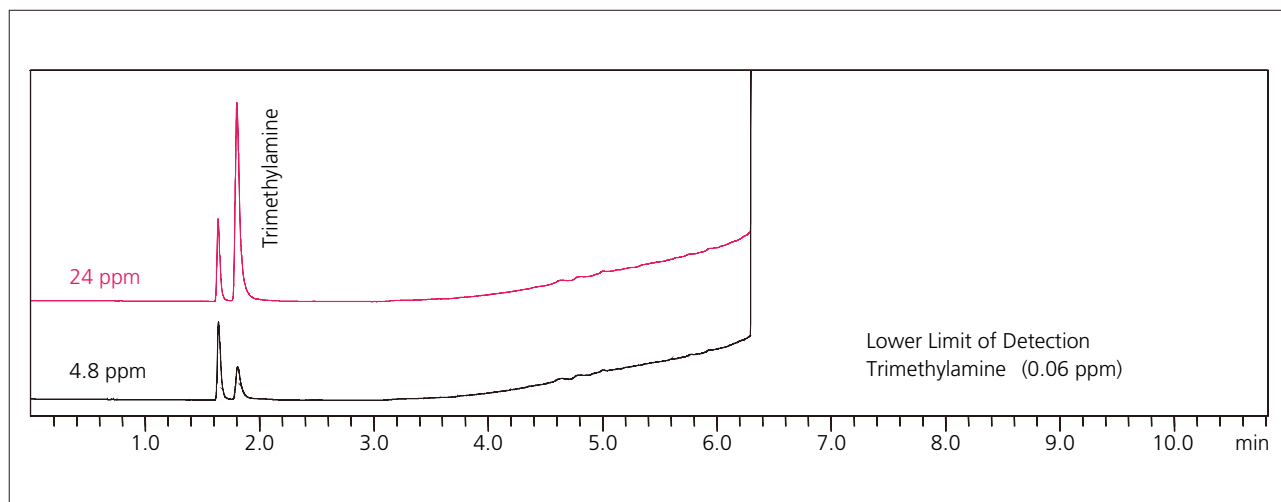
**■ Analysis of Trimethylamine**

Since the above analytical conditions do not permit separation of the trimethylamine and water peaks, analysis was conducted using a different column. (Using these analytical conditions, ammonia and methylamine cannot be separated.)

The trimethylamine was diluted with water to obtain concentrations of 4.8 ppm, 24 ppm, and 120 ppm, respectively. These solutions were analyzed by GC-BID. The chromatograms obtained with the 4.8 ppm and

24 ppm solutions are shown in Fig. 3, the linearity is shown in Fig. 4, and the analytical conditions are shown in Table 2.

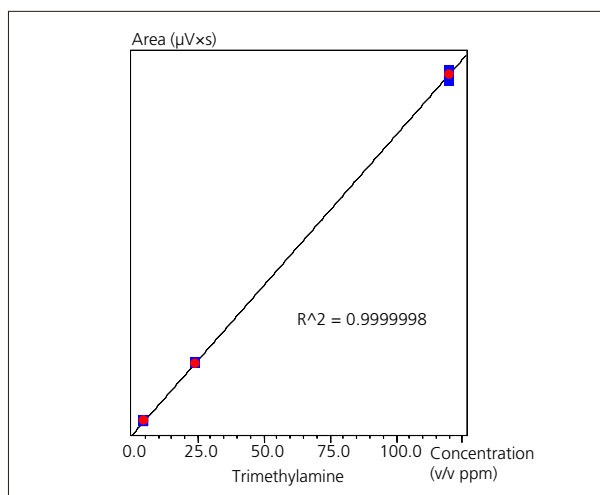
Calculating the lower limit of detection from the S/N using the 4.8 ppm solution, the result was 0.06 ppm. Further, excellent linearity was obtained over the range of concentrations including 4.8 ppm, 24 ppm and 120 ppm.



**Fig. 3 Chromatograms of 4.8 ppm and 24 ppm Standard Solutions**

**Table 2 Analytical Conditions for Trimethylamine**

|               |  |
|---------------|--|
| Model         | : Tracera (GC-2010 Plus + BID-2010 Plus)                 |
| Inj. Mode     | : Split 1:5  |
| Inj. Temp.    | : 220 °C   |
| Carrier Gas   | : He 40 cm/sec. (Constant Linear Velocity Mode)          |
| Column        | : RESTEK Stabilwax-DB (30 m × 0.53 mm I.D., df = 1.0 μm) |
| Column Temp.  | : 35 °C (3 min) - 30 °C/min - 180 °C (3.0 min)           |
| Det. Temp.    | : 220 °C   |
| Discharge Gas | : 50 mL/min (He)   |
| Glass Insert  | : Split insert   |
|               | : Restek Base Deacts FS wool                             |
| Inj. Volume   | : 1.0 μL   |



**Fig. 4 Linearity of Trimethylamine**

# Application News

## No. G291

### Gas Chromatograph

## Analysis of Thiophene in Benzene using Nexis GC-2030

Thiophene and other sulfur compounds are known to be linked to sulfur oxide generation during combustion, and as compounds associated with catalyst poisoning. Even very small quantities can have adverse effects, so the quality control of petroleum products requires trace analysis of sulfur compounds.

In the petroleum refinement process, thiophene is eluted together with benzene. ASTM D 7011 specifies standards for the analysis of thiophene impurities in benzene.

The FPD-2030 flame photometric detector, which is installed in Nexis GC-2030 gas chromatograph, has the world's highest level of sensitivity\*, thanks to the optimized nozzle shape and the advanced dual focus system. In the analysis of sulfur content in petroleum products, this detector provides high sensitivity and high stability.

In this Application News, we describe the analysis of thiophene in benzene using Nexis GC-2030 gas chromatograph equipped with the FPD-2030.

E. Kobayashi, T. Murata  
\* As of May 2017

### Instrument Used and Analytical Conditions

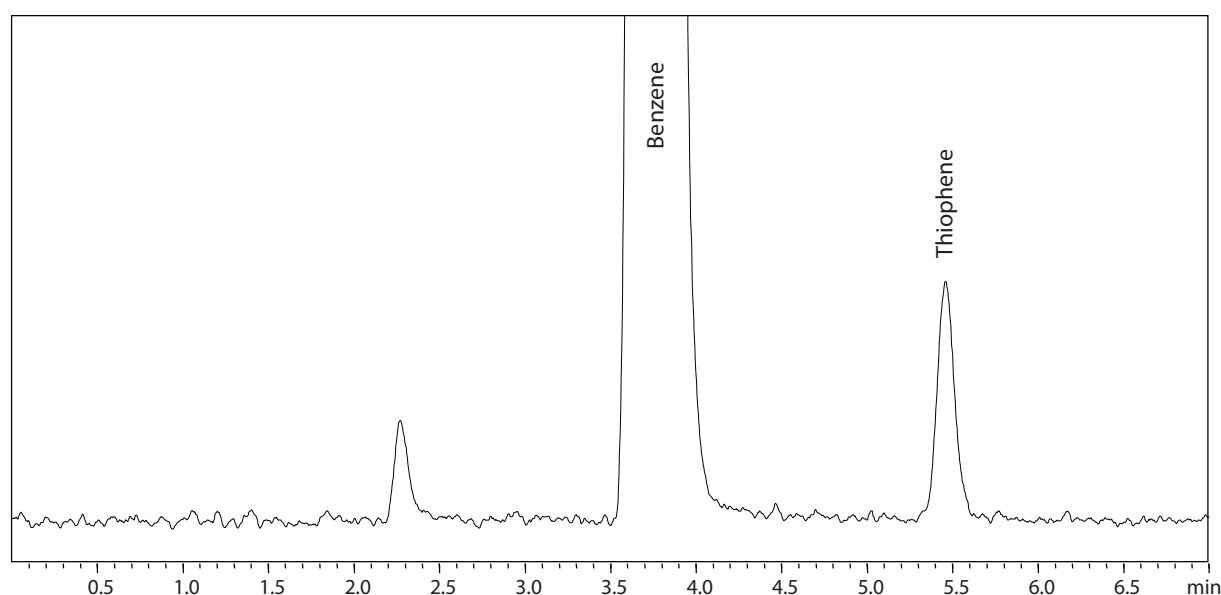
**Table 1 GC analytical condition**

|                       |  |
|-----------------------|--|
| Model                 | : Nexis GC-2030 / AOC-20i  |
| Software              | : LabSolutions LC/GC   |
| Injection Unit        | : WBI direct injection unit                                      |
| Injection Volume      | : 1 $\mu$ L  |
| Injection Temperature | : 200 °C   |
| Column                | : SH-Stabiliwax (0.53 mm I.D. $\times$ 30 m, d.f. = 2.0 $\mu$ m) |
| Column Temperature    | : 75 °C (7 min) Total 7 min                                      |
| Purge Gas             | : 3 mL/min (He)  |
| Carrier Gas           | : He (99.999%)   |
| Carrier Gas Control   | : Constant flowrate Total flowrate: 10 mL/min(He)                |
| Detector              | : FPD-2030 (S)   |
| Detector Temperature  | : 230 °C   |
| Detector Gas          | : H <sub>2</sub> : 40 mL/min, Air: 60 mL/min                     |

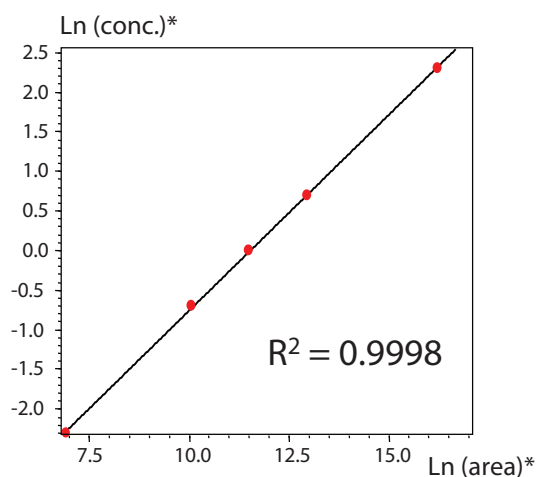
### Analysis Results

The results of analyzing 0.1 to 10 ppm of thiophene (in a benzene solution) via the capillary column GC-FPD method are shown below.

0.1 ppm of thiophene in benzene was detected (S/N=16), and favorable linearity was obtained in the range from 0.1 to 10 ppm. (Fig. 2)

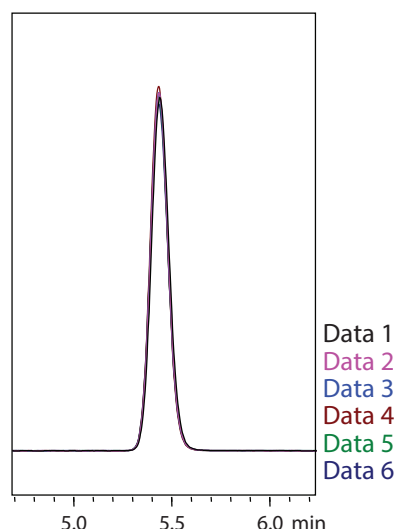


**Fig. 1 Chromatogram of 0.1 ppm Thiophene in Benzene**



\* In the analysis of sulfur compounds using an FPD detector, the output is proportional to the square of the sulfur concentration. Thus the natural logarithm for both concentration and area should be plotted.

**Fig. 2 Linearity of Thiophene in Benzene**



**Fig. 3 Chromatogram (Overlap of Six Consecutive Analyses) from the Repeated Analyses of 1 ppm Thiophene in Benzene**

**Table 2 Repeatability of Area Values ( $\mu\text{V} \times \text{sec}$ ) for 1 ppm**

|                  | 1     | 2     | 3     | 4     | 5     | 6     | Ave.  | RSD% |
|------------------|-------|-------|-------|-------|-------|-------|-------|------|
| <b>Thiophene</b> | 97646 | 98126 | 97901 | 99524 | 97693 | 96797 | 97948 | 0.91 |

Note: The above are reference values, not guaranteed values.

# Application News

## No. G298

### Gas Chromatography

## Examples of Analyzing Organic Compound Species with Hydrogen Carrier Gas Using Nexis GC-2030

Hydrogen is lower in cost than helium, which is often used as a carrier gas for gas chromatography. In addition, it is known to allow favorable separation at higher linear velocities compared to helium. On the other hand, it is a combustible gas and therefore requires great care in handling.

The new Nexis GC-2030 gas chromatograph can be equipped with a hydrogen sensor for detecting the hydrogen concentration within the column oven (Fig. 1). When the hydrogen concentration inside the oven exceeds 0.4 %, an error message is displayed, all temperature controls are stopped and the oven flap is fully opened. When the concentration reaches 2 %, the instrument is forcibly stopped to prevent an accident. This sensor allows safe use of hydrogen as a carrier gas.

This article introduces example analyses of a mixed solution containing typical organic compounds with hydrogen carrier gas using the new Nexis GC-2030 gas chromatograph.

Y. Nagao, T. Murata

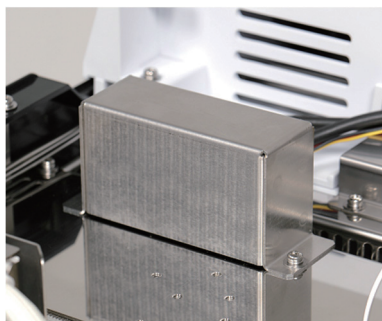


Fig. 1 Appearance of Hydrogen Sensor

### Example Analysis 1

A mixed solution of organic compounds was prepared by dissolving 10 organic compound species in ethanol to contain 1 vol% of each compound. Table 1 lists the analysis conditions. A hydrogen flame ionization detector (FID) requires a constant flow rate of hydrogen for the detector gas. However, when using hydrogen for the carrier gas, the total volume of detector gas and carrier gas is supplied to the FID. This means that when the carrier gas flow rate of the column changes, the condition of the FID also changes. To avoid this, we employed the constant column flow rate mode in this analysis. Fig. 2 shows the obtained chromatograms.

We can see that analysis using hydrogen for the carrier gas achieved a shorter analysis time than that with helium and the degree of separation is of the same level. When using hydrogen, the linear velocity of carrier gas at the initial column temperature was 54.1 cm/s and when using helium the value was 45.3 cm/s.

Table 1 GC Analysis Conditions

|                     |  |
|---------------------|--|
| Model               | : Nexis GC-2030, AOC-20i   |
| Injection Mode      | : Split mode   |
| Injection Volume    | : 0.5 $\mu$ L  |
| Split Ratio         | : 1:50   |
| Injection Temp.     | : 260 $^{\circ}$ C   |
| Carrier Gas         | : H <sub>2</sub> /He   |
| Carrier Gas Control | : Constant column flow rate (3 mL/min)   |
| Column              | : SH-StabiliWAX (30 m $\times$ 0.32 mm I.D., 0.50 $\mu$ m)   |
| Column Temp.        | : 50 $^{\circ}$ C (2 min) - 10 $^{\circ}$ C/min - 200 $^{\circ}$ C                                   |
| Detector            | : FID  |
| Detector Temp.      | : 260 $^{\circ}$ C   |
| Detector Gas        | : H <sub>2</sub> 32.0 mL/min, Air 200 mL/min   |
| Makeup Gas          | : With H <sub>2</sub> carrier gas: N <sub>2</sub> (24 mL/min)<br>With He carrier gas: He (24 mL/min) |

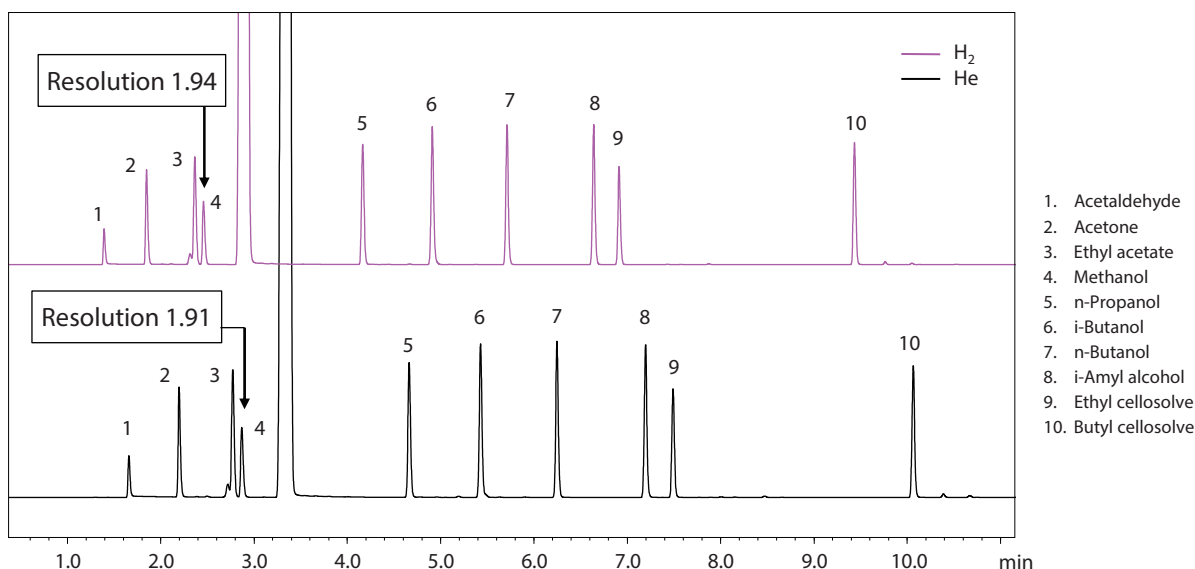


Fig. 2 Chromatograms of Mixed Solution of 10 Species (Pink: H<sub>2</sub> Carrier Gas, Black: He Carrier Gas)

1. Acetaldehyde
2. Acetone
3. Ethyl acetate
4. Methanol
5. n-Propanol
6. i-Butanol
7. n-Butanol
8. i-Amyl alcohol
9. Ethyl cellosolve
10. Butyl cellosolve

### Example Analysis 2

Narrow-bore columns with an inner diameter of 0.10 mm or 0.18 mm are known to produce higher theoretical plate numbers when compared to normal capillary columns because of their small inner diameter. On the other hand, narrow-bore columns have a large column resistance. This calls for an extremely high injection port pressure and at times may make pressure control difficult. Hydrogen has a lower viscosity compared to helium and nitrogen and a relatively lower injection port pressure is possible, enabling it to be used well together with narrow-bore columns which have a high theoretical plate number.

In this analysis, a narrow-bore column with an inner diameter of 0.10 mm and hydrogen carrier gas were used. Table 2 lists the detailed analysis conditions.

**Table 2 GC Analysis Conditions**

|                     |  |
|---------------------|--|
| Model               | : Nexis GC-2030, AOC-20i   |
| Injection Mode      | : Split mode   |
| Injection Volume    | : 0.5 $\mu$ L  |
| Split Ratio         | : 1:100  |
| Injection Temp.     | : 260 °C   |
| Carrier Gas         | : H <sub>2</sub> /He   |
| Carrier Gas Control | : Constant column flow rate (0.8 mL/min)   |
| Column              | : SH-Rtx-WAX (20 m $\times$ 0.10 mm I.D., 0.10 $\mu$ m)  |
| Column Temp.        | : 40 °C - 4 °C/min - 50 °C (1 min) - 40 °C/min - 90 °C (2 min*)                                      |
| Detector            | : FID  |
| Detector Temp.      | : 260 °C   |
| Detector Gas        | : H <sub>2</sub> 32.0 mL/min, Air 200 mL/min   |
| Makeup Gas          | : With H <sub>2</sub> carrier gas: N <sub>2</sub> (24 mL/min)<br>With He carrier gas: He (24 mL/min) |

\*: Only when using He

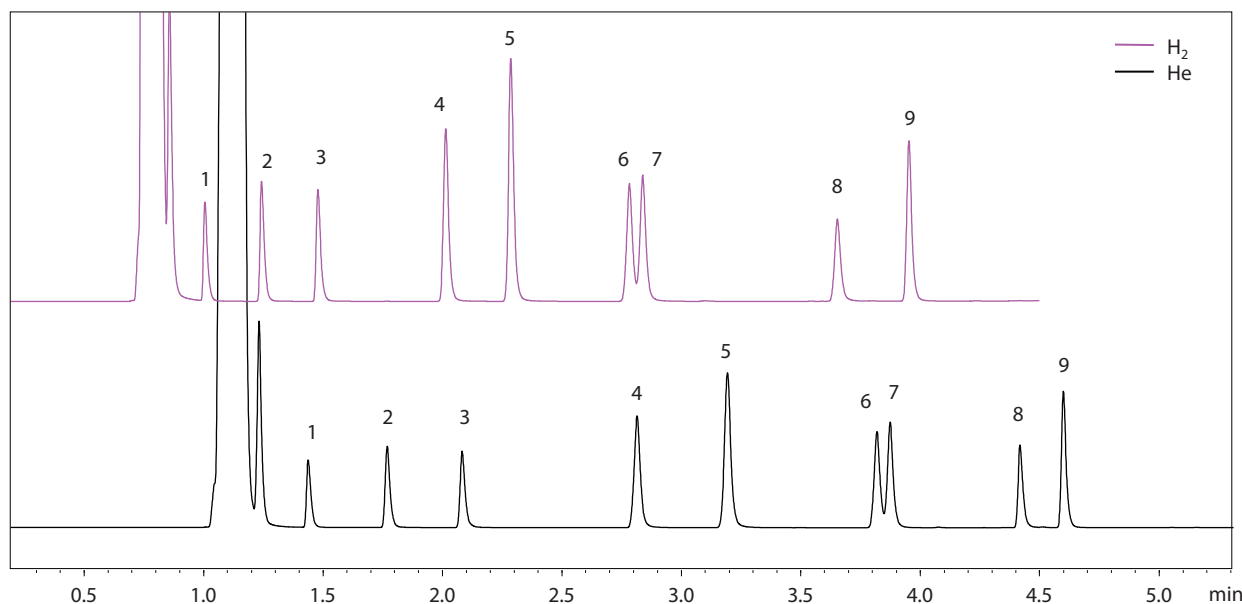
A mixed solution of organic solvents was prepared by dissolving nine organic solvent species in hexane to contain 1000 ppm (v/v) of each solvent. Fig. 3 shows the obtained chromatograms.

The analysis time was shortened when using hydrogen carrier gas. The linear velocity and the injection port pressure at the initial column temperature was 55.4 cm/s and 371.5 kPa respectively. When using helium, the values were 38.4 cm/s and 594.7 kPa respectively.

Measurement was performed five times with hydrogen carrier gas. Table 3 shows the repeatability in the obtained area values and retention times. Favorable repeatability was obtained with all compounds.

**Table 3 Repeatability with each Compound Species (n = 5)**

| No. | Compound Name                     | Area Value %RSD | Retention Time %RSD |
|-----|-----------------------------------|-----------------|---------------------|
| 1   | Acetone                           | 0.725           | 0.007               |
| 2   | Ethyl acetate                     | 0.816           | 0.010               |
| 3   | Isopropyl alcohol (IPA)           | 0.700           | 0.017               |
| 4   | Methyl isobutyl ketone (MiBK)     | 0.835           | 0.014               |
| 5   | Toluene                           | 0.831           | 0.017               |
| 6   | Butyl acetate                     | 1.119           | 0.017               |
| 7   | 2-Hexanone (MBK)                  | 0.667           | 0.018               |
| 8   | Propylene glycol monomethyl ether | 0.763           | 0.017               |
| 9   | n-Butanol                         | 0.835           | 0.014               |



**Fig. 3 Chromatograms of Mixed Solution of Organic Solvents (Pink: H<sub>2</sub> Carrier Gas, Black: He Carrier Gas)**

First Edition: Nov. 2017



For Research Use Only. Not for use in diagnostic procedure.

This publication may contain references to products that are not available in your country. Please contact us to check the availability of these products in your country.

The content of this publication shall not be reproduced, altered or sold for any commercial purpose without the written approval of Shimadzu. Shimadzu disclaims any proprietary interest in trademarks and trade names used in this publication other than its own. See <http://www.shimadzu.com/about/trademarks/index.html> for details.

The information contained herein is provided to you "as is" without warranty of any kind including without limitation warranties as to its accuracy or completeness. Shimadzu does not assume any responsibility or liability for any damage, whether direct or indirect, relating to the use of this publication. This publication is based upon the information available to Shimadzu on or before the date of publication, and subject to change without notice.

Shimadzu Corporation

[www.shimadzu.com/an/](http://www.shimadzu.com/an/)



# Application News

## No. G299

### Gas Chromatography

## Example Analysis Using a Highly Sensitive Trace Moisture Analysis System Measurement of Moisture in Chlorofluorocarbon Gas and High-Purity Nitrogen Gas

The highly sensitive Trace Moisture Analysis System employs a sampling system for measuring trace moisture and therefore can prevent the inclusion of water at the time of sample injection. In addition, the system is equipped with an ionic liquid capillary column which enables separation of water and impurities, and Shimadzu's proprietary Barrier Ionization Discharge detector (BID-2030) which achieves detection of trace moisture with high sensitivity.

Chlorofluorocarbon gas and nitrogen gas are used widely in the fields of chemistry and semiconductors, but the presence of water in such gases in some cases hinders their use. It is therefore necessary to develop a system which can easily and accurately measure the amount of water contained in gas. Whereas other moisture meters sometimes cannot perform measurement at all due to the influence of impurities, the trace moisture analysis system can suppress the influence of impurities and achieve accurate measurements.

This article introduces an example of a high-sensitivity measurement of trace moisture contained in standard gases (chlorofluorocarbon gas and high-purity nitrogen gas) using the trace moisture analysis system.

T. Murata



### Trace Moisture Analysis System

As shown in Fig. 1, the trace moisture analysis system is a gas chromatography system which consists of the Nexis™ GC-2030 equipped with the BID-2030 barrier ionization discharge detector and a sampling system equipped with gas and liquid sampling valves.

In addition, an ionic liquid capillary column appropriate for the analysis of moisture is employed to allow high-sensitivity analysis of moisture which was difficult until now.

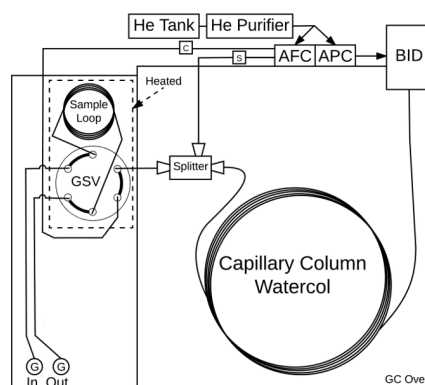


Fig. 1 Trace Moisture Analysis System

### Analysis of Standard Gas Containing Trace Moisture

A calibration curve was created by the absolute calibration curve method for helium standard gas (purchased from Takachiho Trading) containing water at concentrations of 10 ppm and 100 ppm respectively. Table 1 lists the analytical conditions and Fig. 2 shows the chromatograms of the standard gases.

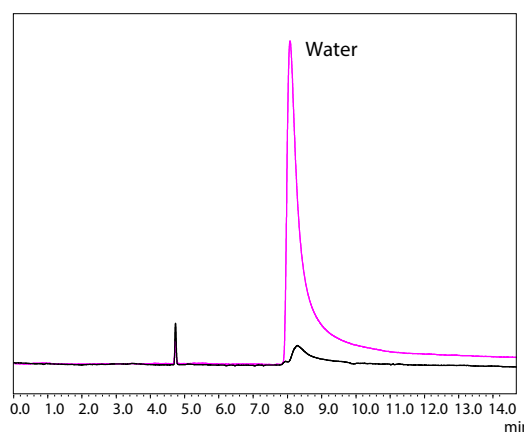


Fig. 2 Chromatograms of Helium Standard Gas Containing Trace Moisture (Black: 10 ppm, Red: 100 ppm)

Table 1 Analytical Conditions

|                        |   |
|------------------------|---|
| Model                  | : Nexis™ GC-2030  |
| Detector               | : BID-2030 barrier discharge ionization detector          |
| Column                 | : Watercol™-1910<br>(0.25 mm I.D. × 60 m, d.f. = 0.20 μm) |
| Column Temperature     | : 100 °C iso-thermal Total 15 min                         |
| Injection Mode         | : Split 1:25 (Splitter INJ)                               |
| Carrier Gas Controller | : Column flow rate 1.72 mL/min (He)                       |
| Linear Velocity        | : 30 cm/sec   |
| Detector Temperature   | : 230 °C  |
| BID Discharged Gas     | : 50 mL/min (He)  |
| Flow Rate              |   |
| Injection Volume       | : 1 mL (MGS-2030 Sample Loop)                             |

### High-Sensitivity Measurement of Trace Moisture in Chlorofluorocarbon Gas and High-Purity Nitrogen Gas

Pure gases of CF<sub>4</sub> chlorofluorocarbon and high-purity nitrogen N<sub>2</sub> were analyzed using the trace moisture analysis system. Figs. 3 and 4 compare the obtained chromatograms with the chromatogram of the helium standard gas containing water at 10 ppm respectively.

The amount of water in the pure gases was obtained using the water peak detected from each pure gas according to the absolute calibration curve method.

Use of the trace moisture analysis system allowed measurement of trace moisture contained in gas at concentrations of 5 ppm and lower. The obtained results indicate that the detection limit (S/N ratio  $\approx$  3) of this system regarding water measurement is about 0.8 ppm showing that trace moisture in gas was measured successfully with high sensitivity.

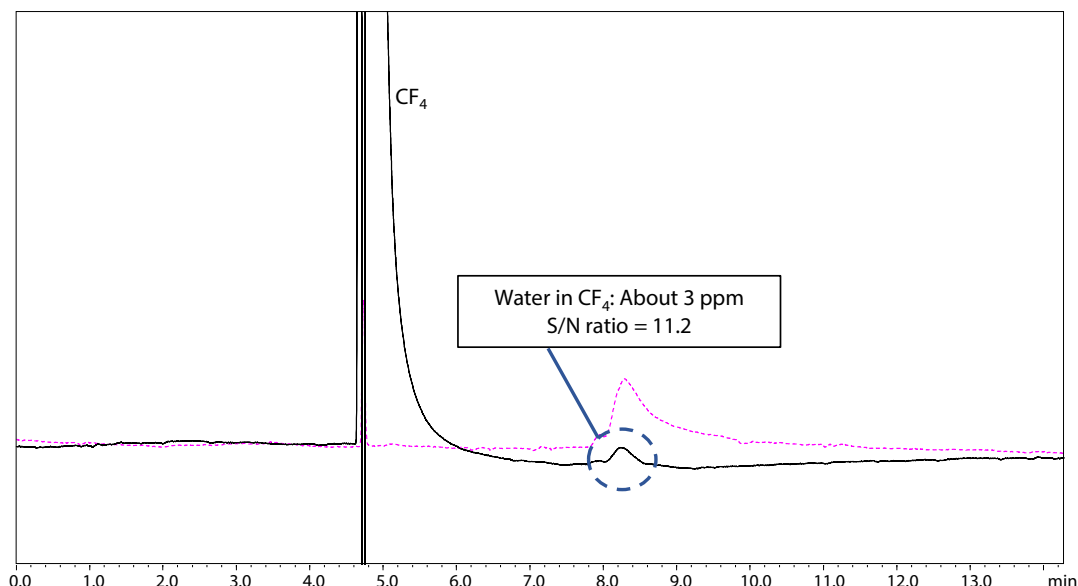


Fig. 3 Comparison of Chromatograms from CF<sub>4</sub> Chlorofluorocarbon Gas (Solid line) and Helium Standard Gas Containing Water at 10 ppm (Dotted line)

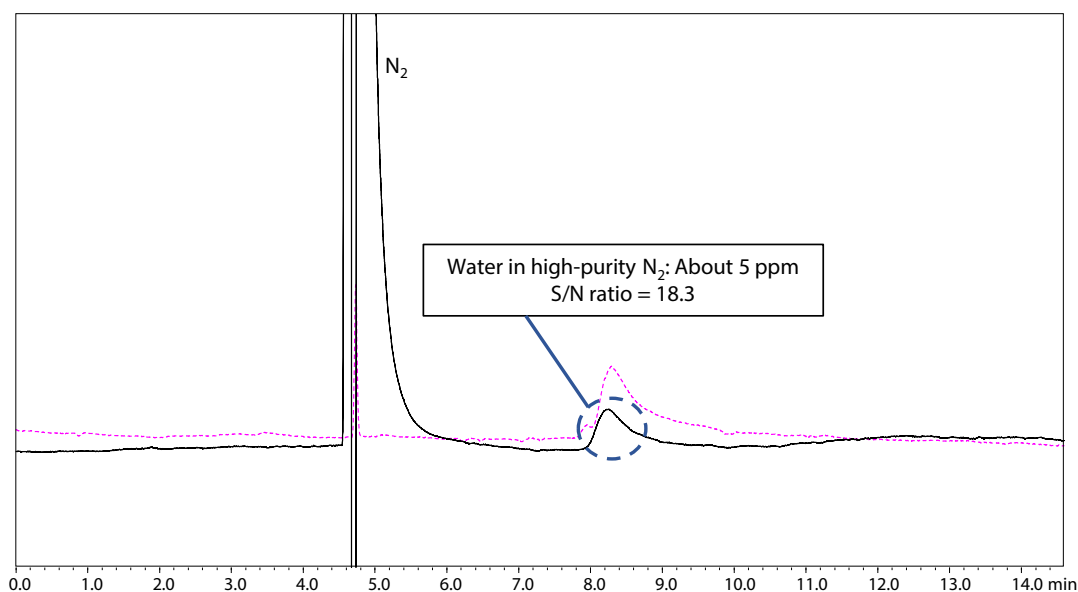


Fig. 4 Comparison of Chromatograms from High-Purity Nitrogen N<sub>2</sub> (Solid line) and Helium Standard Gas Containing Water at 10 ppm (Dotted line)

Nexis is a trademark of Shimadzu Corporation.  
Watercol is a trademark of Sigma-Aldrich Co. LLC.

First Edition: Mar. 2018



For Research Use Only. Not for use in diagnostic procedure.

This publication may contain references to products that are not available in your country. Please contact us to check the availability of these products in your country.

The content of this publication shall not be reproduced, altered or sold for any commercial purpose without the written approval of Shimadzu. Shimadzu disclaims any proprietary interest in trademarks and trade names used in this publication other than its own. See <http://www.shimadzu.com/about/trademarks/index.html> for details.

The information contained herein is provided to you "as is" without warranty of any kind including without limitation warranties as to its accuracy or completeness. Shimadzu does not assume any responsibility or liability for any damage, whether direct or indirect, relating to the use of this publication. This publication is based upon the information available to Shimadzu on or before the date of publication, and subject to change without notice.

Shimadzu Corporation

[www.shimadzu.com/an/](http://www.shimadzu.com/an/)

## A Pyrolysis-GC/MS Screening System for Analysis of Phthalate Esters and Brominated Flame Retardants

### ■ Introduction

The Restriction of Hazardous Substances (RoHS) Directive controls six hazardous substances commonly used in electronic and electrical equipment <sup>(1)</sup>. Two of the restricted substances are compound classes commonly used in flame retardants: polybrominated biphenyls (PBB) and polybrominated diphenyl ethers (PBDE), both known to cause serious health concerns due to their high halogen content. Beside brominated flame retardants, phthalate esters have also been controlled by a number of regulatory authorities. The United States congress has prohibited the use of six specified phthalate esters (DBP, DEHP, BBP, DINP, DIDP and DnOP) in children's toys at concentrations higher than 0.1% under the Consumer Product Safety Improvement Act of 2008 (CPSIA) <sup>(2)</sup>. The European commission has identified DBP, DEHP and BBP as reproductive toxicants under directive 2005/84/EC <sup>(3)</sup>. The Environmental Protection Agency (EPA) has proposed adding eight phthalates to the list of chemicals of concern under the Toxic Substances Control Act (TSCA), including DIBP, DBP, BBP, DEHP, DnOP, DINP, DnPP and DIDP <sup>(4)</sup>. The Food and Drug Administration (FDA) Center for Drug Evaluation and Research (CDER) recommends avoiding the use of DBP and DEHP as excipients in CDER-regulated drug and biologic products, including prescription and nonprescription products <sup>(5)</sup>.

To quantitate these substances in a polymer matrix, the traditional approach involves solvent extraction of PBBs, PBDEs and phthalate esters from the sample matrix, followed by detection and quantitation by gas chromatography/mass spectrometry (GC/MS). This method is time consuming and poses the risk of exposure to multiple toxic solvents.

Pyrolysis followed by GC/MS has been well established for detection of volatile and semi-volatile compounds in both natural and synthetic polymers. Using the pyrolysis technique described here, a temperature programed micro-furnace provides thermal desorption processes at two temperature

ranges, releasing the PBBs, PBDEs and phthalate esters from the polymer matrix for subsequent analysis by GC/MS.

In this application note, a PY-GC/MS method has been used to screen for seven phthalate esters and 11 brominated flame retardants. A commercially available method package was used, which includes phthalate ester and PBDE standards, pre-registered instrument methods with acquisition and data processing parameters, and calibration curves for semi-quantitative calculation of compound concentration. Quantitation results were generated with minimal sample preparation, requiring no organic solvents. A software program for efficient multi-analyte data confirmation and QAQC review is also discussed.

### ■ Experimental

#### *Py-Screener Package*

This study was conducted using the Shimadzu GCMS-QP2010 Ultra, Frontier Multi-Shot EGA/PY-3030D pyrolyzer, and AS-1020E Auto-Shot sampler, as shown in Figure 1.



**Figure 1:** Frontier Multi-Shot EGA/PY-3030D pyrolyzer and AS-1020E Auto-Shot sampler installed on the Shimadzu GCMS-QP2010 Ultra

The Frontier Multi-Shot EGA/PY-3030D pyrolyzer and AS-1020E Auto-Shot sampler were installed on the Shimadzu GCMS-QP2010 Ultra, with a UA-PBDE metal capillary column (15 m x 0.25 mm x 0.05 µm). A method package called Py-Screener has been developed and applied in this application. Py-Screener is a method package targeting seven phthalates and 11 brominated flame retardants. It contains pre-registered instrument acquisition methods for the Pyrolyzer and the GC/MS, as well as a data processing analysis method including quantitation parameters and calibration curves developed using phthalate and PBDE standards. Refer to Table 1 and Table 2 for experimental details and complete compound list.

Analytical standards used for this project were included with the Py-Screener package. The phthalate standards were comprised of three thin polymer films, which contain seven phthalates at 0, 100 ppm, and 1000 ppm, and one flame retardant standard containing 11 PBBs and PBDEs. All standards and samples were prepared by slicing off small pieces of the polymer using the knife from the sampling tool kit. Approximately 0.5 mg of standards and samples were weighed using an electronic balance with accuracy of 0.01 mg before loading into the sample cups. For ease of the application, the Py-Screener package also includes sample preparation videos, illustrated troubleshooting procedures and routine maintenance.

**Table 1:** Experimental conditions for the instrument acquisition method

| <b>Gas Chromatograph</b>        |  | <b>CG-2010 Plus</b>   |  |
|---------------------------------|--|---|--|
| Column                          | UA-PBDE, 15 m x 0.25 mm x 0.05 µm (Shimadzu PN 220-94824-20)   |   |  |
| Oven Program                    | 80 °C, no hold<br>20 °C/minute to 300 °C, hold 5 minutes   |   |  |
| Injector                        | Split mode, split ratio 50:1<br>300 °C<br>Split Liner w/ wool (Shimadzu PN 220-90784-00)   |   |  |
| Carrier Gas<br>Carrier Gas Flow | Helium<br>Constant linear velocity mode, 52.1 cm/second<br>Total Flow 54 mL/minute, Column Flow = 1.00 mL/minute<br>Purge Flow 3.0 mL/minute |   |  |
| Interface Temperature           | 320 °C   |   |  |
| <b>Mass Spectrometer</b>        |  | <b>GCMS-QP2010 Ultra</b>  |  |
| Ion Source Temperature          | 230 °C   |   |  |
| Solvent Cut Time                | 0.5 minutes  |   |  |
| Detector Voltage                | Relative to tune + 0.1 kV  |   |  |
| MS Operating Mode               | Acquisition mode: Scan/SIM<br>Total loop time 0.45 second  |   |  |
|                                 | Scan event time 0.15 second  | SIM event time 0.3 second<br>SIM method details listed in table 2 |  |
| Mass range:                     | 50-1000 amu  |   |  |
| <b>Pyrolyzer</b>                |  | <b>PY-3030D (Frontier Labs)</b>                                   |  |
| Sample amount                   | 0.5 mg   |   |  |
| Furnace Temp                    | TD1 200 °C to 300 °C @ 20 °C/minute, total 5 minutes<br>TD2 300 °C to 340 °C @ 5 °C/minute, total 9 minutes                                  |   |  |
| PY-GC Interface Temperature     | Furnace temperature plus 100 °C, up to 300 °C  |   |  |
| <b>Analysis Time</b>            |  |   |  |
| PY program                      | 14 minutes   |   |  |
| GC/MS program                   | 16 minutes   |   |  |
| Total Cycle Time per sample     | 30 minutes   |   |  |

**Table 2:** Compound list and selected ions for the SIM method

| Compound Name   | Abbreviation / Congeners | Selected Ions for the SIM Mode |              |              |
|---|--------------------------|--------------------------------|--------------|--------------|
|   |                          | Quantitation                   | Reference #1 | Reference #2 |
| Diisobutyl phthalate  | DIBP                     | 223.0                          | 205.0        | 149.0        |
| Dibutyl phthalate   | DBP                      | 223.0                          | 205.0        | 149.0        |
| Butyl benzyl phthalate  | BBP                      | 206.0                          | 91.0         | 149.0        |
| Di(2-ethylhexyl) phthalate  | DEHP                     | 279.0                          | 167.0        | 149.0        |
| Di( <i>n</i> -octyl) phthalate  | DnOP                     | 279.0                          | 167.0        | 149.0        |
| Diisononyl phthalate  | DINP                     | 293.0                          | 167.0        | 149.0        |
| Diisodecyl phthalate  | DIDP                     | 307.0                          | 167.0        | 149.0        |
| Hexabromocyclododecane  | HBCDD                    | 238.9                          | 560.6        |              |
| 2,2',4,4'-tetrabromodiphenyl ether  | BDE-47                   | 325.8                          | 483.6        |              |
| 2,2',3,4,4'-pentabromodiphenyl ether  | BDE-99                   | 403.8                          | 561.6        |              |
| 2,2',4,4',6-pentabromodiphenyl ether  | BDE-100                  | 403.8                          | 561.6        |              |
| 2,2',4,4',5,5'-hexabromodiphenyl ether  | BDE-153                  | 483.6                          | 643.5        |              |
| 2,2',4,4',5,6'-hexabromodiphenyl ether  | BDE-154                  | 483.6                          | 643.5        |              |
| 2,2',3,4,4',5,6'-heptabromodiphenyl ether   | BDE-183                  | 561.6                          | 721.4        |              |
| 2,2',3,3',4,4',6,6'-Octabromodiphenyl ether +<br>2,2',3,4,4',5,6,6'-Octabromodiphenyl ether | BDE-197+204              | 641.5                          | 643.5        |              |
| Nonabromodiphenyl ethers  | BDE-206+207+208          | 719.4                          | 879.2        |              |
| Decabromodiphenyl ether   | BDE-209                  | 799.3                          | 959.1        |              |
| Decabrominated biphenyl   | BB-209                   | 783.3                          | 785.3        |              |

#### *PY-GC/MS Method*

In the micro-furnace of the pyrolyzer, the sample undergoes a two-step thermal desorption process, where the temperature increases from 200 °C to 300 °C at 20 °C per minute, followed by a second temperature ramp from 300 °C to 340 °C at 5 °C per minute. PBBs, PBDEs and phthalate esters are released in the temperature controlled micro-furnace and are transferred to GC/MS for chromatographic separation and analysis.

A simultaneous selected ion monitoring (SIM) and full scan acquisition method (Scan/SIM) was used on the GCMS-QP2010 Ultra. Using a Scan/SIM method provides enhanced sensitivity of the target compounds by monitoring their signature fragments, while simultaneously screening for the unknown analytes in the full mass range at the same time. Because analysis takes place by rapidly alternating between the two modes, a fast scan rate is essential to assure adequate sensitivity for both SIM and full scan modes.

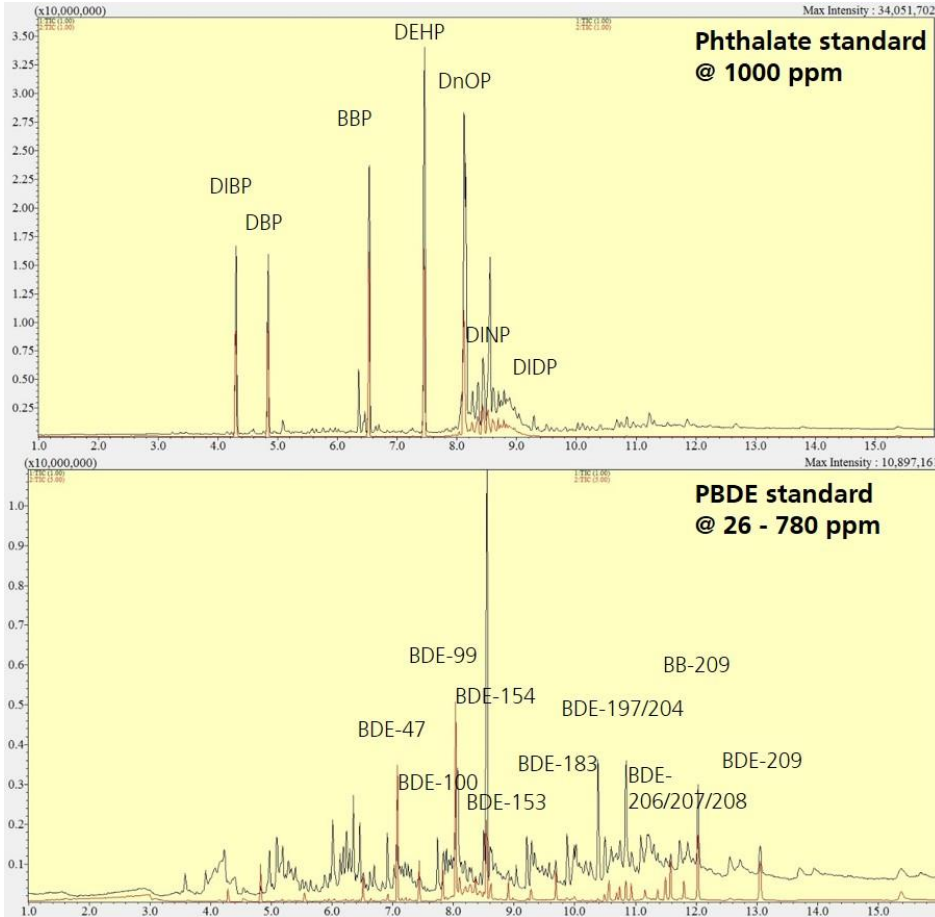
The Py-Screener method package includes pre-registered retention indices for all the target compounds. Retention time for the target compounds are determined using the retention indices and the retention time for the homologous

series of hydrocarbons under the same acquisition conditions using Automatic Adjust of Retention Time (AART) function. A mixture containing saturated hydrocarbon *n*-isomers from Octane (C8) to Tetracontane (C40) comes with the package and is used in the AART function. Retention time of all 18 target compounds is predicted and is used to adjust the acquisition and data processing retention time parameters in the method.

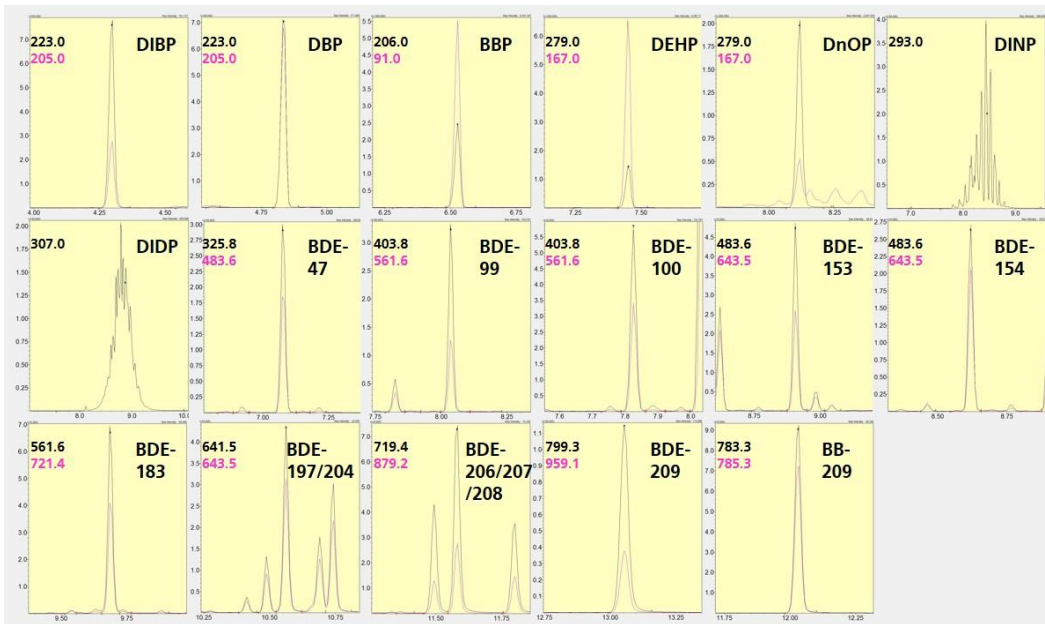
#### ■ Results and Discussion

##### *Calibration Standards*

Four standards were analyzed using the Scan/SIM method, which include three standards with phthalates at 0 ppm, 100 ppm and 1000 ppm, and one with PBDEs at various concentration between 26 ppm and 780 ppm. Total ion chromatograms (TIC) for two standards are shown in Figure 2. Figure 3 shows the SIM chromatographic profiles for the individual target compounds. DIBP, DBP, BBP, DEHP, and DnOP present as narrow sharp chromatographic peaks, while the profiles for DINP and DIDP present as a broad cluster of chromatographic peaks due to their multiple isomeric components. The area count of mass chromatogram in SIM mode for each compound was determined, and applied to the calibration curve in the quantitation method.



**Figure 2:** Total ion chromatograms (TIC) for the phthalate and PBDE standards, with full scan mode shown in black and SIM mode shown in red. Phthalate standard contains seven phthalates at 1000 ppm. The PBDE standard contains PBDEs and PBBs at various concentrations between 26 and 780 ppm.

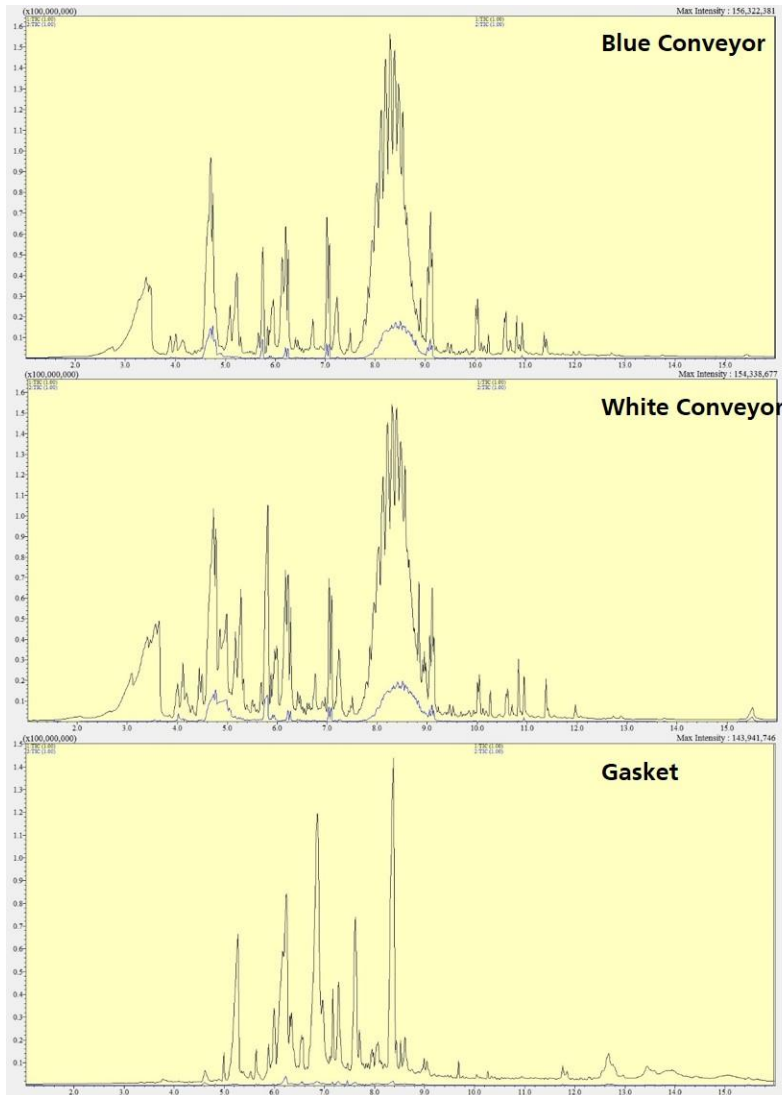


**Figure 3:** Chromatographic profile of the target compounds extracted from SIM chromatogram of the phthalate and PBDE standards. The primary SIM ions are shown in black, and the secondary reference ions are shown in pink.

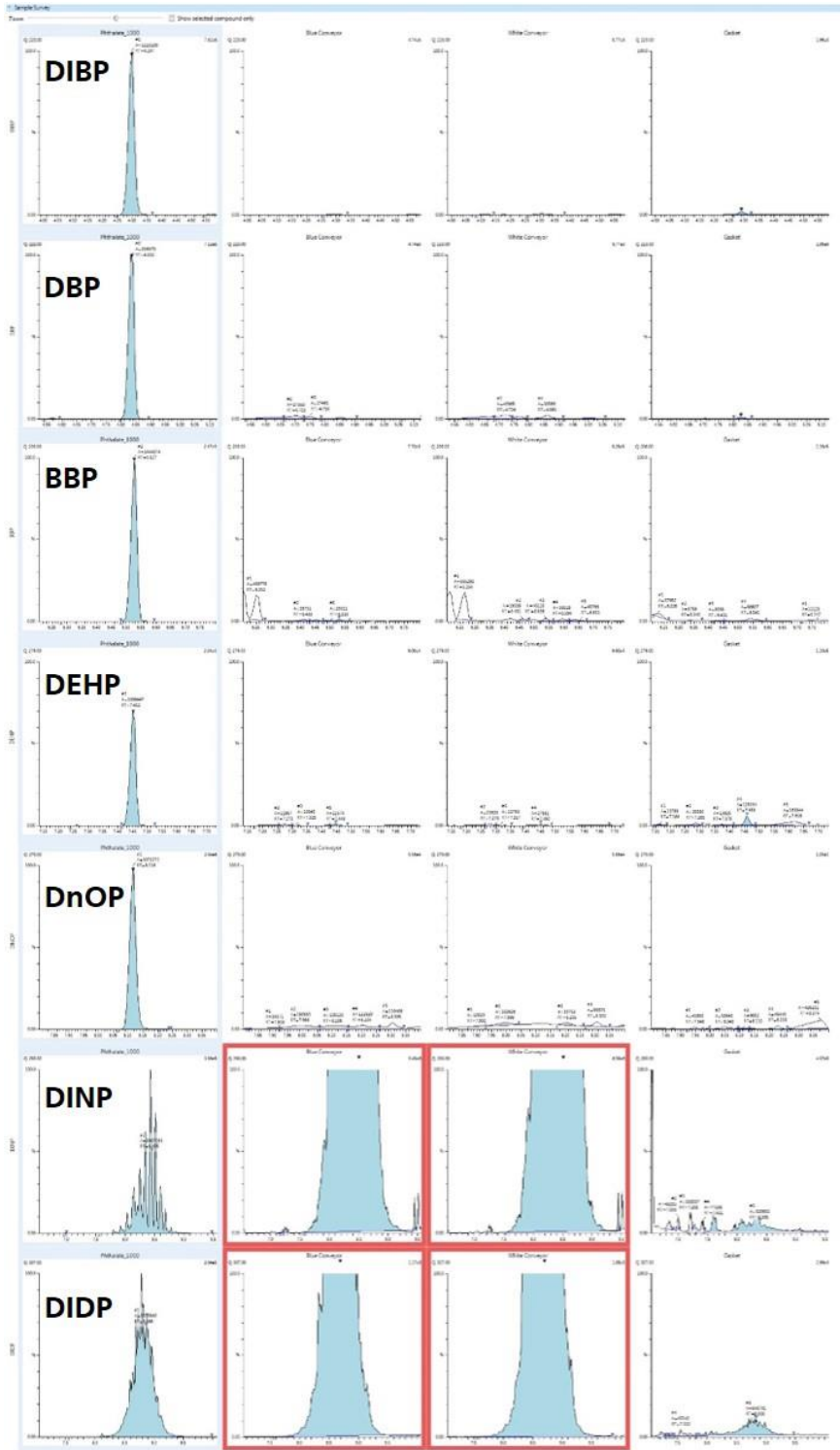
### LabSolution Insight

LabSolution Insight is a software program designed for simultaneously analyzing data sets from multiple samples. With LabSolution Insight, quantitative results for a complete series of data files can be displayed side-by-side for comparison and QC review. All of the chromatograms from a selected target compound can be displayed simultaneously, making it easy to review the detected peaks and confirm the quantitative results. Color-coded QA/QC flags quickly identify any outliers that require further examination. Results can be displayed in a variety of ways, allowing users to select the view that is best suited for their workflow, and when necessary, peaks can be re-integrated and re-quantified directly from LabSolution Insight.

For this project three polymer samples were analyzed using the PY-GC/MS method described above; they are labeled Blue Conveyor, White Conveyor, and Gasket. A blank sample cup was also analyzed using the same method for quality control purpose. Figure 4 shows the total ion chromatograms of the three polymer samples. The pre-registered calibration curve from the Py-Screener package was used for quantitation. The calibration is based on a one-point calibration from analysis of the highest phthalate standard at 1000 ppm, and the PBDE standard. The quantitation results are categorized into three groups to comply with multiple regulations: below 500 ppm, between 500 and 1500 ppm, and beyond 1500 ppm. All 7 target phthalate compounds from one standard and the three samples are displayed side-by-side in LabSolution Insight, and the outliers with concentration above 1500 ppm are labeled with flags, as shown in Figure 5.



**Figure 4:** Total ion chromatogram from three samples - *Blue Conveyor*, *White Conveyor*, and *Gasket*, with full scan mode shown in black and selected ion monitoring (SIM) mode shown in blue. Note that the noise level in SIM mode is reduced significantly compared to full scan mode.



**Phthalate STD @ 1000 ppm** **Blue Conveyor White Conveyor Gasket**

**Figure 5:** Quantitative analysis of the seven phthalate analytes in one standard and three polymer samples using the LabSolution Insight QAQC software. All the phthalate target compounds from three samples with unknown phthalate concentration are displayed with intensity scaled at the same level as phthalate standard at 1000 ppm. Phthalate content higher than 1500 ppm have been automatically flagged with a red box by the LabSolution Insight software.



The two samples labeled Blue Conveyor and White Conveyor have similar chromatographic profiles, which both show significant phthalate content compared to the Gasket sample. Quantitative analysis results on the blank and the three polymer samples are shown in table 3. DINP and DIDP were detected at around 3% and 0.7% in both Blue

Conveyor and White Conveyor samples, which exceed the 0.1% limit in several regulations. The Gasket sample shows only low content of DINP and DIDP at about 0.03% and 0.02%. All the other types of phthalates and PBDEs are either negligible or non-detected in all the three samples.

**Table 3:** Quantitative analysis result of three polymer samples

| Compound Name          | Blank (ppm) | Blue Conveyor (ppm) | White Conveyor (ppm) | Gasket (ppm) |
|------------------------|-------------|---------------------|----------------------|--------------|
| DIBP                   | ND          | ND                  | ND                   | 23           |
| DBP                    | 1           | ND                  | ND                   | 11           |
| BBP                    | < 1         | 9                   | ND                   | ND           |
| DEHP                   | < 1         | 12                  | 11                   | 81           |
| DNOP                   | ND          | ND                  | ND                   | ND           |
| DINP                   | ND          | 31489               | 31722                | 297          |
| DIDP                   | ND          | 7149                | 7860                 | 192          |
| HBCDD                  | ND          | ND                  | ND                   | ND           |
| Tetra-BDE (BDE-47)     | ND          | ND                  | ND                   | ND           |
| Penta-BDE (BDE-100)    | ND          | ND                  | ND                   | ND           |
| Penta-BDE (BDE-99)     | ND          | ND                  | ND                   | ND           |
| Hexa-BDE (BDE-154)     | ND          | ND                  | ND                   | ND           |
| Hexa-BDE (BDE-153)     | ND          | ND                  | ND                   | ND           |
| Hepta-BDE (BDE-183)    | ND          | ND                  | ND                   | ND           |
| Octa-BDE (BDE-197+204) | ND          | ND                  | ND                   | ND           |
| Nona-BDE               | ND          | ND                  | ND                   | ND           |
| Deca-BDE (BDE-209)     | ND          | ND                  | ND                   | ND           |

#### QAQC

Phthalate standards at 0 ppm and 100 ppm were analyzed using the same method to support quality control. In LabSolution Insight, QAQC criteria were applied so that the data will be highlighted when either of the following two conditions was met: the concentration of any of the target compounds in 0 ppm standard exceeds 10 ppm, or the signal to noise ratio of 100 ppm standard falls below 30.

Since the Py-Screener package was developed for phthalate and PBDE screening for several regulations, the quantitation is only adequate enough to be categorized in those three groups. To achieve further accuracy, sohexlet extraction followed by liquid injection GC/MS will be required. Regular liquid injection with capillary column Rxi-1HT (15 m x 0.25 mm x 0.1 µm) is recommended instead of pyrolysis. In this case, the Twin Line MS kit can be used to save time on column switching

#### ■ Summary and Conclusion

The Py-Screener method package was used to investigate the phthalates and PBDEs content in three polymer samples. Experimental conditions and data processing method are described in detail. The LabSolution Insight program was used to review multiple data and flag outliers based on defined QAQC parameters.

#### ■ References

1. Directive 2002/95/EC, Official Journal of the European Union
2. Public law 110-314, Consumer Product Safety Improvement Act of 2008
3. Directive 2005/84/EC, Official Journal of the European Union
4. Phthalates action plan, U.S. Environmental Protection Agency
5. Guidance for industry limiting the use of certain phthalates as excipients in CDER-regulated products, U.S. Department of Health and Human Services Food and Drug Administration Center for Drug Evaluation and Research



SHIMADZU Corporation  
www.shimadzu.com/an/

SHIMADZU SCIENTIFIC INSTRUMENTS  
7102 Riverwood Drive, Columbia, MD 21046, USA  
Phone: 800-477-1227/410-381-1227, Fax: 410-381-1222  
URL: www.ssi.shimadzu.com

First Edition: September 2015

For Research Use Only. Not for use in diagnostic procedures.  
The contents of this publication are provided to you "as is" without warranty of any kind, and are subject to change without notice.  
Shimadzu does not assume any responsibility or liability for any damage, whether direct or indirect, relating to the use of this publication.

# Application News

## No. A494

### Spectrophotometric Analysis

## Simplified Measurement of Coumarin in Diesel Oil

### ■ Introduction

In Japan, diesel oil is subject to a consumption tax (national tax) and a diesel oil delivery tax (regional tax). However, kerosene and low-sulfur / high-sulfur A fuel oil are not subject to the delivery tax. Therefore, to avoid the tax, some vendors have been known to sell fraudulent diesel oil that has been mixed with kerosene or fuel oil. As a countermeasure, starting in March 1991, the then Ministry of Trade and Industry required addition of a 1 ppm concentration of coumarin to commercial kerosene and low-sulfur / high-sulfur A fuel oil products, so that they can be easily identified. Consequently, local tax bureaus have been using this marker for inspecting diesel oil by random sampling. If coumarin is detected, it means kerosene or low-sulfur / high-sulfur A fuel oil was mixed in with the diesel oil and legal measures or other actions are taken against the violator.

Therefore, on December 10, 2010, the Japan Petroleum Institute (Testing and Analysis sub-committee of the Product committee) established standard JPI-55-71-2010 as the official method for analyzing coumarin. In this example, we used Method A of the standard to measure the fluorescence spectrum of coumarin.

### ■ Analytical Procedure

The procedure for analyzing coumarin is summarized below and a photograph of the RF-6000 spectrofluorophotometer used to identify the coumarin diesel oil marker substance is shown in Fig. 1. Equipment and reagents required for the analysis are listed in Table 1.

#### Analytical Procedure

- (1) Prepare various solutions.
- (2) Prepare a standard sample for creating a calibration curve.
- (3) Prepare sample for quantitative analysis.
- (4) Shake and isomerize (UV irradiation).
- (5) Prepare calibration curve.
- (6) Measure unknown sample.



Fig. 1 RF-6000 Spectrofluorophotometer Coumarin (Diesel Oil Marker) Identification System

Table 1 Equipment and Reagents Required for Coumarin Analysis

|      |  |
|------|--|
| (1)  | RF-6000 spectrofluorophotometer system                                       |
| (2)  | Coumarin analysis kit (test tube holder with stirrer)                        |
| (3)  | Dedicated coumarin measurement test tube (with stirrer)                      |
| (4)  | Volumetric flasks (100 mL, 200 mL, and 500 mL)                               |
| (5)  | Volumetric pipettes (1 mL, 2 mL, 5 mL, 6 mL, 8 mL, and 10 mL)                |
| (6)  | Measuring pipettes (0.5 mL, 1 mL, 2 mL, and 10 mL)                           |
| (7)  | Test tube stand for 23 mm diameter tubes                                     |
| (8)  | Disposable gloves  |
| (9)  | Coumarin   |
| (10) | Toluene  |
| (11) | n-Dodecane   |
| (12) | Sodium hydroxide and sodium nitrate for preparing alkaline aqueous solutions |
| (13) | 1-Butanol and ethanol reagents for preparing alcohol solutions               |

Note: Items (9), (12), and (13) can be substituted with the Shimadzu RF Quantitation Reagent Kit.  
A test tube shaker would also be helpful.

■ **Preparing Solutions**

Prepare each solution according to steps (a) to (e) below.

- (a) Coumarin standard stock solution (10,000 mg/L)  
(Can be stored for 3 months in a sealed container in a cool dark location)  
Accurately weigh  $1.0 \pm 0.005$  g of coumarin into a 100 mL volumetric flask and fill to volume with toluene.
- (b) Coumarin standard solution (100 mg/L)  
Measure 5 mL of the coumarin standard stock solution (a) with a volumetric pipette and place it in a 500 mL volumetric flask. Then fill to volume with n-dodecane.
- (c) Coumarin standard solution (1 mg/L)  
Measure 5 mL of coumarin standard solution (b) with a volumetric pipette and place it in a 500 mL volumetric flask. Then fill to volume with n-dodecane.
- (d) Alkaline aqueous solution (can be stored sealed for 1 month in a cool dark location)  
Weigh  $10 \pm 0.1$  g sodium hydroxide and  $20 \pm 0.1$  g sodium nitrate and place them in a 100 mL volumetric flask. Then fill to volume with water.
- (e) Alcohol solution (can be stored sealed for 1 month in a cool dark location)  
Mix 80 mL 1-butanol and 60 mL ethanol.

■ **Preparing Measurement Samples and Standard Samples for Creating a Calibration Curve**

Insert stirrers in five test tubes used for creating the calibration curve. Then dispense the solutions indicated in Table 2. Prepare the measurement sample by inserting the stirrer in the test tube and then dispensing 1 mL of the measurement sample, 6 mL n-dodecane, 5 mL alkaline aqueous solution, and 8 mL alcohol solution.

■ **Shaking and Isomerization**

Install each test tube in the shaker and shake for three minutes at 240 rpm or faster. If a shaker is not available, shake by hand. Let stand for five minutes after shaking. Then confirm that the contents have separated into three layers, as shown in Fig. 2. From the top, these layers are the dodecane, alcohol solution, and alkaline aqueous solution layers.

Next, place the test tubes in the cell holder of the RF-6000 spectrofluorophotometer coumarin diesel oil marker identification system. Isomerize the coumarin by irradiating with 360 nm UV excitation wavelength (10 nm bandwidth) for three minutes while stirring with the stirrer. The isomerization progress can be checked by setting the fluorescence wavelength to 500 nm (10 nm bandwidth) and confirming the change in fluorescence intensity over time. Analytical conditions are indicated in Table 3. A time-course graph is shown in Fig. 3, with elapsed time on the horizontal axis and fluorescence intensity on the vertical axis. Irradiating samples with UV light causes the fluorescence intensity to increase with elapsed time. When the fluorescence intensity becomes constant isomerization is considered stabilized.

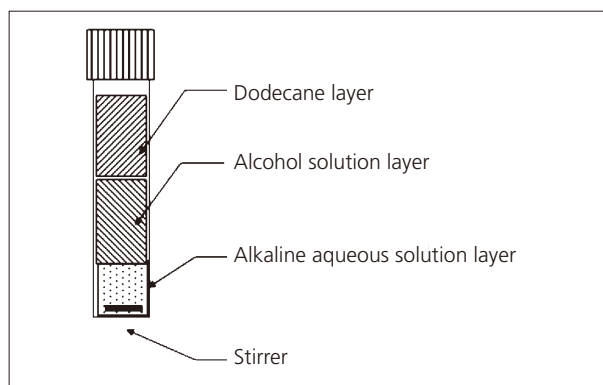


Fig. 2 Diagram of Test Tube Contents Separated into Three layers

Table 3 Analytical Conditions

|                       |                        |
|-----------------------|------------------------|
| Measurement mode      | : Time course          |
| Excitation wavelength | : 360 nm               |
| Emission wavelength   | : 500 nm               |
| Bandwidth             | : Ex: 10 nm, Em: 10 nm |

Table 2 Preparing Standard Samples for Creating Calibration Curve

| Types of Calibration Curves       | Mixture Ratio (%)                     | 0.0  | 10.0 | 40.0 | 80.0 | 120.0 |
|-----------------------------------|---------------------------------------|------|------|------|------|-------|
|                                   | Coumarin Content (mg/L)               | 0.00 | 0.10 | 0.40 | 0.80 | 1.20  |
| Reagent Acquisition Quantity (mL) | Coumarin Standard Solution (1.0 mg/L) | 0    | 0.10 | 0.40 | 0.80 | 1.20  |
|                                   | n-Dodecane                            | 7.0  | 6.9  | 6.6  | 6.2  | 5.8   |
|                                   | Alkaline Aqueous Solution             | 5.0  | 5.0  | 5.0  | 5.0  | 5.0   |
|                                   | Alcohol Solution                      | 8.0  | 8.0  | 8.0  | 8.0  | 8.0   |

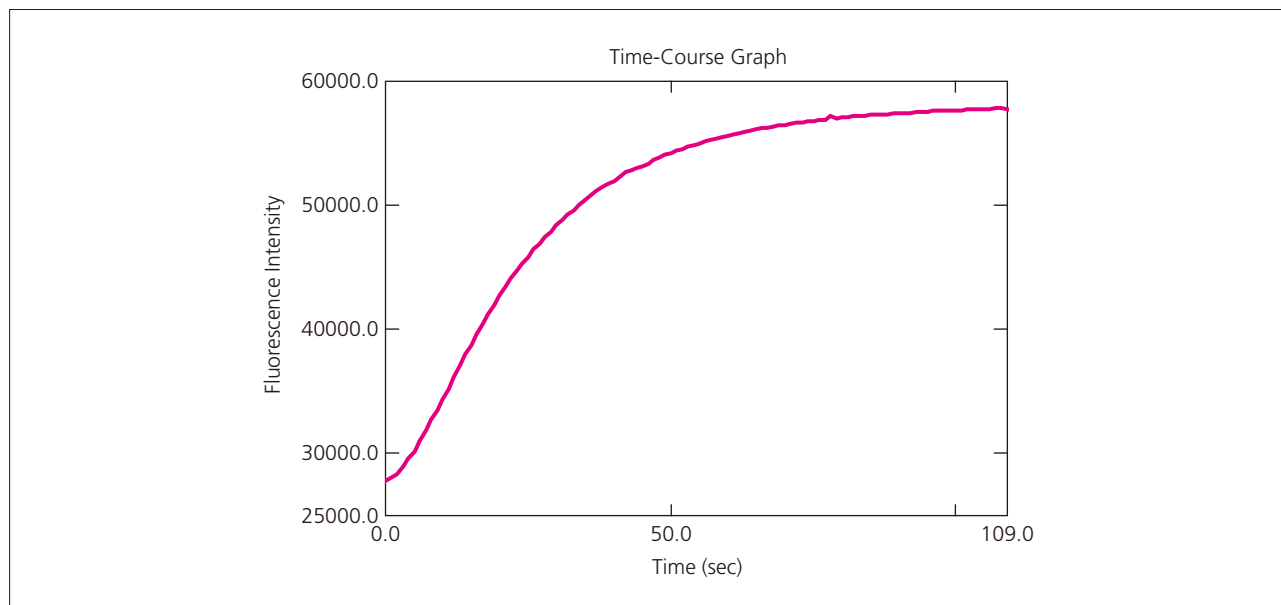


Fig. 3 Change in Fluorescence Intensity Due to Coumarin Isomerization

### ■ Isomerization Reaction of Coumarin

In an alkaline solution, coumarin breaks down by hydrolysis to form *cis*-*o*-hydroxycinnamic acid. If additionally irradiated with UV rays, it is isomerized to form *trans*-*o*-hydroxycinnamic acid. The structure of these isomers are shown in Fig. 4. When coumarin changes to *trans*-*o*-hydroxycinnamic acid, it emits fluorescent light. Coumarin can be quantitated by measuring the associated fluorescence intensity.

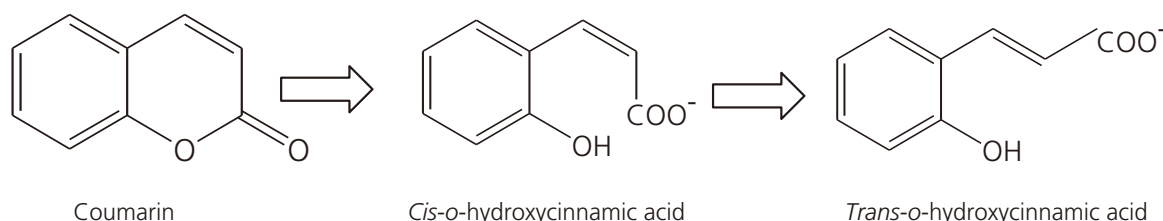


Fig. 4 Isomerization Reaction of Coumarin

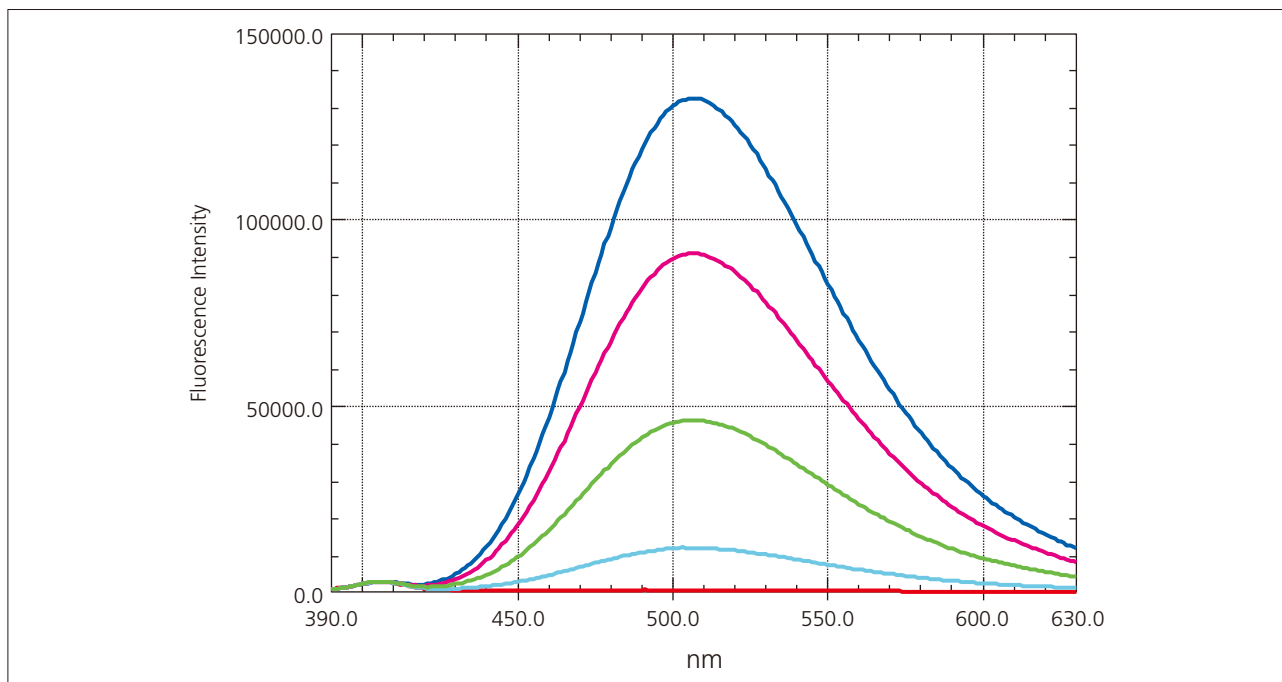
### ■ Preparing a Calibration Curve and Measuring Coumarin Added to Diesel Oil

After irradiation with UV light, samples are measured using the analytical conditions indicated in Table 4. The fluorescence spectrum measured from the standard sample is shown in Fig. 5. The calibration curve is shown in Fig. 6. The squared correlation coefficient of the calibration curve,  $r^2$ , was 0.99965.

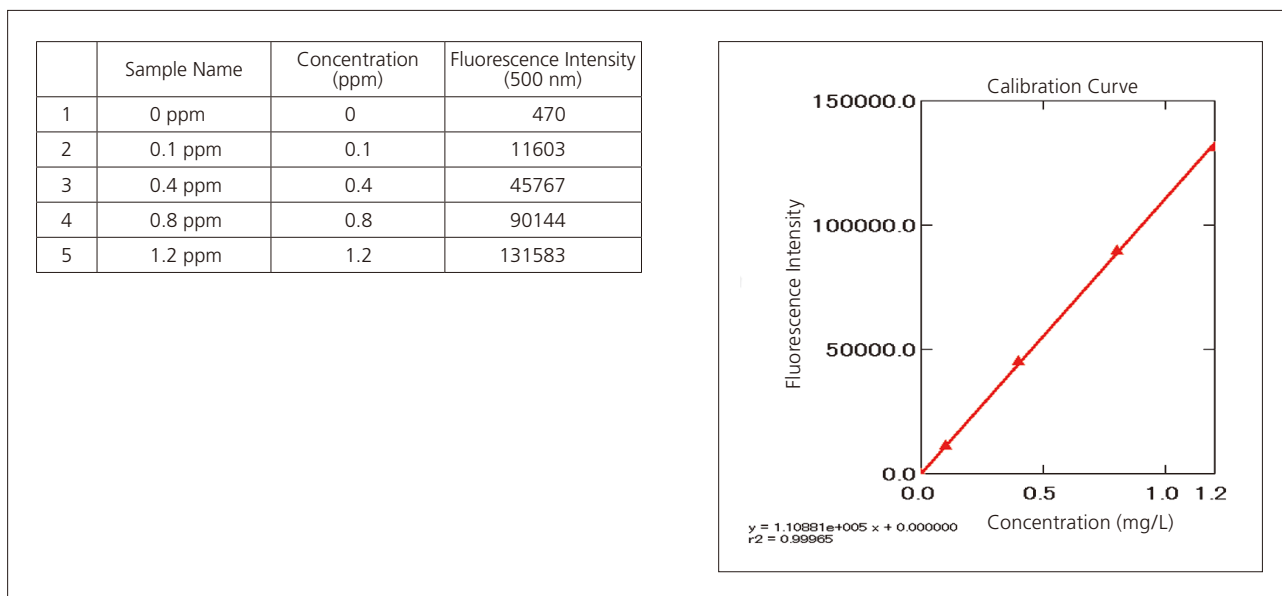
Results from measuring the measurement sample prepared by adding 0.5 ppm coumarin to commercial diesel oil are shown in Table 5. The quantitative results were approximately equivalent to the added quantity.

Table 4 Analytical Conditions

|                       |   |
|-----------------------|---|
| Excitation wavelength | :360 nm                                       |
| Emission wavelength   | :500 nm (390 to 630 nm when scanning spectra) |
| Bandwidth             | :EX: 10 nm, EM: 10 nm                         |



**Fig. 5 Fluorescence Spectra of Standard Samples**  
 In order of fluorescence intensity, with the highest intensity first, the corresponding concentrations are 1.2 ppm, 0.8 ppm, 0.4 ppm, 0.1 ppm, and 0 ppm.



**Fig. 6 Calibration Curve**

**Table 5 Measurement Results for Coumarin Added to Diesel Oil**

| Quantity Added (ppm) | Fluorescence Intensity | Measurement Result (ppm) |
|----------------------|------------------------|--------------------------|
| 0.50                 | 57440                  | 0.514                    |

**Conclusion**

This example showed that the Shimadzu RF-6000 spectrofluorophotometer can be used to easily and accurately measure coumarin according to Method A of the standard specified by the Japan Petroleum Institute.

# Application News

## No. 065

### Total Organic Carbon Analysis

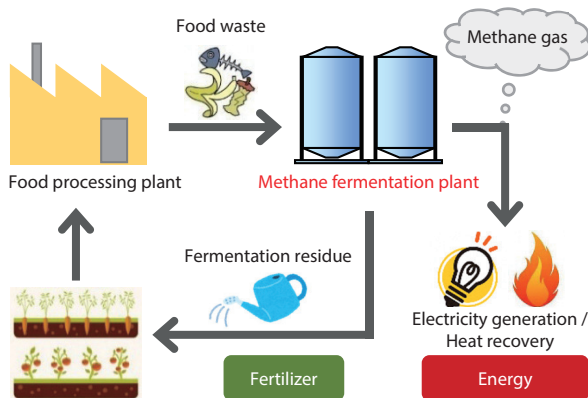
## TOC/TN Measurement for the Control and Evaluation of Methane Fermentation of Food Waste using TOC and TN Measurement System

The Industrial Research Institute of Shizuoka Prefecture (hereinafter referred to as "IRI Shizuoka Pref.") uses a Shimadzu TOC (Total Organic Carbon) and TN (Total Nitrogen) measurement system for controlling and evaluating methane fermentation of food waste. This Application News introduces the contents of IRI Shizuoka Pref.'s researches.

Y. Ikezawa

### ■ Methane Fermentation

Methane fermentation is a biological process in which microorganisms decompose organic materials such as food waste in the absence of oxygen. Methane gas generated through the process is a renewable energy source and fermentation residue can be used as fertilizer. As shown in Fig. 1, a recycling system will be developed if food processing companies adopt methane fermentation plants.



**Fig. 1 Schematic of Recycling System Utilizing Methane Fermentation**

### ■ Efforts in Shizuoka Prefecture

IRI Shizuoka Pref. is developing a high-efficient and low-cost methane fermentation plant for small-scale food processing companies. In early 2017, a transportable methane fermentation pilot plant with a 1,000 L fermentation tank shown in Fig.2 was developed by industry-academia-government collaboration team. Starting from 2017, the team sets up the pilot plant at various kinds of food processing factories to verify fermentation performance and cost efficiency of each food waste. The test results will be disclosed as model case to encourage other food processing companies to adopt methane fermentation plant in the prefectural area.



**Fig. 2 Transportable Methane Fermentation Pilot Plant**

### ■ Significance of TOC and TN Measurement in Methane Fermentation

Fig.3 shows food waste slurry which is raw material for methane fermentation. Fig. 4 shows methane fermentation residue which is digestion effluent after fermentation. In order to achieve stable methane fermentation, the ratio of carbon and nitrogen (C/N ratio) in the raw material must be within a certain range. IRI Shizuoka Pref. measures TOC and TN of the raw materials to adjust the C/N ratio and to calculate the gas generation efficiency. TOC and TN of the digestion effluents are also measured to calculate the decomposition rate and to evaluate fertilizer components.



**Fig. 3 Food Waste Slurry (Raw material for methane fermentation)**



**Fig. 4 Methane Fermentation Residue (Digestion effluent after methane fermentation)**

#### <Applications of TOC and TN Measurement for methane fermentation>

- Stable fermentation by adjusting the C/N ratio of the raw material
- Evaluation of the gas generation efficiency and the decomposition rate
- TN measurement of the fermentation residue to be used as fertilizer

IRI Shizuoka Pref. uses Shimadzu TOC-L (TOC combustion analyzer) and TNM-L (TN unit) to measure TOC and TN of methane fermentation raw materials and digestion effluents which contain high level of suspended solids. The following introduces the analysis methods and results.

### ■ Analysis Method

In addition to the transportable methane fermentation pilot plant, IRI Shizuoka Pref. has a laboratory-scale methane fermentation test system shown in Fig. 5. Food wastes from food processing companies are tested with the laboratory-scale system and examined whether they can proceed to the pilot plant test or not.



Fig. 5 Laboratory-scale Methane Fermentation Test System

TOC and TN of food waste slurry and digestion effluent are measured using Shimadzu TOC-L and TNM-L shown in Fig. 6 as follows. Firstly, the slurry and effluent are processed with an ultrasonic homogenizer because they contain suspended solids such as small food pieces and microorganisms. Then, they are diluted with ultrapure water and injected into the analyzer. Table 1 shows the measurement conditions.

Table 1 Measurement Conditions

|                    |  |
|--------------------|--|
| Analyzer           | : TOC-LCPH total organic carbon analyzer + TNM-L total nitrogen unit + High Suspension Kit (High concentration)                |
| Catalyst           | : TC/TN catalyst   |
| Measurement item   | : TOC (TC-IC)/TN   |
| Calibration curves | : TC : Single point calibration curve using 200 mgC/L aqueous solution of potassium hydrogen phthalate                         |
|                    | : IC : Single point calibration curve using 100 mgC/L mixed aqueous solution of sodium carbonate and sodium hydrogen carbonate |
|                    | : TN : Single point calibration curve using 100 mgN/L aqueous solution of potassium nitrate                                    |



Fig. 6 TOC-L Total Organic Carbon Analyzer + TNM-L Total Nitrogen Unit

### ■ Analysis Results

Table 2 and Fig. 7 show the analysis results of the raw material and digestion effluent. The decrease in TOC concentration indicates that more than 90 percent of organic materials were decomposed through fermentation. Also, the preservation of TN concentration indicates that nitrogen was maintained through fermentation and the effluents can be used as fertilizer.

Table 2 TOC and TN Measurements of Raw Material and Digestion Effluent

| Sample name                                   | TOC concentration (mg/L) | TN concentration (mg/L) |
|---|--------------------------|-------------------------|
| Raw material for methane fermentation         | 5,445                    | 212                     |
| Digestion effluent after methane fermentation | 374                      | 221                     |

\* The raw material was diluted by a factor of 100 and the digestion effluent was diluted by a factor of 50. Measurement values are converted according to the respective dilution factors.

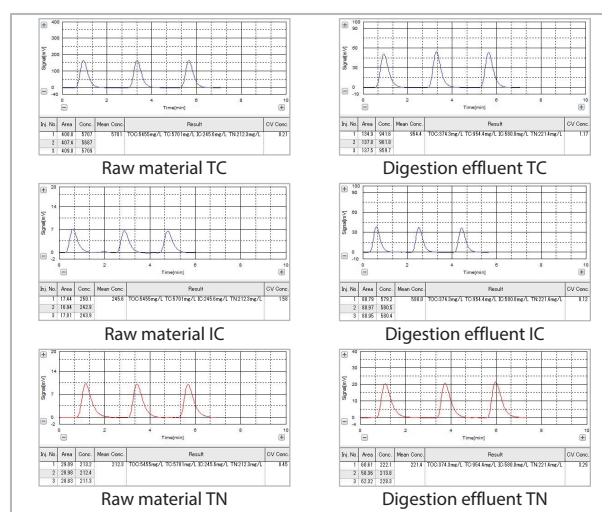


Fig. 7 Analysis Results of Methane Fermentation Raw Material and Digestion Effluent (Left: raw material, Right: digestion effluent)

### ■ Comparison of TOC and Other Method

In the field of methane fermentation research, chemical oxygen demand (COD) is more common to measure the concentration of organic substances in raw materials and digestion effluents than TOC. However, COD measurement is affected by oxidizer, reaction conditions, and the components existing in the analysis sample. On the other hand, since TOC analyzer combusts organic substances and determines the amount of CO<sub>2</sub> automatically, TOC measurement is free from effects described above. Also, Shimadzu TOC-L and TNM-L system can measure not only TOC but also TN which is quite important parameter to control and evaluate methane fermentation.

Methane fermentation research is one of the application which make the best use of Shimadzu TOC and TN measurement system.

Find us on 



Linked 



First Edition: July, 2018



Shimadzu Corporation  
[www.shimadzu.com/an/](http://www.shimadzu.com/an/)

**For Research Use Only. Not for use in diagnostic procedures.**

This publication may contain references to products that are not available in your country. Please contact us to check the availability of these products in your country.

The content of this publication shall not be reproduced, altered or sold for any commercial purpose without the written approval of Shimadzu. Company names, products/service names and logos used in this publication are trademarks and trade names of Shimadzu Corporation, its subsidiaries or its affiliates, whether or not they are used with trademark symbol "TM" or "®".

Third-party trademarks and trade names may be used in this publication to refer to either the entities or their products/services, whether or not they are used with trademark symbol "TM" or "®".

Shimadzu disclaims any proprietary interest in trademarks and trade names other than its own.

The information contained herein is provided to you "as is" without warranty of any kind including without limitation warranties as to its accuracy or completeness. Shimadzu does not assume any responsibility or liability for any damage, whether direct or indirect, relating to the use of this publication. This publication is based upon the information available to Shimadzu on or before the date of publication, and subject to change without notice.

© Shimadzu Corporation, 2018