

# Agilent Hybrid SFC/UHPLC-Triple Quadrupole System for Achiral and Chiral Metabolite Analysis

## Application Note

Pharmaceuticals

### Author

Siji Joseph  
Application Scientist  
Agilent Technologies, Inc.  
Bangalore, India

### Abstract

This Application Note demonstrates the use of an Agilent 1260 Infinity Analytical Hybrid SFC/UHPLC 6460 Triple Quadrupole system for seamless method switching between SFC and RPLC modes for bioanalytical method development. Additionally, we describe a stereospecific assay for the simultaneous achiral and chiral metabolite analysis of warfarin oxidative metabolites using the Agilent 1260 Infinity SFC coupled to an Agilent 6460 Triple Quadrupole LC/MS with sub-nano molar sensitivity for all hydroxywarfarin isomers.

The automated method switching is made possible by including a 2-position/10-port valve, which is controlled by Agilent MassHunter Software without any manual hardware reconfiguration. Using this system in RPLC mode, achiral separation of warfarin and its five hydroxylated metabolites was performed. While in SFC mode, both chiral and achiral separations were performed. The chiral SFC separation method was validated for selectivity, resolution, precision, limit of detection (LOD), and limit of quantitation (LOQ), linearity, and accuracy. The effective use of the method for chiral metabolite profiling was demonstrated by quantifying hydroxylated metabolite enantiomers after 24 hours incubation of racemic warfarin with rat hepatocytes.



**Agilent Technologies**



## Introduction

Metabolite profiling using LC/MS is often made more challenging due to formation of stereo and regio-specific isomers of metabolites. Similarity in the MS/MS fragmentation patterns of isomers can make it more difficult to separate and quantitate isobaric metabolites. Chromatographic separation of individual isomers using both achiral and chiral analysis is the preferable strategy for more confident measurement of these trace level metabolites using mass spectrometry. Reverse phase HPLC is the most preferred separation method for achiral analysis. SFC enables fast separations with several advantages over other conventional normal phase separations for achiral or chiral analysis. The Agilent 1260 Infinity Hybrid SFC/UHPLC system allows seamless automatic method switching between LC or SFC modes for achiral or chiral separation of isomers of metabolites. As an example, the profiling of stereo and regio-isomers of hydroxylated warfarin metabolites is shown in this study.

Warfarin, an anticoagulant, is administered as a racemic mixture and primarily metabolizes into hydroxylated metabolites as indicated in Figure 1<sup>1,2,3</sup>. The 1260 Infinity Hybrid SFC/UHPLC system was coupled with an Agilent 6460 Triple Quadrupole LC/MS for the sensitive quantitation of hydroxylated metabolites. Using this method, stereospecific quantification of metabolites from hepatocyte incubations was also performed.

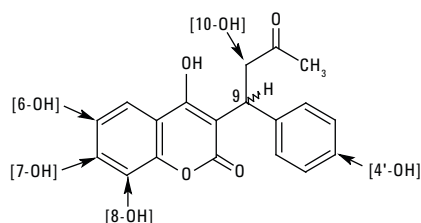

Figure 1. Sites of hydroxylation (4', 6, 7, 8, 9, and 10) on parent drug warfarin.

## Experimental

### Chemicals and reagents

Racemic 4'-, 6-, 7-, 8-, 10-hydroxywarfarin and warfarin were purchased from Sigma-Aldrich (Bangalore, India). Methanol was LC/MS grade, and formic acid was LC/MS eluent additive grade (Sigma-Aldrich, Bangalore, India). Water used in all experiments was demineralized and double-distilled and obtained from Milli-Q Integral Water Purification System (Merck, Darmstadt, Germany). All other chemicals used for the study were purchased from Sigma-Aldrich (Bangalore, India).

### Standard solutions and hepatocyte incubation sample

Individual stock solutions of racemic warfarin and racemic 4'-, 6-, 7-, 8-, 10-hydroxywarfarin were prepared by dissolving the appropriate amount of each in methanol at a 500 ng/mL concentration. Diluted stock solutions of each racemic standard at 20 ng/ $\mu$ L were prepared by diluting the stock solution with methanol. A racemic mixture

containing all analytes at a 2,000 ng/mL concentration was prepared by taking an aliquot of each diluted stock solution and diluting to the desired volume with methanol/water (50/50, v/v). Calibration standards were prepared by serial dilution of 2,000 ng/mL standard mix of racemic mixtures of warfarin and all five hydroxylated metabolites to yield final concentrations of 0.05, 0.1, 0.2, 0.5, 1, 2, 5, 10, 20, 50, 100, 200, 500, and 1,000 ng/mL for each isomeric peak with methanol/water (50/50, v/v). Thus, the corresponding concentrations of each hydroxylated metabolite enantiomer was 0.08, 0.15, 0.31, 0.77, 1.54, 3.08, 7.71, 15.42, 30.83, 77.08, 154.16, 308.33, 770.82, 1,541.64, and 3,083.28 nM. Samples derived from rat hepatocytes incubated for 24 hours with racemic warfarin were generously donated by BMS-Biocon Research Center, Syngene Ltd., Bangalore, India.

## Instrumentation

A 1260 Infinity Analytical SFC system (G4309A) was converted into a Hybrid SFC/UHPLC system by the simple addition of a 2-position/10-port valve, comprising a universal valve drive with a valve head and a second pump (G4220A). The schematic instrument diagram is shown in Figure 2. The system can be run in RPLC mode or in SFC mode by switching the 2-position/10-port valve, which can be programmed as a method parameter. It can also be easily integrated into a sequence. The thermostatted column compartment was equipped with an additional 2-position/6-port column switching valve to enable the selection of the appropriate column for each mode. Including an additional binary pump in the instrument configuration for a make-up flow enhanced the ionization. A flow splitter was also installed prior to injecting the sample in triple quadrupole, by which one part of the column flow was directed to the triple quadrupole and the other part to the backpressure regulator (BPR) of the SFC module. Thus, peak broadening through BPR was avoided.

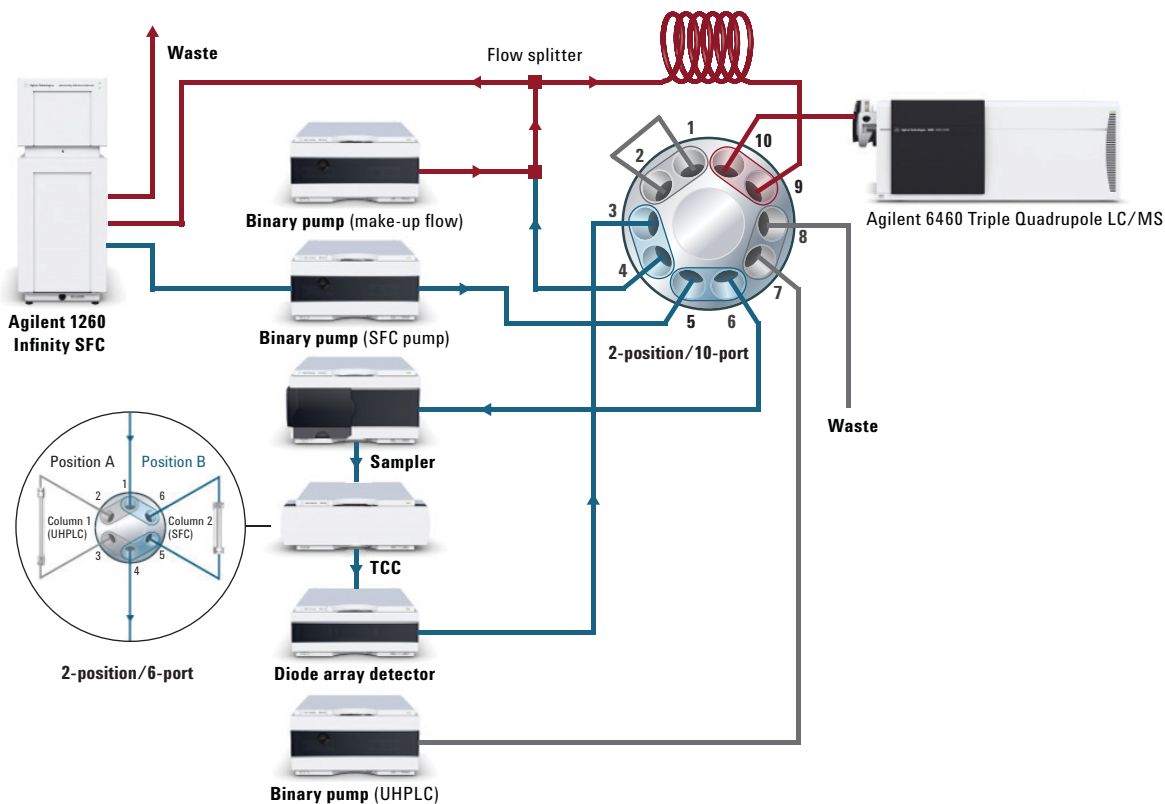

Figure 2. Schematic Instrument Diagram of Agilent 1260 Infinity Hybrid SFC/UHPLC system.

## Instruments

Agilent 1260 Infinity Analytical SFC Solution (G4309A) comprises:

- Agilent 1260 Infinity SFC Control Module
- Agilent 1260 Infinity SFC Binary Pump
- Agilent 1260 Infinity High Performance Degasser
- Agilent 1260 Infinity SFC Standard Autosampler
- Agilent 1260 Infinity DAD with high pressure SFC flow cell
- Agilent 1290 Infinity Thermostatted Column Compartments (TCC) with valve drive

For UHPLC to convert the SFC system to a Agilent 1260 Infinity Hybrid SFC/UHPLC system, the following modules are required:

- Agilent 1290 Infinity Binary Pump (G4220A)
- SFC/UHPLC Hybrid Capillary Kit

For MS analysis and connection the following modules are required:

- Splitter kit (p/n G4309-68715)
- Agilent 1260 Infinity Isocratic Pump (G1310B)
- Agilent 6460 Triple Quadrupole LC/MS System (G6460A)

## Experimental Conditions

The method parameters used in the achiral/chiral separation of warfarin and its five hydroxylated metabolites in RPLC and SFC mode are listed in Table 1. The achiral RPLC separation was achieved using the LC mode of the Hybrid instrument configuration on an Agilent 1290 Infinity Binary LC system equipped with a binary pump, a thermostatted autosampler, and a thermostatted column oven. An Agilent ZORBAX Eclipse Plus Phenyl Hexyl column was used for RPLC. The achiral/chiral SFC separations were achieved using the SFC mode of the Hybrid instrument configuration. The

achiral SFC separation was achieved with an Agilent ZORBAX RX-SIL column. For chiral SFC analysis, a CHIRALPAK OD-3 column was used.

The analytes from the RPLC and SFC separations were detected using an Agilent 6460 Triple Quadrupole Mass Spectrometer. The electrospray source was equipped with Agilent Jet Stream (AJS) thermal gradient focusing technology to enhance sensitivity, and was operated in positive mode. Optimized electrospray ion source parameters were 30 psi for the nebulizer gas and 7 L/min for the drying gas, with a temperature of 275 °C.

The AJS sheath gas flow was 10 L/min at 325 °C. The source voltage conditions were: nozzle voltage at 500 V, capillary voltage at 3,000 V, fragmentor voltage at 130 V, and collision energy at 12 V. Protonated  $[M+H]^+$  ions of warfarin and its metabolites were selected as precursors for MRM acquisition. The quantifier and qualifier MRM transitions are shown in Table 2. Agilent MassHunter Workstation (Version: B.06.00) Software was used for the triple quadrupole acquisition. The MassHunter Qualitative and Quantitative Analysis Software (Version: B.07.00) were used for further data analysis.

Table 1. RPLC and SFC method parameters.

Parameters	RPLC	SFC (BPR: Pressure;140 bar, Temp; 60 °C)
Mobile phases	A) 0.05 %FA in water B) 0.05 %FA in Methanol with 5 mM Ammonium formate	A) CO <sub>2</sub> B) 0.1 % formic acid in methanol with 5 mM Ammonium formate
Make up flow	NA	B) 0.1 %Formic acid in Methanol with 5 mM Ammonium formate at 0.3 mL/min
Column	Agilent ZORBAX Eclipse Plus Phenyl Hexyl, 2.1 × 150 mm, 1.8 μm Column at 25 °C	<b>Achiral analysis</b> Agilent ZORBAX RX-SIL, 4.6 × 150 mm, 5 μm at 48 °C <b>Chiral analysis</b> CHIRALPAK OD-3, 3.0 × 100 mm, 3 μm at 48 °C
Injection volume	Partial loop 1 μL	Full loop 5 μL (overflow factor 3)
Needle wash	Methanol	Methanol
Flow rate	0.4 mL/min (Agilent 1290 Infinity Binary Pump)	3 mL/min (Agilent 1260 Infinity Binary SFC Binary Pump)
Gradient	Time (min) % B 0 35 9 75 10 98 12 98 12.5 30 15 35	Time (min) % B 0 8 10 18 10.5 8 12 8
Post run	1 minute	1 minute

Table 2. Quantifier and qualifier MRMs used for the triple quadrupole settings.

Compound	Precursor	Product ion
<b>Quantifiers</b>		
4'-OH Warfarin	325	163
6-, 7-, and 8-OH Warfarin	325	179
10-OH Warfarin	325	251
Warfarin	309	163
<b>Qualifiers</b>		
4'-, 6-, 7-, and 8-OH Warfarin	325	267
10-OH Warfarin	325	163
Warfarin	309	251

## Procedure

A standard mix of warfarin and five hydroxyl metabolites at a 100 ng/mL concentration was used to develop RPLC and SFC methods. All linearity levels were analyzed using the SFC chiral method in 10 replicates, and method validation parameters such as selectivity, limit of detection (LOD), and limit of quantitation (LOQ) precision were evaluated. Calibration curves were obtained by plotting the peak area of the respective enantiomer to the corresponding concentrations of enantiomers. Accuracy values of each linearity level were calculated from the linearity equation. The metabolites from the hepatocyte incubation sample were identified and quantified based on MRM data of known standards.

## Results and Discussion

### Method development

Achiral reverse phase analysis using a narrow bore phenyl hexyl column showed excellent base line separation of warfarin and all five hydroxylated metabolites under gradient conditions described in the experimental section (Figure 3). The achiral SFC analysis, using a ZORBAX RX-SIL column, also resulted in a clear separation of warfarin and all five hydroxyl metabolites (Figure 4). The process of switching between RPLC and SFC methods was easy with the help of the 2-position/10-port valve<sup>4</sup>. The complementarity between RPLC and SFC analysis is evident from the reversal of elution order of warfarin and metabolites. SFC offers a faster analysis time compared to RPLC.

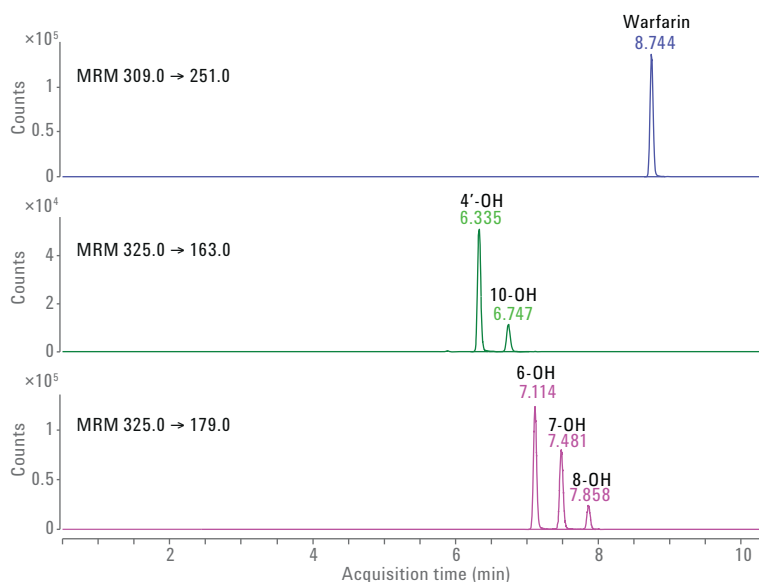

Figure 3. Achiral separation using RPLC (MRM Transition of metabolites are shown).

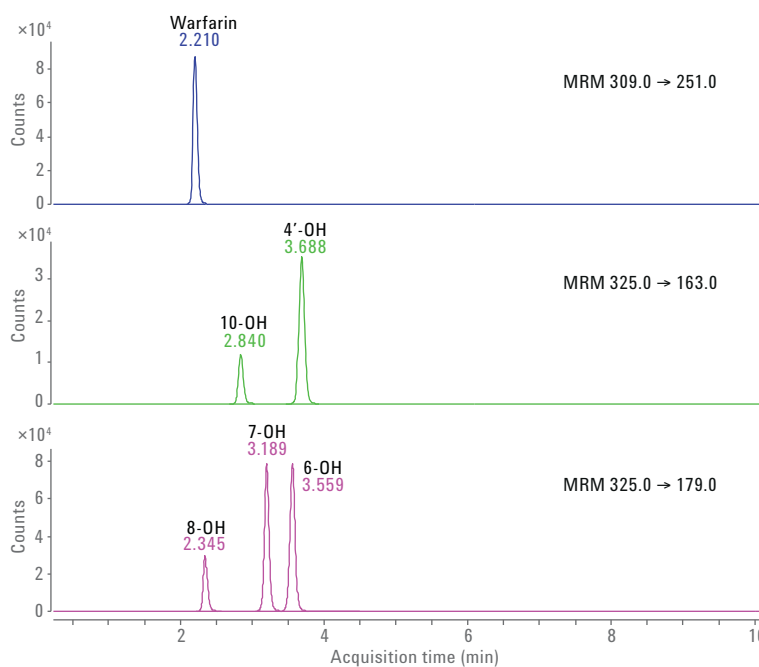

Figure 4. Achiral separation using SFC (MRM transition of metabolites are shown).

Chiral SFC analysis using a CHIRALPAK OD-3 column was able to separate the enantiomers of all five regio- and stereoisomers of hydroxyl warfarin. However, baseline separation of few isomeric peaks were compromised (Figure 5A). A serial connection of ZORBAX RX-SIL and CHIRALPAK OD-3 columns in SFC mode was able to resolve the enantiomers of all five hydroxywarfarin regio-isomers, as well

as parent warfarin (Figure 5B). The low column backpressure (< 260 bar) in SFC mode offers greater flexibility to couple multiple column chemistries and add orthogonality in the separation. The total chromatographic separation time for the stereospecific profiling of warfarin and hydroxylated metabolites was less than 8 minutes using the SFC/triple quadrupole method.

Thus, by using the Agilent 1260 Infinity Hybrid LC/SFC system, method development for the identification and quantitation of oxidative warfarin metabolites was greatly simplified, and the chromatographic orthogonality helped in arriving at the best possible bioanalytical method to attain stereospecific resolution of metabolites as well as optimizing sensitivity of measurement.

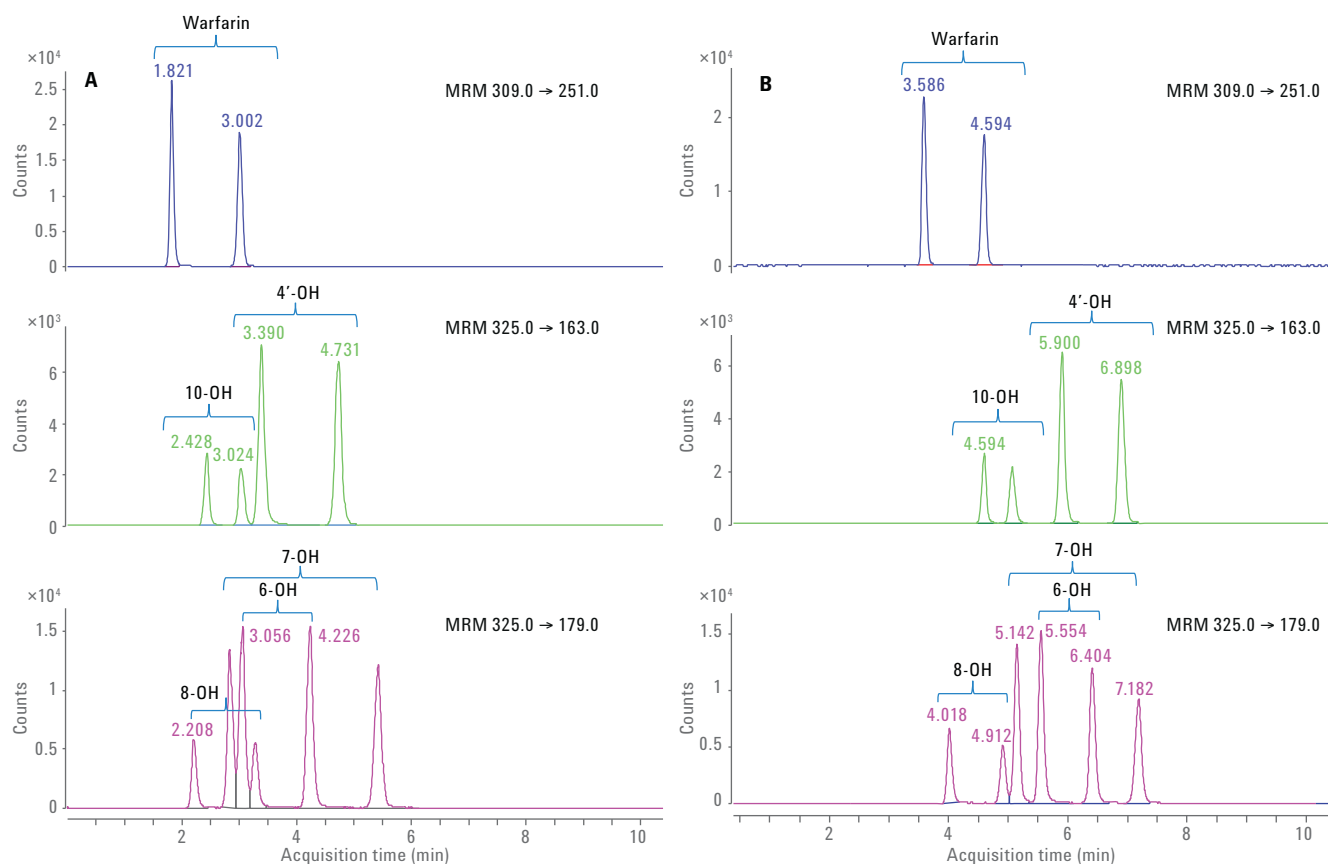

Figure 5. A) Chiral separation of 100 ng/mL standard mix in SFC mode using a CHIRALPAK OD-3 column. Isomers of each metabolites are marked. B) Improved chiral SFC separation of the standard mix, when an Agilent ZORBAX RX-SIL column was serially connected with a CHIRALPAK OD-3 column. MRM transitions for all metabolites and warfarin are labelled. The separation of 6-, 7-, and 8-hydroxy warfarin isomers was significantly improved when a ZORBAX RX-SIL column was serially connected with a CHIRALPAK OD-3 column.

### Evaluating reproducibility of stereospecific SFC/Triple Quadrupole method

As described previously, a SFC chiral method employing the serial connection of ZORBAX RX-SIL and CHIRALPAK OD-3 columns was selected for the quantitative analysis since this method was able to baseline resolve all the hydroxylated warfarin metabolite enantiomers. The validation criteria used were method selectivity, detection limits and linearity ranges of each metabolite, precision, and accuracy. To assess the selectivity of the developed method, the target MRM transition was compared with that of a blank trace, and no interfering peaks were observed. The lowest concentration of each metabolite peak with a signal-to-noise (S/N) ratio of at least 10:1 was recorded as the LOQ, and with a S/N ratio of 3:1 as the LOD. As an example, the MRM transition 325.0 → 179.0 trace for the blank and standard mix at 0.15 nM concentration is shown in Figure 6, where 8-OH warfarin is at LOD level, and 6- and 7-OH warfarin is at LOQ level.

A linearity curve for each metabolite was plotted using the peak area and the calculated concentration of the studied concentration range. To determine the best linearity response function, various regression models were evaluated, and the best calibration model was determined to be a quadratic curve using a  $1/x^2$  weighting. The method validation results for LOD, LOQ, and linearity are summarized in Table 3.

Precision was determined by measuring relative standard deviation (RSD) of retention time (RT) and peak area on repeat injections. Excellent retention time and peak area precision values were observed for all metabolites throughout the linearity range. The RT RSD is less than 0.2 % for all levels. The peak area RSD for all levels except for LOQ was less than 5.0 %, and for LOQ the peak area RSD value was less than 10 %. Accuracy values of each of the linearity levels were calculated from the observed linearity equation, and were well within  $100 \pm 10$  %.

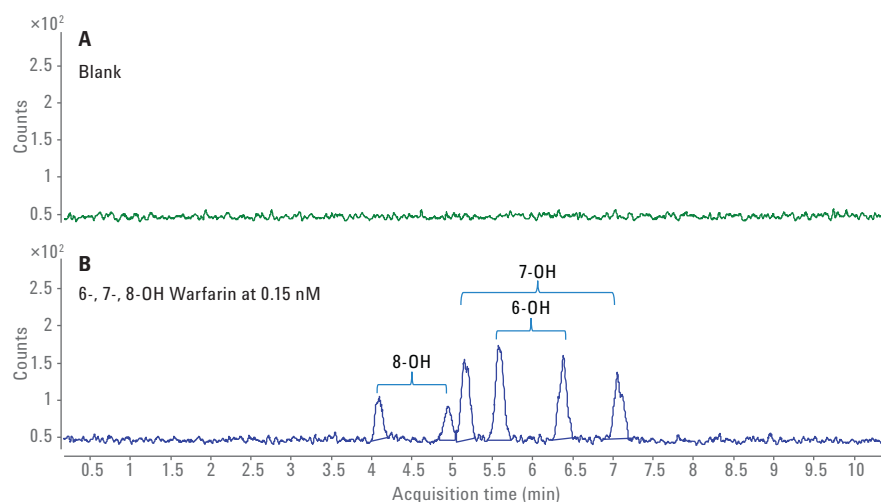

Figure 6. MRM transition 325.0 → 179.0 trace for blank (A) and standard mix at 0.15 nM concentration (B). In B, 8-OH warfarin enantiomers are at LOD level, and 6- and 7-OH warfarin enantiomers are at LOQ level.

Table 3. The method validation results for LOD, LOQ, and linearity.

Validation parameter	Warfarin		4'-OH		6-OH		7-OH		8-OH		10-OH	
	Isomer 1	Isomer 2	Isomer 1	Isomer 2	Isomer 1	Isomer 2	Isomer 1	Isomer 2	Isomer 1	Isomer 2	Isomer 1	Isomer 2
LOD (nM)	0.08	0.08	0.15	0.15	0.08	0.08	0.08	0.08	0.15	0.15	0.15	0.15
LOQ (nM)	0.16	0.16	0.31	0.31	0.15	0.15	0.15	0.15	0.31	0.31	0.31	0.31
Linear range (nM)	0.16–3243	0.16–3243	0.31–3083	0.31–3083	0.15–3083	0.15–3083	0.15–3083	0.15–3083	0.31–3083	0.31–3083	0.31–3083	0.31–3083
Correlation coefficient, R <sup>2</sup>	0.99	0.99	0.99	0.99	0.99	0.99	0.99	0.99	0.99	0.99	0.99	0.99

## Analysis of warfarin incubations with rat hepatocytes

The above described chiral SFC-Triple Quadrupole method was used for analyzing plated rat hepatocyte incubations with racemic warfarin and calculated metabolite concentrations (Figure 7). In this experiment, significant levels of most hydroxywarfarin metabolites were observed including 4'-, 6- and 7-hydroxywarfarin, along with low levels of 10-hydroxywarfarin.

## Conclusions

This Application Note has demonstrated the use of an Agilent hybrid UHPLC/SFC-Triple Quadrupole system that is capable of switching between HPLC and SFC modes. Using HPLC or SFC modes allows achiral separation of warfarin and its five hydroxylated metabolites. Enantiomers of each hydroxylated metabolite were unequivocally separated by chiral SFC analysis. The SFC chiral method was partially validated and found to be linear over four orders of magnitude with an LOD below 0.15 nM and an LOQ below 0.3 nM for all of the metabolites. Automatic switching between RPLC and SFC modes using an Agilent Hybrid UHPLC/SFC-Triple Quadrupole offers the instrument flexibility needed for achiral and chiral drug metabolism studies.

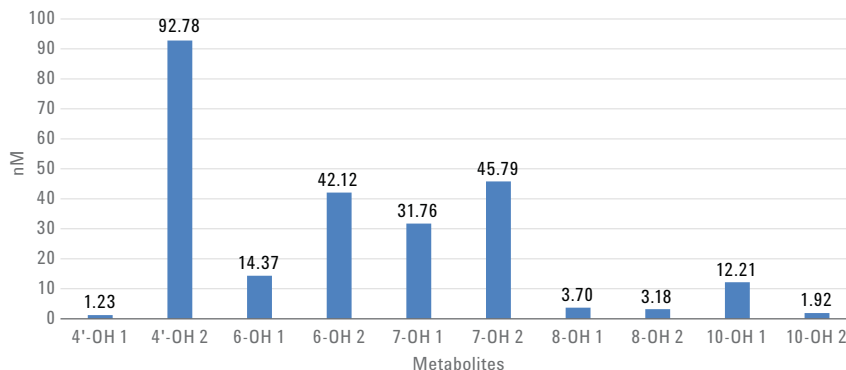

Figure 7. Formation of hydroxylated warfarin metabolites from hepatocytes Incubation after 24 hours.

## References

1. Jones, D. R; Miller, G. P. Assays and applications in warfarin metabolism: what we know, how we know it and what we need to know, *Expert Opin. Drug Metab. Toxicol.* **2011**, 7(7), pp 857-874.
2. Kaminsky, L. S; Zhang, Z. Y. Human P450 metabolism of warfarin. *Pharmacol. Ther.* **1997**, 73, pp 67-74.
3. Jones, D; Moran, J. H; Miller, G. P. Warfarin and UDP-glucuronosyltransferases: writing a new chapter of metabolism. *Drug Metab. Rev.* **2010**, 42, pp 55-61.
4. Agilent 1260 Infinity Analytical Hybrid SFC/UHPLC system, *Agilent User Manual*, part number G4309- 90121.

## Acknowledgement

We thank Dr. Murali Subramanian, BMS-Biocon Research Center, Syngene Ltd., Bangalore, India for his immense support for generously providing us hepatocyte incubated samples.

[www.agilent.com/chem](http://www.agilent.com/chem)

This information is subject to change without notice.

© Agilent Technologies, Inc., 2015  
Published in the USA, May 1, 2015  
5991-5725EN



Agilent Technologies