

Atomic Absorption Spectrometers Productive, Precise, Reliable.

Agilent 200 series AA systems

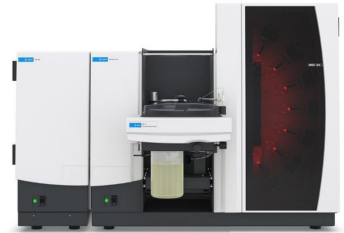
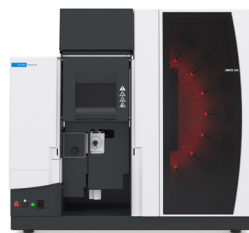
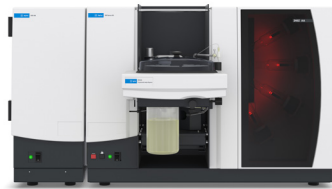
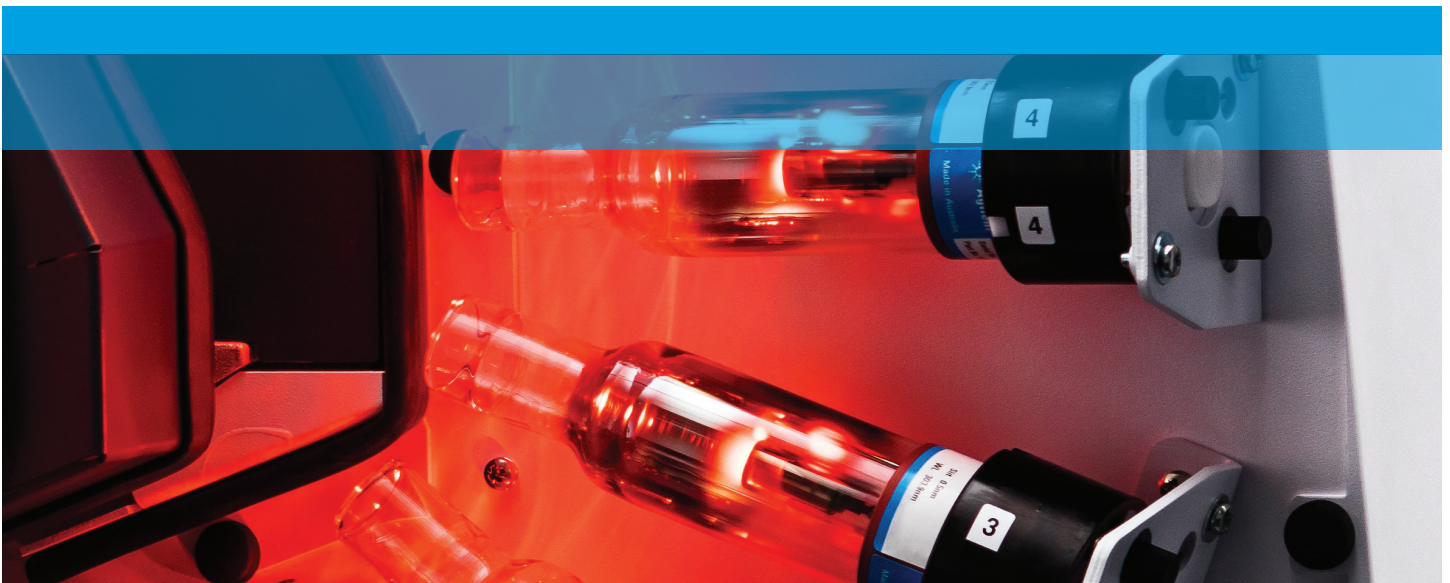

Productive, Precise, Reliable.

Agilent's AA range is productive, user-friendly, and exceptionally reliable. The instruments deliver the high performance that analysts require, while being equally at home in routine laboratories where reliability and simple operation are vital.



The **Agilent 240 FS** is designed for routine flame/vapor analyses for budget-sensitive labs. The instrument features Agilent's unique Fast Sequential mode, which significantly improves analysis productivity, handling multi-elemental analysis with ease. The 240 FS has four lamps and is well suited for routine analysis.

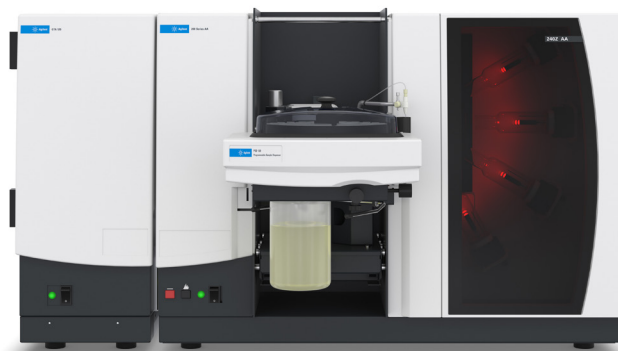

The **Agilent 240Z Zeeman Graphite Furnace AA (GFAA)** with Transverse Zeeman background correction provides the most uniform and accurate correction for even your toughest samples. It features four lamps and is suitable for all routine trace level analyses, with software tools to simplify your analysis.

Which instrument will suit your application?

	Environmental	Food and Agriculture	Chemical and Petrochemical	Materials and Mining	Pharmaceutical
FS Flame AA 240FS + SIPS, 280FS + SIPS	Determination of Mg, Ca, and K in brines (SIPS accessory provides automated calibration and online sample dilution) Analysis of Cr in soils and solid wastes	Major elements Ca, Cu, Fe, Mg, Na and Zn in food, beverage, and agricultural samples Cations and nutrients in soils	Na and K in FAME (fatty acid methyl esters) Pb and Mn in unleaded gasoline	Ca, Cr, Cu, Fe, K, Mg, and Na in plating solutions Au, Ag, and Pt group elements in ore grade material	Cu in traditional Chinese medicines
Vapor Generation AA 240FS/280FS AA + VGA 77	As, Hg, and Sb in coal fly ash As, Sb, and Se in sediments Hg in waters, effluent, etc. (US EPA method 245.1)	Hg and As in fish and sea foods Trace As and Sb levels in plant materials		Hg in electronics and plastics (WEEE/RoHs) As and Sb in zinc plating solutions	Hg and As in raw materials used in the production of pharmaceutical components
Zeeman GFAA 240Z AA, 280Z AA	Toxic elements in waters (GB/T 5750, US EPA method 200.9.) Toxic and Heavy metals Be, Pb and Cd in soils and sediments (HJ and GB/T Methods) Cd, Cu, Pb, Co, and Ni in marine invertebrates	Pb in soy sauce following GB 2762 Pb and Cd in fish, sea foods, and plant Determination of Cd, Cr, Ni and Pb in Grains Cu, Fe, and Ni in edible oils	Ni, V, Fe, and Na in crude oils Trace elements in heavy, industrial fuel oils Trace elements in high purity sulfuric acid or Na, Ca, and Si in pure process water	Al and Fe in paper Pb and Cd in consumer goods, toys, jewelry Pb, Cd, and Cr in electronics and plastics (WEEE/RoHs) Trace metals in high purity copper	Analysis of Cd, and Pb impurities in pharmaceutical substances

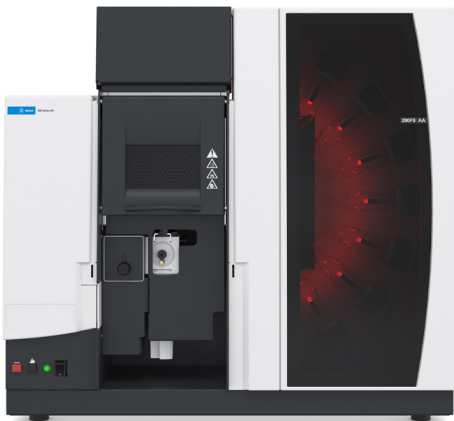

The **Agilent 280FS** is a high performance flame atomic absorption spectrometer. It combines eight lamps with Agilent's patented Fast Sequential mode, doubling sample throughput and dramatically reducing running costs. The 280FS has high performance optics and is ideal for high throughput labs wanting the best performance.

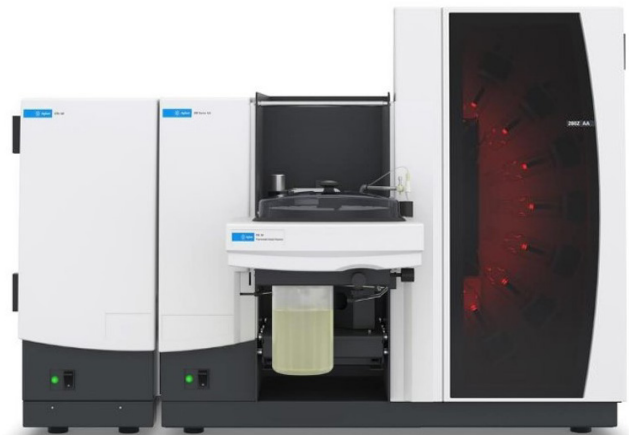

The **Agilent 280Z GFAA** features Transverse Zeeman background correction, a high specification optical system, and eight lamps. The instrument is designed for laboratories needing the lowest detection limits.

The **Agilent Duo system** features two instruments: one flame AA and one graphite furnace AA, controlled by one computer. This system is ideal for labs that need to be ready for any sample type and that want to avoid the lost productivity associated with swapping between flame and furnace operation on one instrument.

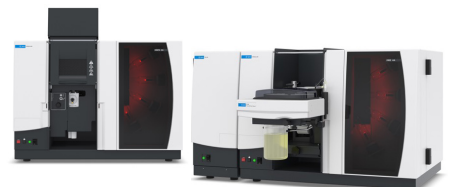

Fast Sequential Flame AA

Achieve the productivity and speed of sequential ICP with Agilent's Proven and Reliable 240FS and 280FS Fast Sequential (FS) AA systems.

Fast Sequential mode will:

Boost productivity and slash running costs

- Determine the concentration of all elements from a single aspiration of each sample
- Halve your analysis time by reducing sample analysis delays
- Reduce sample consumption—with less delay throughout analysis and less sample waste
- Save labor and reduce running costs—the more elements you determine, the more you save on gas, reagents, and lamps
- Further analysis time reduction when combined with PROMT acquisition mode. By setting the desired precision limits, elements with higher concentrations are determined quickly

Get accurate results

- Determine 10 elements per sample in less than 2 minutes without compromising data quality
- Provide full elemental coverage, with freedom to analyze extra elements without the significant time penalty of conventional AA
- Improve precision and accuracy with online internal standard corrections for physical differences, sample preparation errors, or drift

Simplify your analysis

- Take the guess work out of method development with SpectrAA's comprehensive cookbook
- Easily set up FS methods and accelerate method development with the FS wizard
- Minimize re-runs and automate analysis with the Sample Introduction Pump System (SIPS) accessory, simplifying sample preparation by performing automatic dilutions, calibrations, and inline additions and spikes

Time and gas savings with Fast Sequential Flame AA

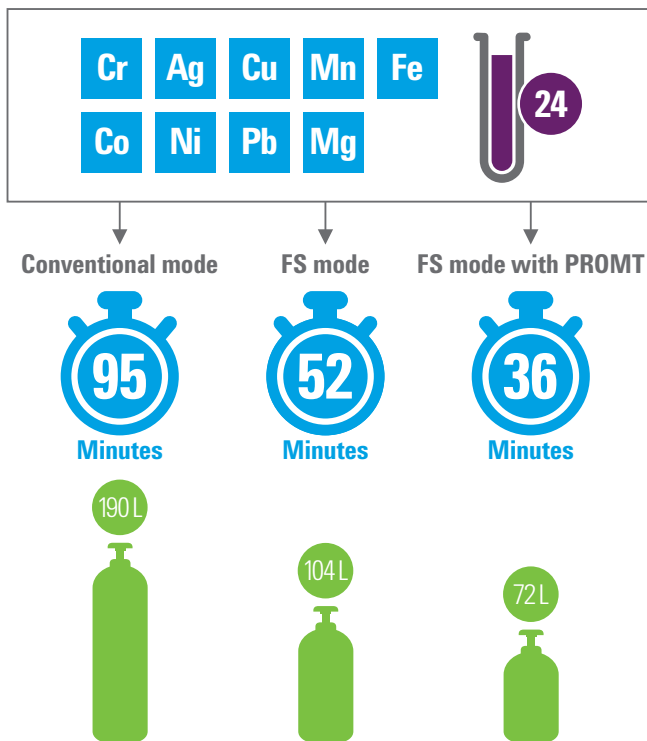

Nine elements in 24 samples were quantified in three different ways: Conventional FAAS mode (3 integrations of 3 seconds for each element), Fast Sequential mode, and Fast Sequential mode with PROMT acquisition. The analysis used an autosampler, included a Calibration Zero and three standards. A 5 s rinse was performed every 10 samples.

Fast Sequential vs Conventional AA

Fast Sequential mode

Using Fast Sequential mode, samples are only aspirated once, with all elements being measured before the next sample is aspirated.

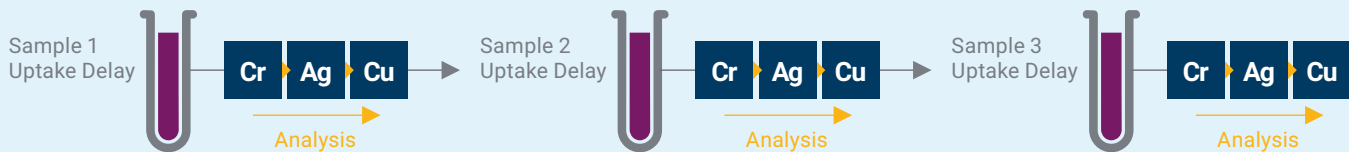

Conventional mode

Conventional AA determines only one element from each sample aspiration, so samples are analyzed time and time again during a multi-element sequence.

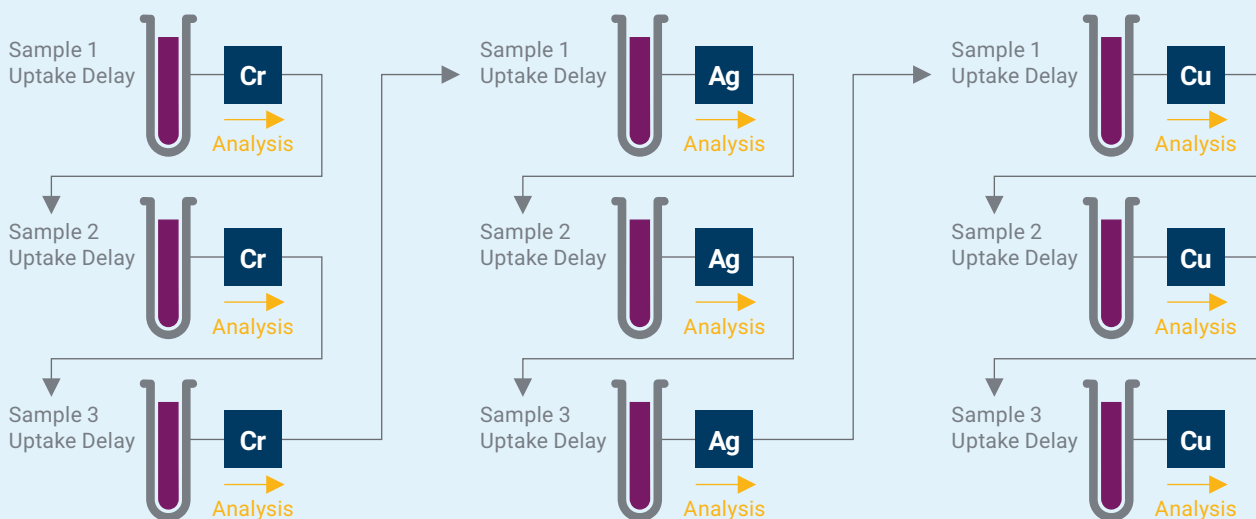

Achieve high-speed Flame AA without compromising precision

Precision Optimized Measurement Time (PROMT) optimizes measurement time to match the operators target level of precision (%RSD). PROMT reduces analysis time as a function of analyte concentration without compromising precision.

PROMT mode offers:

- Increased productivity
- Reduced gas consumption, resulting in lower running costs
- When combined with Fast Sequential mode, gas consumption and analysis time reduced by over 60%

Sensitive and Accurate Furnace AA

The Agilent 240Z AA and 280Z AA with Zeeman background correction provides the furnace performance and background correction accuracy required to measure ppb levels of toxic, heavy metals such as Pb and Cd.

Zeeman dedicated GFAA

Environmental agencies (such as the US EPA) accept Zeeman background correction as the most effective background correction technique for regulated environmental analyses.

The Agilent 240Z AA and 280Z AA feature powerful transverse Zeeman background correction over the full wavelength range for structured backgrounds, spectral interferences, and high background absorbances.

High sensitivity and freedom from interference for challenging samples

- Outstanding performance at ppb levels from the constant temperature zone (CTZ) furnace design that features long, end-heated atomization tubes that are uniformly heated, allowing for rapid and effective heating leading to fast, productive sample analysis
- High correction accuracy with Agilent's unique magnetic waveform providing background correction at double the speed of longitudinal Zeeman systems, featuring three point polynomial interpolation for an 11-fold improvement in accuracy

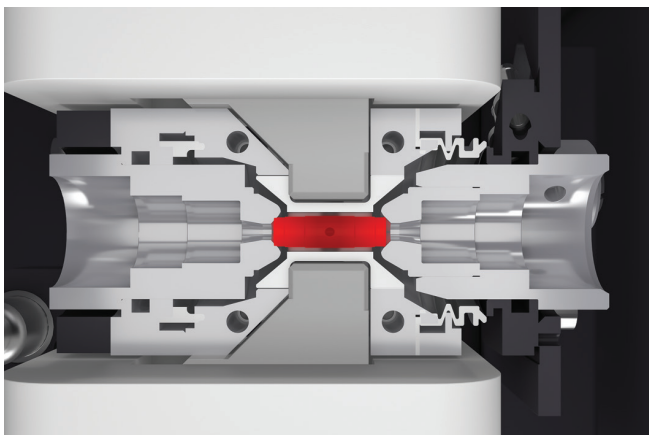

The Agilent Zeeman systems feature the transverse Zeeman configuration and constant temperature zone furnace design.

High sensitivity and accurate background correction for your toughest samples

Agilent Zeeman systems feature the transverse AC modulated Zeeman configuration with the field applied across the atomizer for the most effective and uniform background correction.

Light throughput is maximized in the 240Z and 280Z compared with compromised longitudinal designs that utilise short, end-capped tubes that restrict the light passing through the pole pieces of the magnet. Maximizing the light ensures outstanding sensitivity and maximum performance with challenging sample matrices.

Linear Interpolation Procedure

Background to be calculated at this 'magnet off' measurement

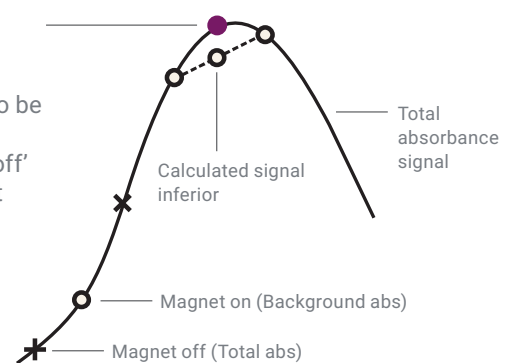

Polynomial Interpolation Procedure

Background to be calculated at this 'magnet off' measurement

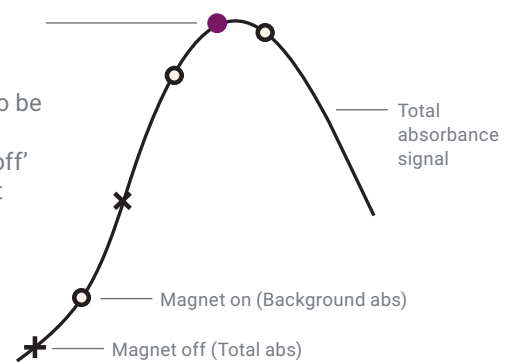

Agilent Zeeman systems use three point polynomial interpolations to accurately track the background signal, resulting in an 11-fold improvement in correction accuracy.

Automate furnace AA method development

Method development for the Agilent 280Z furnace AA is automated with the surface response methodology (SRM) wizard.

Good method development is critical to ensure the best performance in GFAAS. The unique Agilent SRM Wizard finds the optimum relationship between furnace ash temperature, atomization temperature, and analyte absorbance. It then automatically creates a method. Method development time is significantly reduced by avoiding the 'one variable at a time' approach taken by other vendors.

The SRM Wizard is also a useful tool in comparing and selecting the best chemical modifier to use for an analyte in a particular sample.

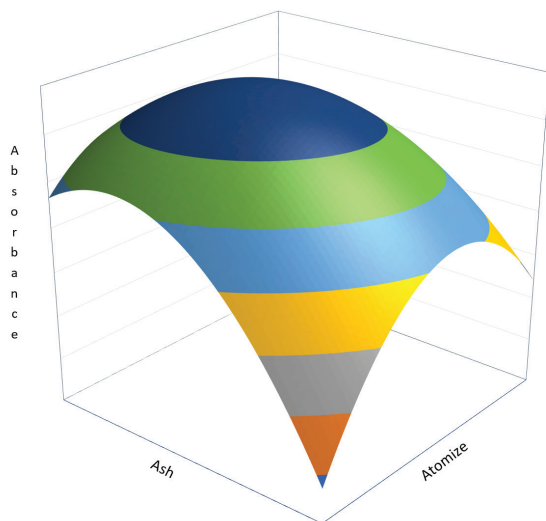

Surface Response plots using the SRM Wizard can be used to create and evaluate methods for different samples.

Simple setup and operation

- The PSD120 furnace autosampler (with capacity for up to 130 solutions), automatically prepares and delivers calibration standards from a single bulk standard. The autosampler also provides calibration through standard addition.

The PSD120 provides flexible dispensing options including hot injects, multiple injects, and addition of chemical modifiers.

The PSD120 can prepare and inject a lower volume of a sample in response to an over-range measurement.

- The Tube-CAM video monitoring lets you see inside the graphite tube, in real time. Using this view you can determine critical parameters such as the drying and ashing conditions, and the dispensing height.
- The Surface Response Methodology (SRM) furnace optimization software wizard simplifies method development, enabling you to easily select optimum conditions for your analysis.
- Easy alignment—only a single light source is required.

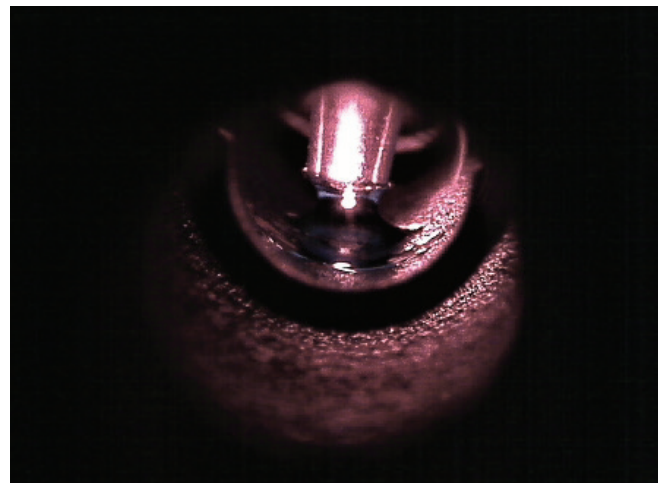

Tube-CAM simplifies method development and enables you to set the dispensing height and monitor the analysis.



The Duo—simultaneous flame and furnace

The Agilent range of Duo systems offer simultaneous flame and furnace operation that delivers the lowest cost per analysis, making it ideal for busy laboratories.

- Double the productivity of your laboratory—an Agilent AA Duo provides true simultaneous operation of flame and graphite furnace from a central computer
- Save time with dedicated atomizers that eliminate complex setup and time consuming changeovers. Each atomizer is permanently aligned for immediate use and never needs re-alignment
- Analyze any sample, with the widest linear dynamic range from sub ppb (using furnace and hydride techniques) to percent levels (flame)
- User-friendly software delivers rapid instrument setup, easy operation, and simple method development

Increase sensitivity by up to 40% with UltrAA Lamps

UltrAA lamps lower detection limits for the most demanding flame, furnace and vapor AA applications.

Benefits of the UltrAA lamp

- Increased sensitivity. The sharper emission profile of the UltrAA lamp reduces self-absorption and line broadening, enhancing sensitivity by up to 40%
- Reduced baseline noise, due to the higher emission intensity
- Lower detection limits, resulting from the improved signal-to-noise performance.
- Enhanced calibration linearity
- Long lamp lifetimes for economical operation. Typical lifetimes exceed 8000 mA hours of operation
- Simple installation—lamps mount directly into the socket, just like conventional lamps
- Agilent Zeeman AA systems feature an integrated lamp control module

Software to Simplify Your Analysis

User-friendly software with all instrument controls, sample results, and signal graphics accessible from one window.

Simple method development

- Be guided through every aspect of analysis. Guidance includes setting up a Fast Sequential sequence or creating custom racks and layouts for use with the SPS 4 autosampler
- Automate furnace optimization with the Surface Response Methodology (SRM) wizard. This wizard recommends the optimum parameters and automatically creates a method using these conditions

Run an urgent sample

- Got an urgent sample to run? Simply click the 'Random Sample' option to run it immediately. When complete, the system will resume the programmed sequence

Powerful reporting options

- Select which data to include and the report type, including sequential or multi-element formats
- Directly import and export to the LIMS online, eliminating tiresome and error-prone manual transfers

Track consumables use

- Save on downtime and running costs by tracking the operating lifetime of key consumables such as lamps, electrodes, and pump tubing. You can also track how many replicates or samples have been run to help anticipate consumable replacement

Compliance support for regulated industries

- Ensure full compliance with US EPA requirements by confirming your results during analysis with a comprehensive range of QC tests
- Instrument qualification services (IQ/OQ) provide initial and ongoing verification that your system meets regulatory requirements

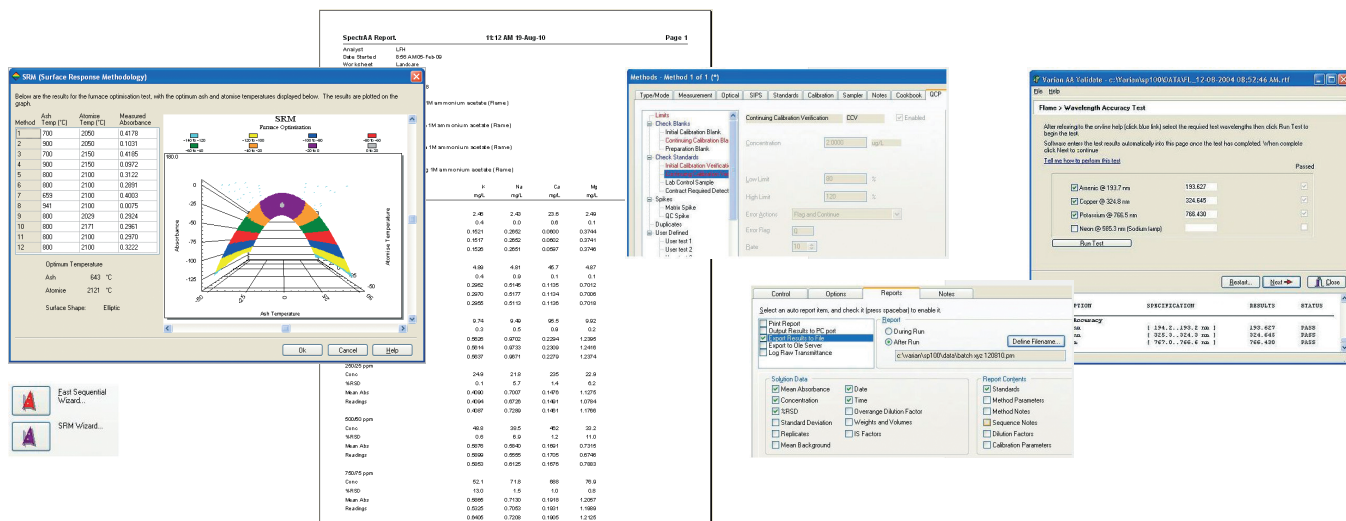

Guide > Report > Validate > Integrate > Certify >

Accessories to Meet Your Analysis Challenges

With an extensive range of accessories to extend the capabilities of Agilent AA instruments, you can meet all your analysis challenges.



Automatic dilutions, calibrations, and inline additions and spikes

The Sample Introduction Pump System (SIPS) improves productivity by automatically preparing calibration standards and reduce sample remeasurement by performing over-range dilutions up to 200x with less than 2% error. For further details refer to the SIPS Overview, publication number 5991-6613EN

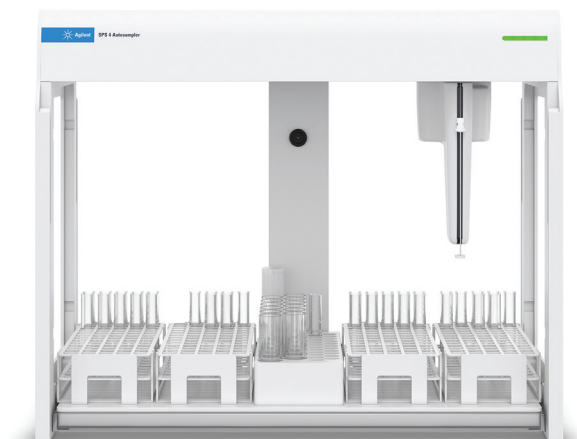

Fast and flexible autosampler

Automate your analysis with the Agilent SPS 4 high-performance autosampler. Designed to meet the needs of laboratories requiring a fast, high capacity and reliable autosampler, it is also small, quiet, easy-to-use and robust for flame AA analysis. For further details refer to the SPS 4 flyer, publication number 5991-5730EN



Hydride analysis

The Vapor Generation Accessory (VGA 77) is well suited to cost-conscious environmental, food, and agriculture laboratories. It offers trace level determination of Hg using the regulatory approved cold vapor technique, or for hydride forming elements such as As and Se using the vapor generation technique. For further details refer to the VGA Overview, publication number 5990-6710EN

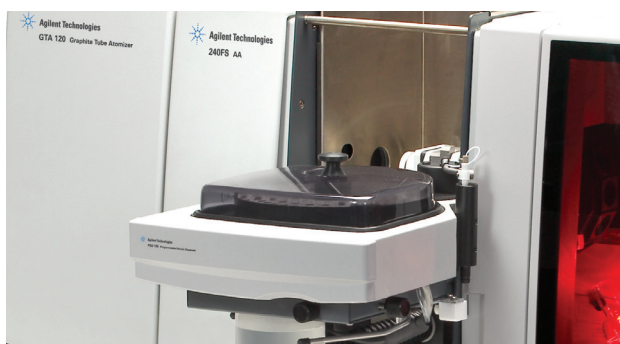

Graphite furnace

The integrated GTA 120 Graphite Tube Atomizer provides superior furnace performance, no matter how difficult the sample, making it ideal for applications as diverse as chemical, petrochemical, food, and agriculture. The 240FS and 280FS can be optioned with the GTA120 to add for furnace capability. For further details refer to the GTA120 Overview, publication number 5991-6667EN

Tune your flame AA performance

The Agilent Mark 7 atomization system is supplied as standard with the 280 FS AA instruments. It can:

- Achieve high sensitivity—typically > 0.9 Abs. from 5 mg/L Cu
- Optimize precision—typically < 0.5% RSD from ten 5 second integrations
- Reduce interferences for complex samples with removable twin headed mixing paddles
- Minimize burner blockage with a contoured burner design
- Corrosion resistant components provide increased durability making it ideal for high acid matrices

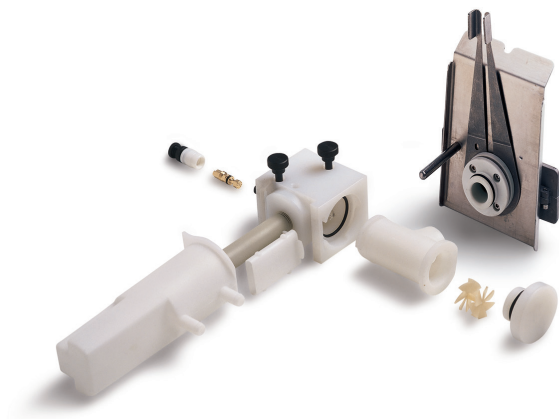

Services and Supplies

Maximize your productivity and data quality with genuine Agilent atomic spectroscopy supplies.

Your essential resource for supplies

Agilent AA supplies are manufactured to stringent specifications and rigorously tested to ensure you can optimize performance. Agilent offers an extensive range of single-element and solid cathode multi-element lamps, and high intensity UltrAA lamps for superior, cost effective performance. Why risk compromising your analytical result with anything else?

For more information, see www.agilent.com/chem/specsuppliesinfo



Our services let you focus on what you do best

Whether you need support for a single instrument or multiple labs, Agilent can help you solve problems quickly, increase uptime, and maximize the productivity of your team with:

- Onsite maintenance, repair, and compliance
- Service agreements for all your systems and peripherals
- Application training and consulting from our dedicated, worldwide network of specialists

Agilent Service Guarantee

If your Agilent instrument requires service while covered by an Agilent service agreement, we guarantee repair or we will replace your instrument for free. No other manufacturer or service provider offers this level of commitment to keeping your lab running at maximum productivity.

Agilent CrossLab: Real insight, real outcomes

CrossLab goes beyond instrumentation to bring you services, consumables, and lab-wide resource management. So your lab can improve efficiency, optimize operations, increase instrument uptime, develop user skill, and more.



Learn more:

www.agilent.com/chem/

Buy online:

www.agilent.com/chem/store

Get answers to your technical questions and access resources in the Agilent Community:

community.agilent.com

U.S. and Canada

1-800-227-9770

agilent_inquiries@agilent.com

Europe

info_agilent@agilent.com

Asia Pacific

inquiry_lsca@agilent.com

DE44143.8123263889

This information is subject to change without notice.

© Agilent Technologies, Inc. 2022-2024
Published in the USA, May 15, 2024
5990-6495EN

