

High-Performance Liquid Chromatograph

# Co-Sense Series



High-Performance Liquid Chromatograph

## **Co-Sense Series**

### **LC Systems for a Diverse Range of Analytical Needs**

The Co-Sense for BA LC system represents an on-line sample preparation system, which utilizes restricted access media and the potential of a dilution channel for improving recovery from biological fluids.

By using this unique on-line trapping system, the Co-Sense for BA can be used to directly inject and analyze a large volume of biological samples while achieving excellent sensitivity. Co-Sense for Impurities uses a concentration column or trap between the first and second dimension separations to increase sensitivity and ensure components are separated. These systems are used to automate sample pretreatment, increase sensitivity, and achieve high separation for complex matrices, mainly in the pharmaceutical/biopharmaceutical, food, and life science research markets.



Shimadzu modular LCs can be configured into more than 100 different systems to cater to a wide range of analytical applications. From HPLC to UHPLC, systems can be configured for a wide range of needs and specific analytical objectives, such as for analyzing amino acids, hormones, drugs of abuse, organic acids, sugars, inorganic ions, and other more prevalent small molecules. The diversity of the Co-Sense system can be extended further by combining with LC/MS and LC-MS/MS.

# Co-Sense for BA

## Basic Concept of Co-Sense for BA

The Co-Sense for BA automatically and seamlessly performs all processes from sample pretreatment to analysis. This is achieved using a column-switching HPLC system equipped with the innovative Shimadzu Shim-pack MAYI-ODS pretreatment column and a unique on-line dilution bypass channel design.

### Trapping and Concentration

The dilution pump is used to dissociate large and small molecules to increase recovery of target analytes. This has the effect of breaking up large and small molecule complexes. This automatic dilution process ensures reliable trapping and concentration of target components by suppressing their interactions with the matrix and the impact of the sample solvent.

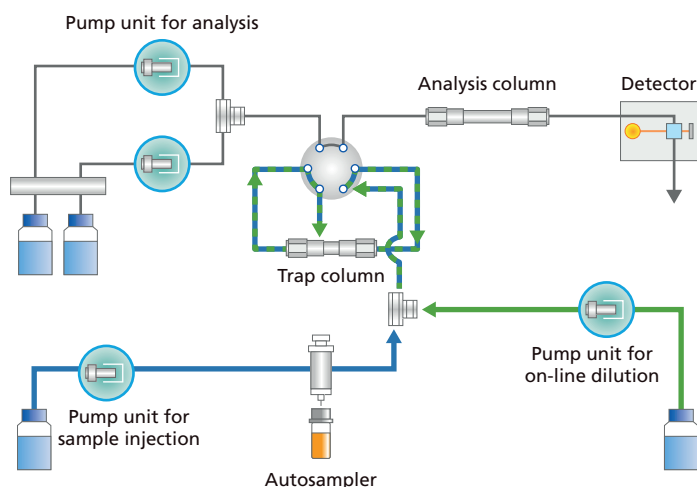

### Analysis

Once unwanted constituents have passed through the trapping column to waste, the target compounds are removed by a second independent gradient. Valve switching is used to transfer the target compounds through the second dimension column for analysis detection.

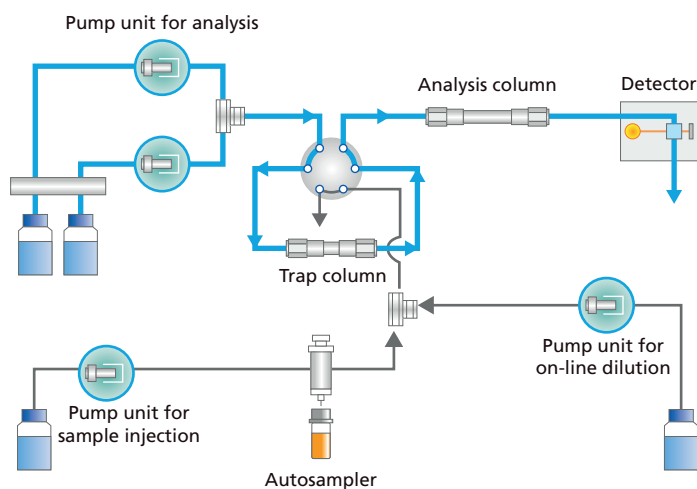

## Analyzing Biological Samples Using Co-Sense for BA

A major factor when analyzing low molecular weight compounds in biological samples, such as blood plasma and blood serum, is sample pretreatment, which mainly time-consuming deproteinization by liquid-liquid or solid phase extraction. However, by using the Shim-pack MAYI series on-line pretreatment column in combination with Co-Sense for BA, automated pretreatment and quantification of target compounds can be achieved in a fraction of the time compared to traditional methods. The system automation provides a high degree of reproducibility and confidence.

### Shim-pack MAYI Series

The Shim-pack MAYI series are restricted access media columns. They are on-line pretreatment columns for biological samples that feature a hydrophilic surface coating and optimized particle sizes to achieve highly efficient deproteinization and long-term stability. This provides excellent repeatability even for continuous analysis of multiple samples. In addition, five kinds of solid phases are offered for traps based on hydrophobic interaction (C1, C4, C8, C14, and ODS), and strong cation exchange (SCX) and strong anion exchange (SAX) mode solid phases are offered for traps based on ion-exchange effects.

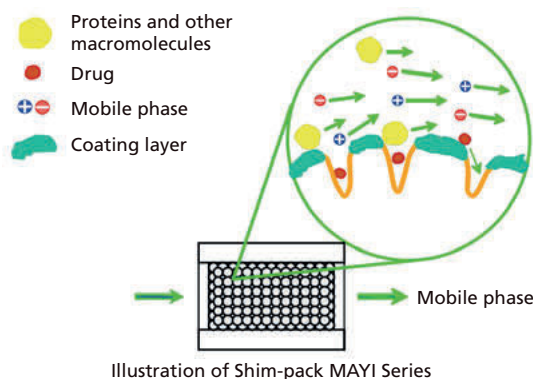

### Superior Recovery Rate Due to Dilution Trap

The concentration trap column in Co-Sense for BA inhibits the target components from interacting with proteins in samples. This allows reliably trapping and concentrating even components with high protein binding rates. A buffer solution or a solution containing a low-concentration organic solvent is used as the dilution solvent. As a result, even blood plasma (or blood serum) samples can be injected directly. In addition, due to excellent recovery rates and superior peak shapes, high sensitivity is achieved even for large-volume injections.

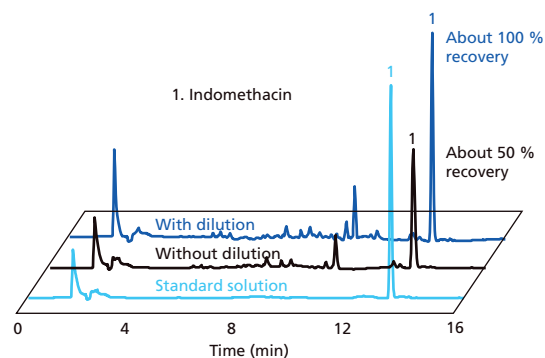

### Example of Analyzing Drugs in Blood Plasma

Higher efficiency and sensitivity can be achieved by using LC/MS for detection in the Co-Sense for BA system. In addition to saving time and money normally required for pretreatment by injecting blood plasma directly, LC/MS also allows quicker detection of specific components. Furthermore, automatic pretreatment by Co-Sense for BA inhibits matrix effects and allows higher precision analysis, even for direct injection of blood plasma.

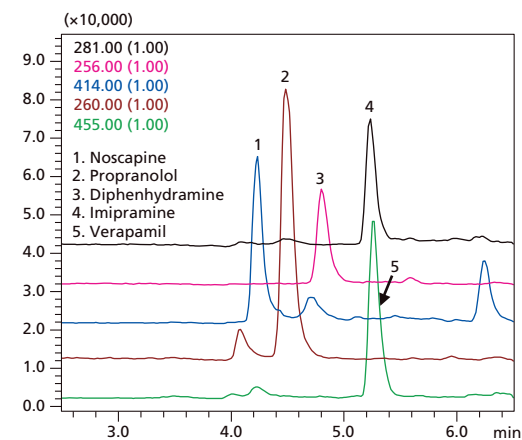

## Using Co-Sense for BA for Cleaning Validation

Though cleaning validation for pharmaceutical production equipment requires high-sensitivity analysis, samples are often obtained as dilute organic solvents. As a result, samples may need to be concentrated by pretreatment, which can reduce throughput. Co-Sense for BA can also be used to improve efficiency in cleaning validation applications by allowing samples to be injected directly in large volumes without having to first concentrate them.

### Issues for Cleaning Validation

Reversed phase mode analysis, which involves injecting large volumes of organic solvents or other solvents with strong elution properties as the sample solvent, tends to result in poor peak shapes. Cleaning validation for pharmaceutical production equipment often involves samples with ethanol or other organic solvents used as the sample solvent, which can impede injecting

large volumes for high-sensitivity analysis. In addition, ordinary trap injections may reduce recovery rates due to elution of target components from the trap column. As a result, in LC analysis for cleaning validation, samples are often concentrated in advance, leading to decreased throughput.

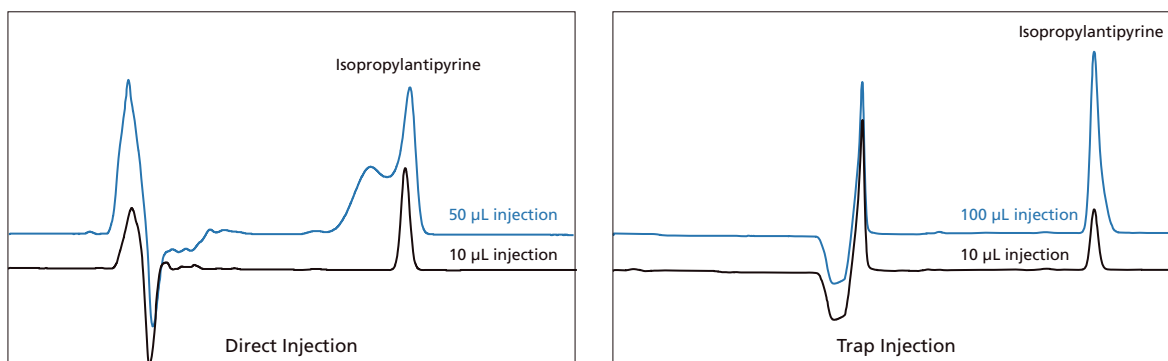

Example of Isopropylantipyrine Ethanol Solution Analysis Using a Traditional System

With large-volume injections using the direct injection method, the isopropylantipyrine peak shows a leading edge from the impact of the sample solvent. In addition, with trap concentration without on-line dilution, the recovery rate is decreased due to elution from the trap column because of the impact of the sample solvent.

### Superior Peak Shape and Recovery Rate Due to Dilution Trap

When injecting samples using the Co-Sense for BA system, samples are diluted on-line with water or a buffer solution as they are delivered to the trapping column. This is applicable even for large injection volumes of organic solvents. Consequently, this allows reliable trapping concentration even if a guard or other generic column is used as the trap column. In addition, the target components are introduced to the analysis column by valve switching after they are adequately concentrated on the trap column, so superior peak shapes can be obtained. High-sensitivity analysis of isopropylantipyrine in ethanol is difficult for traditional systems, but with Co-Sense for BA, approximately 100 % recovery rate and excellent peak shapes are obtained even with 100 µL injections.

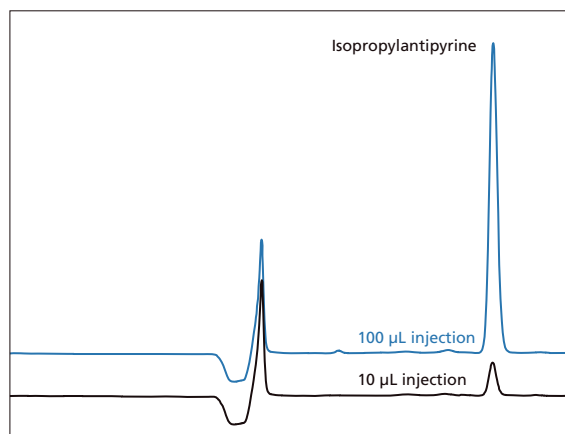

Example of Isopropylantipyrine Ethanol Solution Analysis Using Co-Sense for BA

# Analyzing Impurities in Antibody-Drug Conjugates Using Co-Sense for BA

Analyzing drug-derived impurities in pharmaceuticals containing antibody-drug conjugates (ADC) as a primary component requires removing the antibodies (deproteinization) in order to achieve high-sensitivity analysis of low molecular impurities. Co-Sense for BA used in combination with the Shimadzu Shim-pack MAYI series columns is able to efficiently analyze the impurities in antibody-drug conjugates, for example, by injecting large volumes of samples that are deproteinized on-line.

## Issues with Analyzing Impurities in Antibody-Drug Conjugates

To prevent cross contamination, impurity analysis should ideally involve as simple a process as possible and with high-sensitivity detection. However, when analyzing impurities in antibody-drug conjugates, deproteinization is required to eliminate high-concentration antibodies. If samples are pretreated by deproteinization using organic solvents or acids, the impact of the sample solvent can often worsen peak shapes, making it difficult to increase sensitivity through large-volume

injections. In addition, for samples with a high organic solvent ratio after deproteinization, the recovery rate may decrease with the traditional trap injection method due to the impact of the sample solvent. Furthermore, if on-line pretreatment (on-line solid phase extraction) is performed in order to automate deproteinization, the recovery rate of target impurities may decrease due to interactions between antibodies and drug-derived impurities.

## On-line Deproteinization Using the Shim-pack MAYI-ODS Column

With the Co-Sense for BA system, components can be trapped reliably to enhance sensitivity, even with large-volume injections, due to antibody removal (deproteinization) and the suppression of antibody and impurity interactions. The following shows an example of analyzing approximately 0.07 % (molar ratio) of impurities present in a 1 mg/mL antibody solution. By eliminating the impacts of antibodies, a recovery rate of approximately 100 % was achieved.

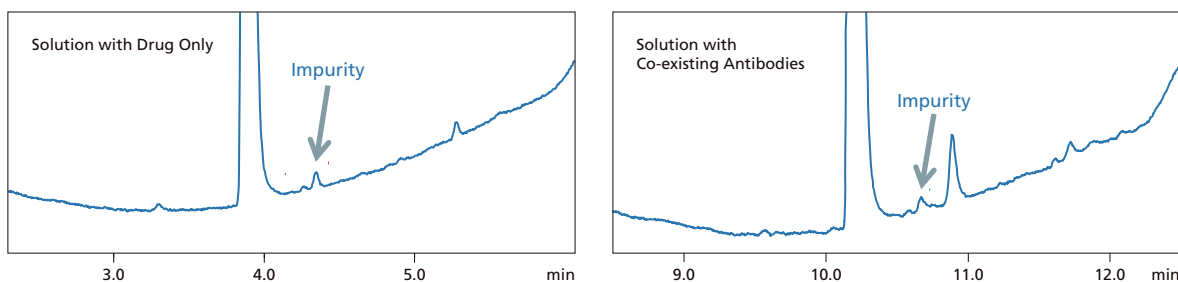

A comparison of using Co-Sense for BA to analyze a solution containing only the drug (left) and a solution containing a co-existing antibody (IgG) (right) shows a recovery of approximately 100 %, with results for the target impurity unaffected by the antibody.

## Peak Tracking by LC/MS

In addition, by using LC/MS for detection, it is also possible to reliably identify drug-derived impurities in antibody-drug conjugates.

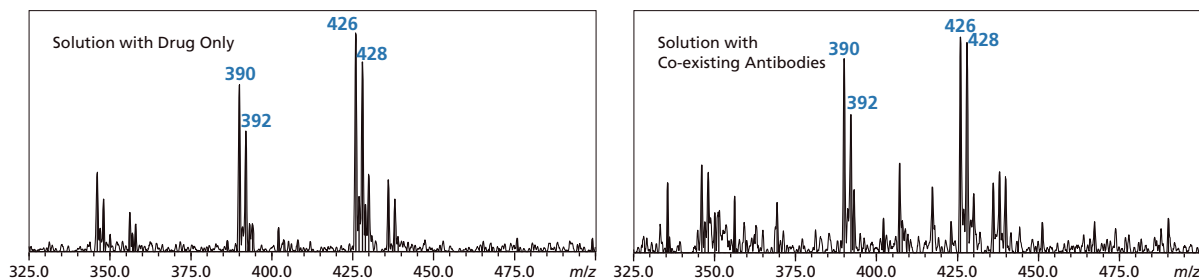

A comparison of the MS spectrum of impurity peaks from the drug-only solution (left) and the MS spectrum of impurity peaks obtained with Co-Sense for BA from the solution with co-existing antibodies (IgG) (right) shows that target impurities are clearly identified.



# Co-Sense for Impurities

## Basic Concept of Co-Sense for Impurities

Co-Sense for Impurities offers both two-dimensional high separation chromatography along with high sensitivity. It is especially useful for high-sensitivity analysis of ultra trace components or for analyzing components in complex matrices. The system uses trap concentration and on-line dilution after the first dimension separation. That means a guard column for

the first dimension separation or other general-purpose columns can be used as the trap column in two-dimensional reversed phase plus reversed phase separation. It can also be used for more complicated two-dimensional separation, such as normal phase plus reversed phase separation.

## Co-Sense for Impurities Configuration

In Co-Sense for Impurities, samples are first eluted through the first dimension separation column, through the first switching valve and subsequently through the trap column. This is on the timing of target component elution, where target components are reliably concentrated in the trap column while being diluted on-line. Next, by valve switching, the target components concentrated in the trap column are introduced to a second dimension separation column, where the samples are further separated and then detected.

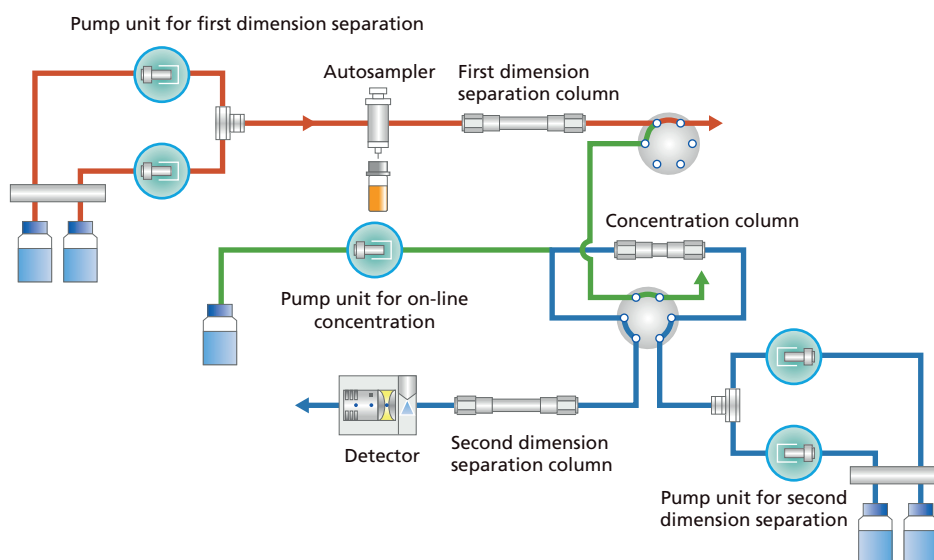

## Software for Co-Sense for Impurities

Control software designed specifically for Co-Sense for Impurities allows specifying settings separately for the first dimension separation, trap conditions, and second dimension separation in a manner similar to standard LC controls. It also allows visually monitoring the system status, mainly involving the mobile phase flow status. Therefore, it allows easily and accurately understanding the status of each flow line during analysis or cleaning.

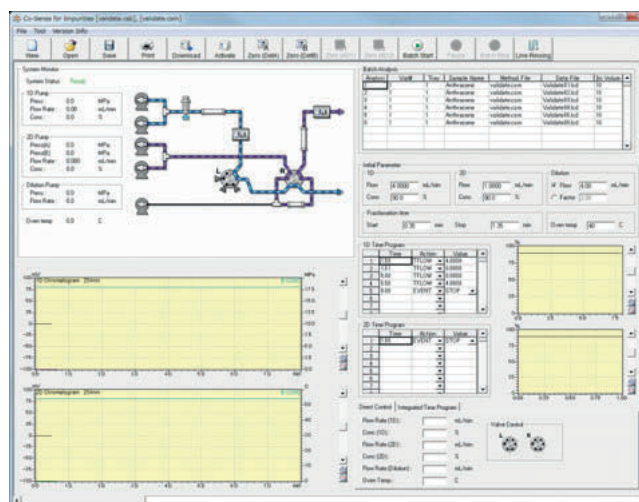



# Analyzing Ultra-Trace Impurities Using Co-Sense for Impurities

Analyzing ultra-trace impurities requires both increased sensitivity and reliable separation of impurities from primary components. Concentrating the sample or injecting large volumes of samples in an attempt to improve sensitivity can cause difficulties with achieving both solubility and separation. However, Co-Sense for Impurities is able to achieve both increased sensitivity and reliable separation by trapping and concentrating target impurities after large-volume injections and then separating them with second dimension separation.

## Higher Sensitivity Using Co-Sense for Impurities

Even in cases where increasing sensitivity is difficult with normal one-dimensional separation, Co-Sense for Impurities is able to increase sensitivity by approximately 40 times by combining a semi-preparative scale for first dimension separation and ultra-fast separation after trap concentration. This achieves high-sensitivity analysis with absorbance detection at a low operation cost.

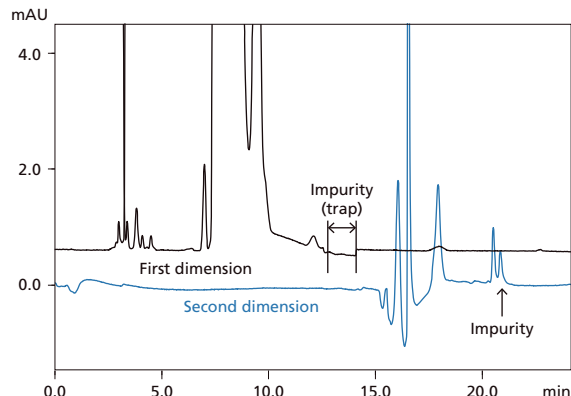

### Example of Analyzing 0.0002 % Impurities in Imipramine

In the first dimension separation, the 0.015 mAU peak was trap concentrated and then eluted as sharp peaks using a high-speed high-separation column. This resulted in increasing the sensitivity by approximately 40 times to 0.56 mAU. Also, increasing the sensitivity resulted in a good peak area repeatability of 1.08 %RSD, even for the ultra-trace impurity concentration of 0.0002 %.

## Analyzing Impurities Using Co-Sense for Impurities in Combination with LC/MS

Even if a non-volatile buffer solution is used as the mobile phase for the first dimension, Co-Sense for Impurities is able to desalt the solution by trap concentration. Consequently, it can be used in combination with LC/MS regardless of the separation conditions, which means impurities can be analyzed in more detail by LC/MS. Using LC/MS allows analyzing MS spectra and checking the specificity of peaks in MS chromatograms.

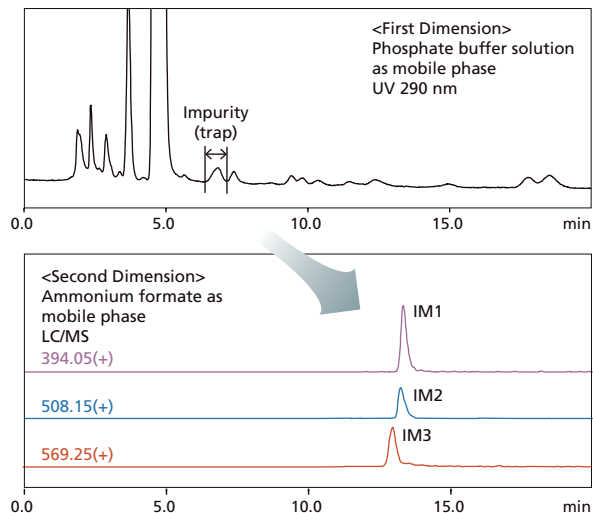

### Example of Analyzing Impurities in Rabeprazole

LC/MS analysis that was independent of the mobile phase conditions was accomplished by trap concentrating and desalting impurities detected by separation in a phosphate buffer solution, then delivering them with an LC/MS mobile phase to the second dimension. In addition, LC/MS allowed detecting the peak separation that could not be adequately verified based on UV detection.

## Analyzing Fat-Soluble Components Using Co-Sense for Impurities

The dilution trap in Co-Sense for Impurities allows combining various separation modes. Therefore, it can be used to automate first dimension pretreatment processes that previously served as an off-line pretreatment role and convert a separation mode not suitable for LC/MS to one optimal for LC/MS analysis.

### Example of Using LC/MS to Analyze Vitamin D<sub>3</sub> in a Vitamin Supplement

When analyzing fat-soluble components, samples are often pretreated using solid phase extraction to remove fat-soluble matrices. This can be automated using Co-Sense for Impurities with the first dimension for on-line pretreatment. It can also be used for combining normal and reversed phase separation modes.

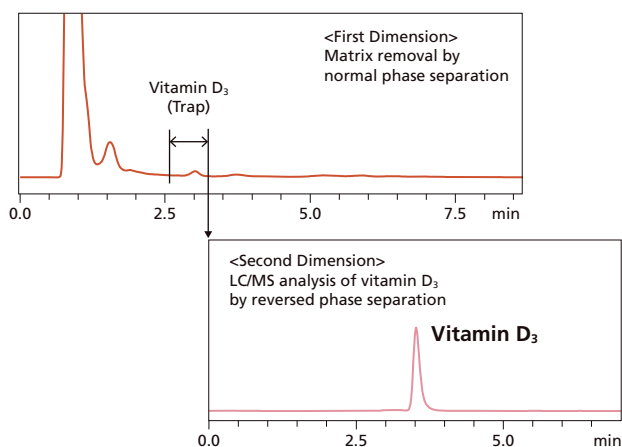

#### Example of Analyzing Vitamin D<sub>3</sub> in a Vitamin Supplement

The vitamin D<sub>3</sub> was separated from the matrix inside a soft capsule by using the normal phase mode for first dimension separation. After dilution trapping, the vitamin D<sub>3</sub> in the vitamin supplement can be analyzed without matrix effects by delivering it to LC/MS using reversed phase separation.

### Example of Analyzing Phospholipids by LC/MS

With phospholipid analysis using only reversed phase separation, it is difficult to quantify the phospholipids appropriately, due to ion suppression or enhancement effects resulting from various co-existing phospholipids. However, the adoption of Co-Sense for Impurities allows quantifying phospholipids precisely by using normal phase separation to separate phospholipids by form in the first dimension and then using reversed phase separation in the second dimension to deliver samples to LC/MS.

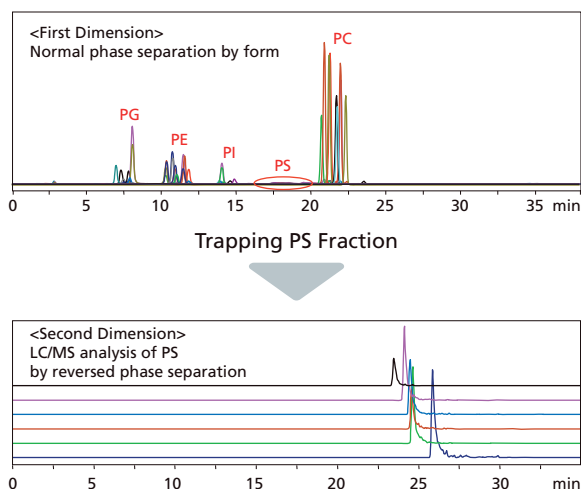

#### Example of Analyzing Phospholipids

In the first dimension, phosphatidylserine (PS) is separated from other phospholipids by normal phase separation. After dilution trapping, the samples are separated based on fatty acids in the reversed phase separation and then detected by LC/MS. This inhibits any impacts from other phospholipids and allows analyzing only phosphatidylserine (PS).

## Analyzing Natural Products Using Co-Sense for Impurities

Analyzing ultra-trace components in natural products requires both reliable separation of target components from contaminant components and increased sensitivity. In particular, concentrating liquid samples, such as fruit juices, in the pretreatment process not only reduces throughput, but can also cause cross contamination. However, Co-Sense for Impurities is able to analyze such liquid samples efficiently by direct injection. Furthermore, using an ultra-fast separation column can significantly reduce the separation time.

### Analysis Using a Traditional System

When analyzing trace components in natural products with a traditional system, it is difficult to achieve both the separation and high sensitivity necessary to eliminate the impacts of contaminants and selectively detect target components.

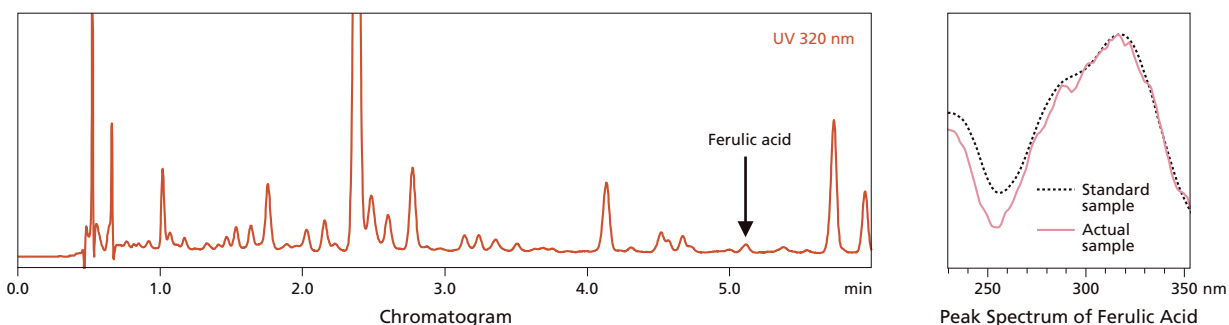

#### Example of Using a Traditional System for Analyzing Berry Juice

A comparison of the absorbance spectra for ferulic acid in standard and actual samples does not show adequate matching, which suggests the spectra were affected by contaminant components.

### High-Sensitivity Analysis Using Co-Sense for Impurities

By using the Shim-pack XR-ODS ultra-fast separation column for both the first and second dimensions and by changing the mobile phase pH level used for separation in the first and second dimensions, both fast separation and high sensitivity were achieved by reliably separating contaminant components.

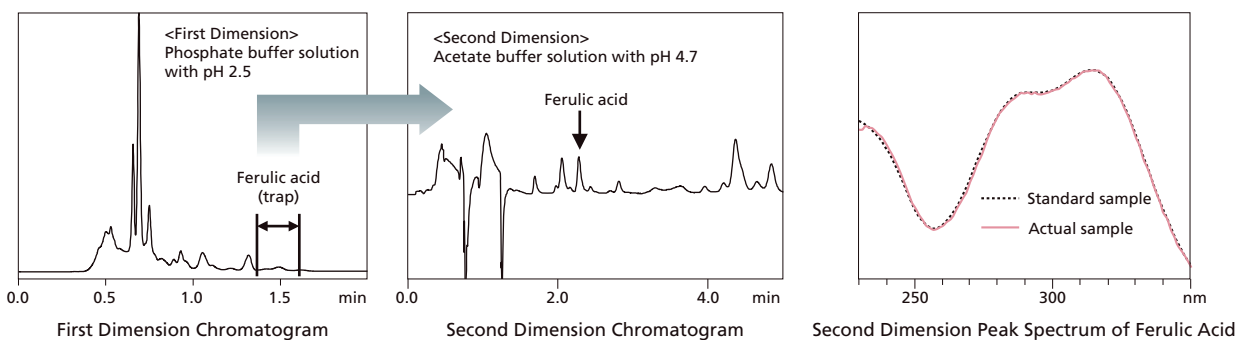

#### Example of Analyzing Ferulic Acid in Berry Juice

With reliable separation of contaminant components by automated on-line pretreatment (absorption spectra of standard and actual samples matched) and high sensitivity, good precision was achieved even for the actual sample, with a peak area repeatability of 0.6 % RSD. Also, using the Shim-pack XR-ODS ultra-fast separation column allowed achieving high-speed two-dimensional separation.



Shimadzu Corporation  
[www.shimadzu.com/an/](http://www.shimadzu.com/an/)

Company names, product/service names and logos used in this publication are trademarks and trade names of Shimadzu Corporation or its affiliates, whether or not they are used with trademark symbol "TM" or "®".  
Third-party trademarks and trade names may be used in this publication to refer to either the entities or their products/services. Shimadzu disclaims any proprietary interest in trademarks and trade names other than its own.

For Research Use Only. Not for use in diagnostic procedures.  
The contents of this publication are provided to you "as is" without warranty of any kind, and are subject to change without notice. Shimadzu does not assume any responsibility or liability for any damage, whether direct or indirect, relating to the use of this publication.