

Relentless Innovation
the path to
Mass Spec/tacular

John Fjeldsted
Director, R&D
LC/MS Division

Agilent Technologies
Santa Clara, CA

Our Agenda...

- Start with the Agilent R&D History
- Examine product goals and specifications.
- Learn about Agilent Jet Stream Technology
- Discover a new level of QTOF performance in the 6530 QTOF
- Find out how software innovation makes old workflows better and new workflows possible

Agilent's 35+ Years in Mass Spectrometry

Nearly 40,000 systems – Applied to Chromatographic Analysis



Cutting Edge 6530 Q-TOF Performance

With...

Agilent Jet Stream Technology

True Hi-Def TOF Technology

Unmatched sensitivity, speed and mass accuracy

Unique data mining tools for faster compound ID



- ✓ Mass accuracy – approaching FTMS mass accuracy
- ✓ Sensitivity- high femtogram level detection
- ✓ Increased resolving power – 20,000
- ✓ Extended dynamic range – approaching 5 Decades in-Scan
- ✓ Acquisition speed – approaching 10 MS/MS per second

Leads the industry in all dimensions*

* For systems less than 0.5 Ton and 9 feet in height

Agilent QTOF Product Specifications

	6510	6520	6530
Sensitivity in MS mode; reserpine	5 pg; 10:1 S/N 1xRMS	5 pg; 10:1 S/N 1xRMS	1 pg; 10:1 S/N 1xRMS
Sensitivity in MS/MS mode; reserpine	5 pg; 50:1 S/N 1xRMS	5 pg; 50:1 S/N 1xRMS	1 pg; 50:1 S/N 1xRMS
Mass accuracy	<2 ppm- MS < 5ppm- MS/MS	< 2ppm- MS < 5ppm- MS/MS	<2 ppm- MS < 5 ppm MS/MS
Mass resolution	5,000 @ 118 m/z 12,000 @ 1522 m/z	10,000 @ 118 m/z 18000 @ 1522 m/z	10,000 @ 118 m/z 20,000 @ 1522 m/z
Dynamic range	3.5 orders	5.0 orders	5.0 orders
Mass range	13,000 m/z TOF	4,000 m/z quad 20,000 m/z TOF	8,000 m/z quad (opt) 20,000 m/z TOF
Acquisition speed scan/sec MS	Up to 20 scan/sec	Up to 20 scan/sec	Up to 20 scan/sec
Acquisition speed scan/sec MS/MS	Up to 9 scan/sec	Up to 9 scan/sec	Up to 9 scan/sec

6530 QTOF Sensitivity with Agilent Jet Stream 1 pg Reserpine, MS S/N 10:1

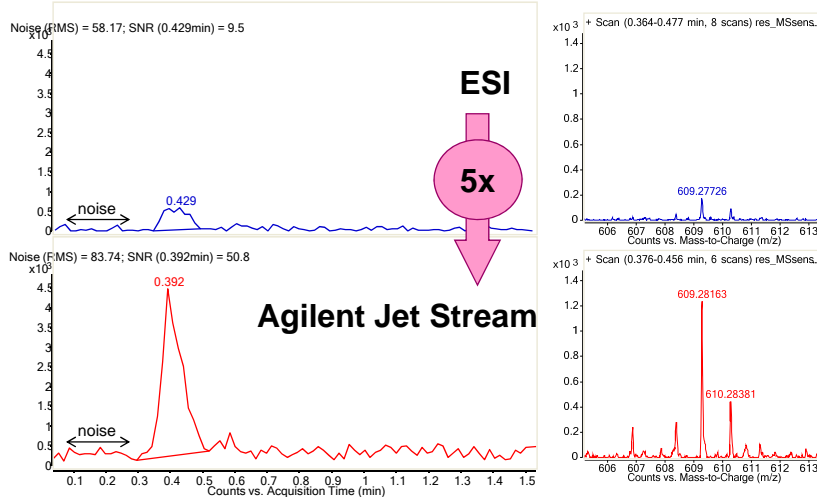

These data were acquired with 75/25 MeOH/water on a 2.1x30mm 3.5um column. Final specs will use ACN/water and a 1.8um column and be common with the 6460 QQQ checkout

6530 QTOF Sensitivity with Agilent Jet Stream 1 pg Reserpine, MS/MS

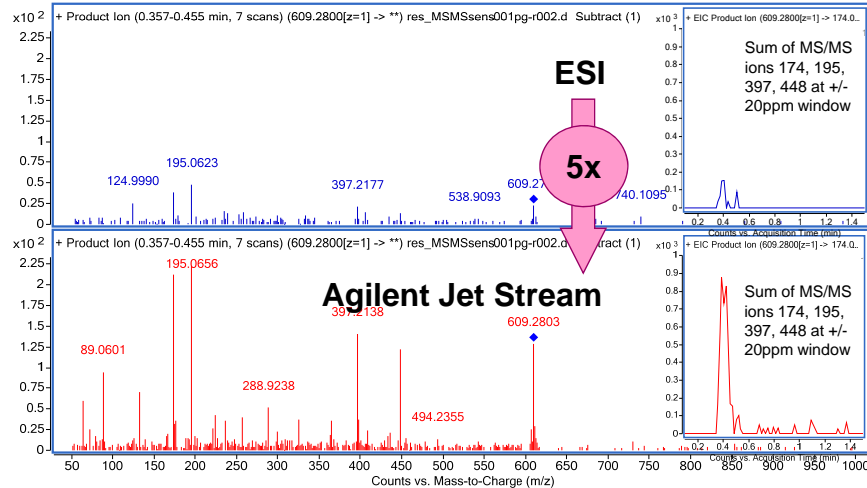

These data were acquired with 75/25 MeOH/water on a 2.1x30mm 3.5um column. Final specs will use ACN/water and a 1.8um column and be common with the 6460 QQQ checkout

Our Agenda...

- Start with the Agilent R&D History
- New product specifications. They're fantastic!
- Learn about Agilent Jet Stream Technology
- Discover a new level of QTOF performance in the 6530 QTOF
- Find out how software innovation makes old workflows better and new workflows possible

Agilent's LC/MS Systems – Innovation Inside

6100 Series SQ

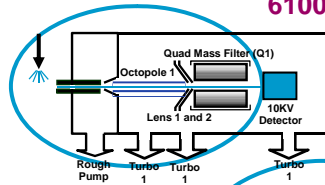

New Collision Cell Incorporates Axial Acceleration for High Speed MS/MS Analysis

6410 QQQ

6510 Q-TOF

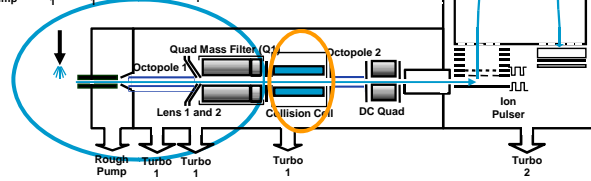
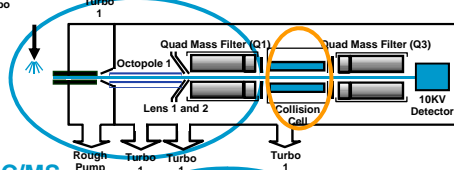

Over 10 Years in LC/MS Atmospheric Sampling and Patented Orthogonal Geometry - Result in Industry Leading Sensitivity and Robustness

Page 9

Agilent Technologies

LCMS - ASMS 2008
Agilent Restricted

Agilent Jet Stream Ion Generation Gas Dynamics View

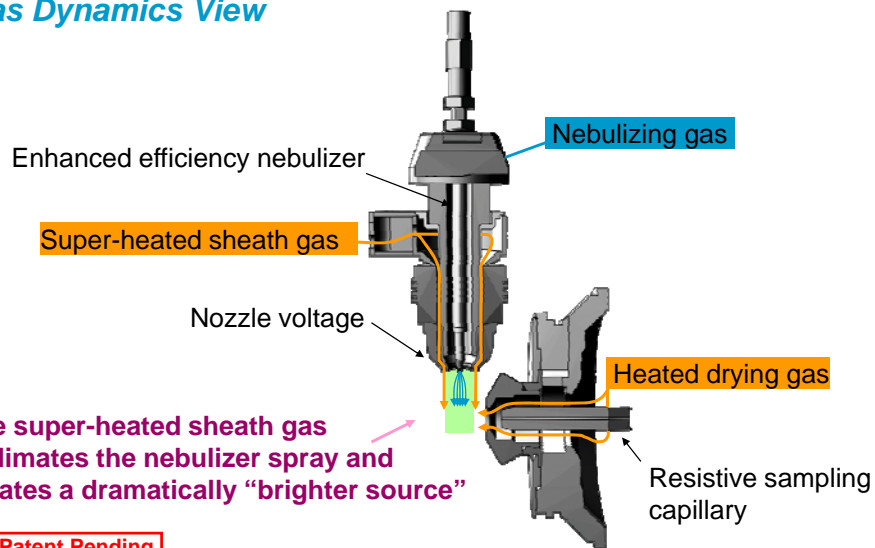

Page 10

Agilent Technologies

LCMS - ASMS 2008
Agilent Restricted

Agilent Jet Stream Ion Generation *Thermal Dynamics View*

This plot is a simulation showing the **thermal profile** of the Agilent Jet Stream Source

Thermal energy is focused to the nebulizer spray

Thermal focusing produces the most efficient desolvation and ion generation possible!

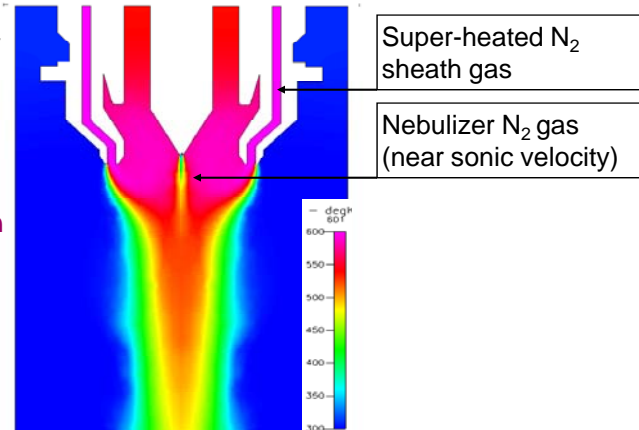

Patent Pending

Page 11

Agilent Technologies

LCMS - ASMS 2008
Agilent Restricted

Agilent Jet Stream In Action *Observing Thermal Focusing*

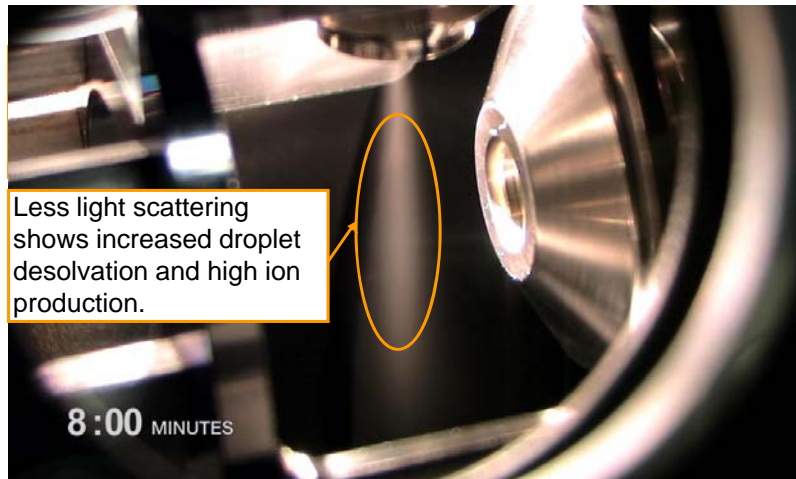

Start temperature = 25 °C

Stop temperature = 400 °C

Page 12

Agilent Technologies

LCMS - ASMS 2008
Agilent Restricted

Agilent Jet Stream Performance Signal Enhancement – 6460 QQQ

12 Pesticides

Relative increase in signal of
Agilent Jet Stream vs ESI = 5.8x

Pesticide	Optimal Temp [°C]	Signal Gain
Alar	380	5.60
Acephate	380	6.30
Oxamyl	250	5.10
Carbendazim	380	7.20
Thiabendazole	380	7.20
Carbaryl	380	6.60
Imazalil	380	8.10
Methidathion	250	5.00
Chlorpyrifos-methyl	100	6.40
Pirimiphos-methyl	380	5.50
Chlorpyrifos	380	4.00
Trans-permethrin	250	2.50
Average		5.8x

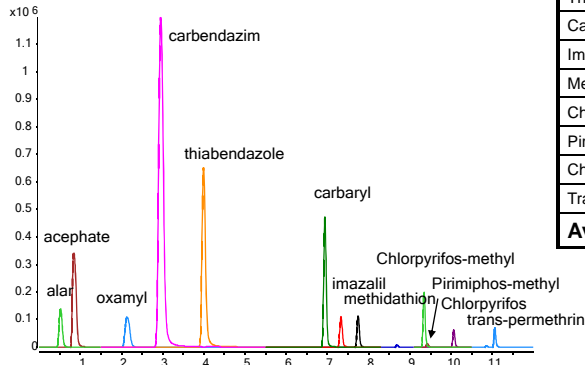

Page 13

Agilent Technologies

LCMS - ASMS 2008
Agilent Restricted

Agilent Jet Stream Performance Effect of Matrix on Response – 6460 QQQ

Results show 4 therapeutics in analyzed in solvent and plasma

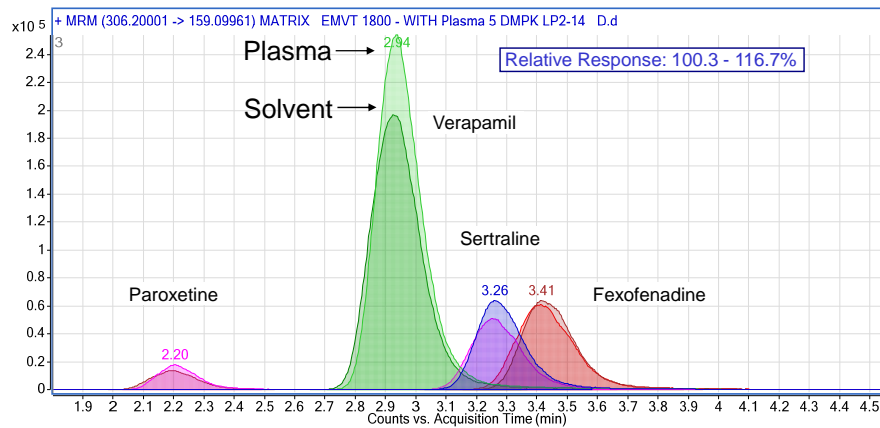

Page 14

Agilent Technologies

LCMS - ASMS 2008
Agilent Restricted

Agilent Jet Stream Performance Ruggedness & Reproducibility – 6460 QQQ

500 Injections of Alprazolam in Spiked Human Plasma Extract, ~ 10hrs.

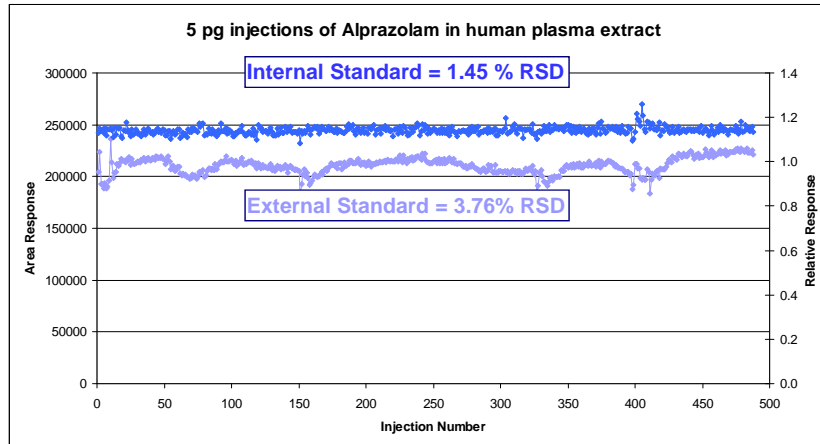

Agilent's LC/MS Systems – Innovation Inside

6100 Series SQ

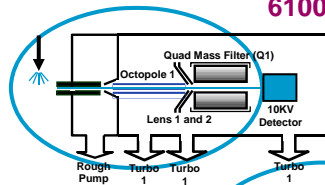

New Collision Cell Incorporates
Axial Acceleration for High Speed
MS/MS Analysis

6410 QQQ

6510 Q-TOF

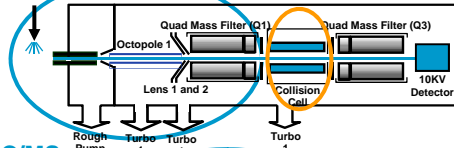

Over 10 Years in LC/MS
Atmospheric Sampling and Patented
Orthogonal Geometry -
Result in Industry
Leading Sensitivity and
Robustness

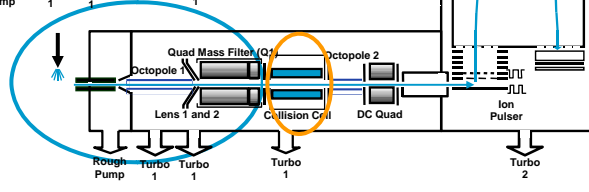

Axial Acceleration Collision Cell

Designed for QQQ and QTOF Mass Spectrometers

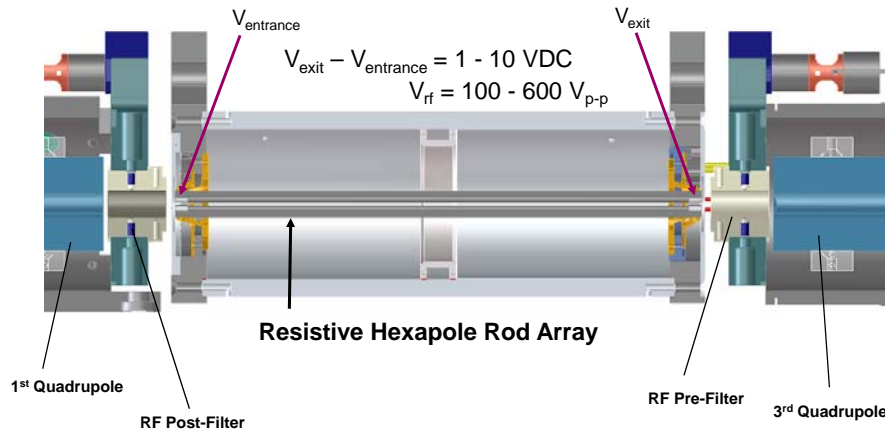

Shown is the Agilent 6410 Triple Quad

Axial Acceleration Collision Cell

Sub-millisecond ion transport times

Axial acceleration overcomes memory or cross-talk effects

Wide mass range small r_0
hexapole design maximizes sensitivity

Single accelerating potential is easy to operate.

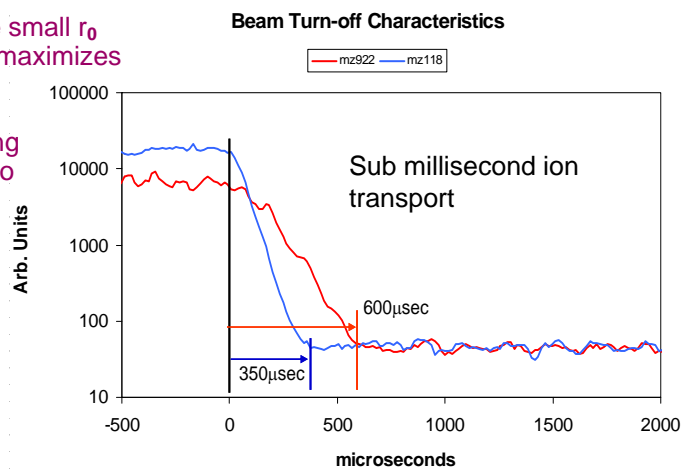

Agilent's LC/MS Systems – Innovation Inside

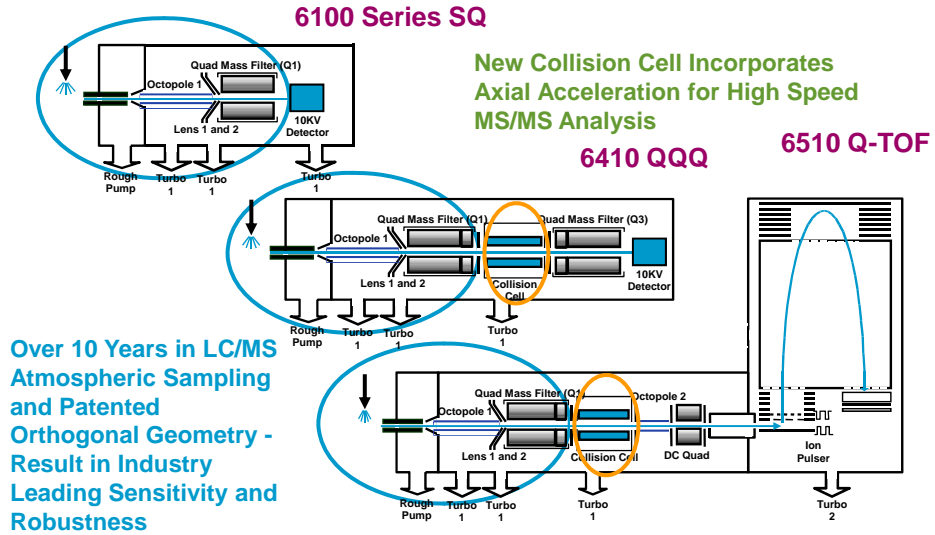

Page 19

Agilent Technologies

LCMS - ASMS 2008
Agilent Restricted

New Ultra High Speed Acquisition

Matching TOF/QTOF Analyzers and Electronics Performance

Two New Modes: **4 GHz for Enhanced Resolving Power**
2-Channel x 2 GHz Dual Gain for Extended Dynamic Range

- 4 GHz (8 bit) Analog-Digital-Converter **ADC**
 - Adapted from Agilent's High Speed Oscilloscope Systems
- Ultra High Speed **FPGA** process and store transients in real time
 - Up to 20,000 m/z depth

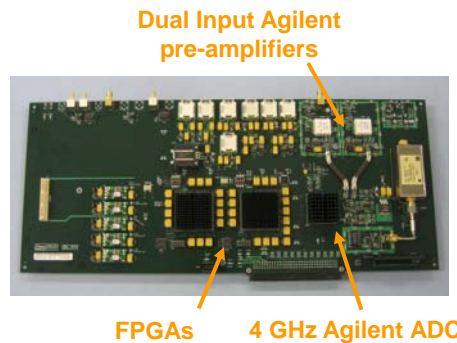

Page 20

Agilent Technologies

LCMS - ASMS 2008
Agilent Restricted

Mass Accuracy: Terfenadin

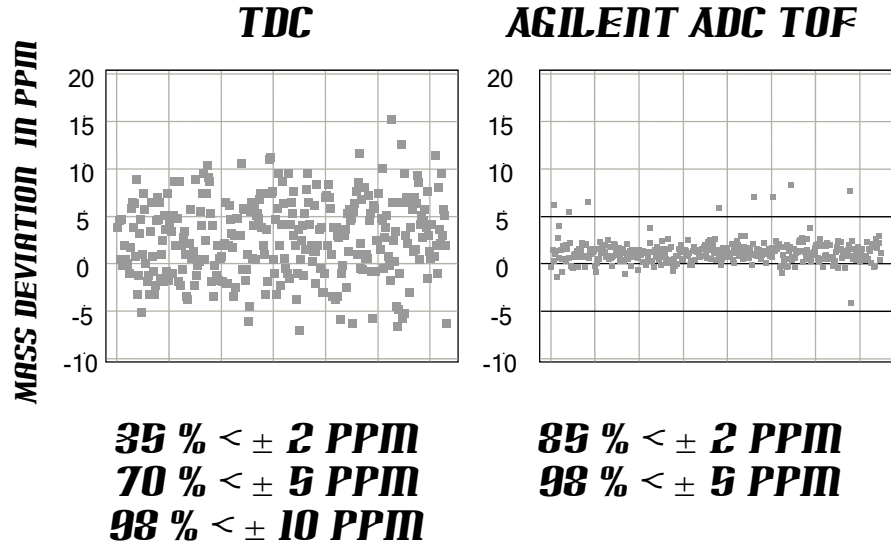

Page 21

Agilent Technologies

LCMS - ASMS 2008
Agilent Restricted

Enhanced Resolving Power

High Mass Accuracy for Isobars over Wide Dynamic Range

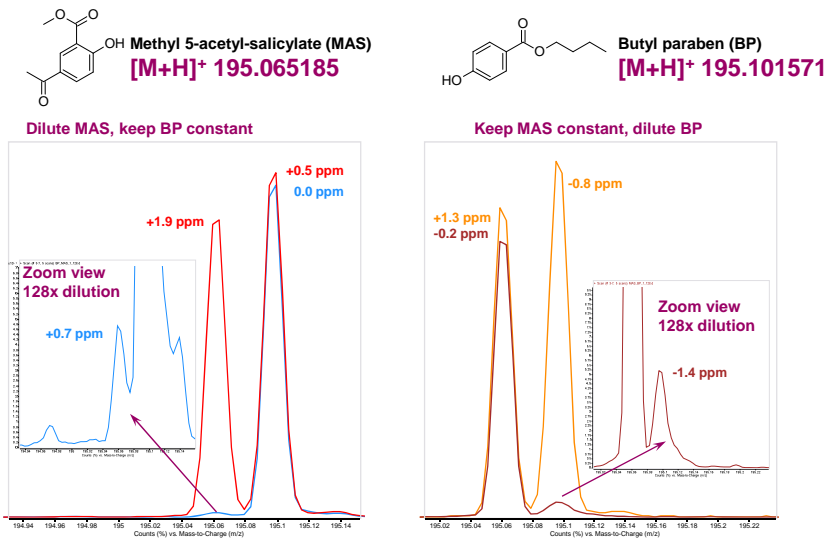

Page 22

Agilent Technologies

LCMS - ASMS 2008
Agilent Restricted

Molecular Formula Generation from Isotopic Pattern

Sulfadimethoxine

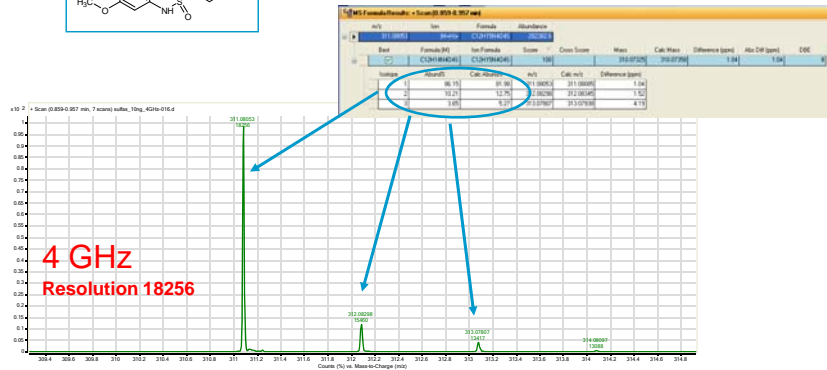
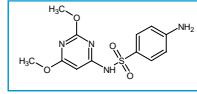

MS/MS Fragmentation Pathways

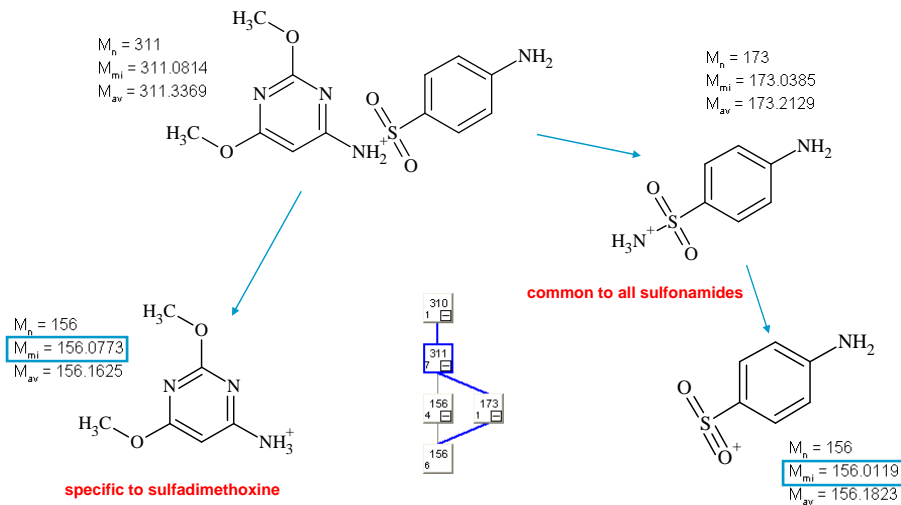

Sulfadimethoxine – MS/MS Fragmentation

m/z 156.0119

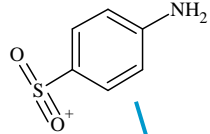

m/z 156.0773

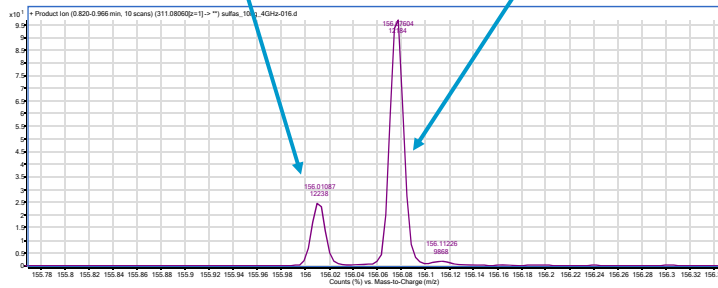
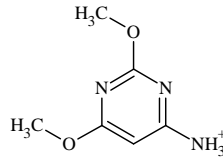

Page 25

Agilent Technologies

LCMS - ASMS 2008
Agilent Restricted

High Output PMT Based TOF Detector

PMT delivers needed output current for wide dynamic range

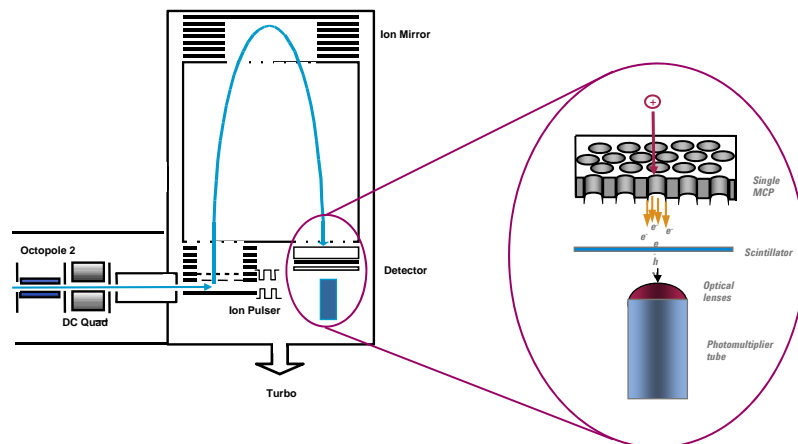

Page 26

Agilent Technologies

LCMS - ASMS 2008
Agilent Restricted

New 4GHz Acquisition System up to 5 Decades of In-Spectrum Dynamic Range

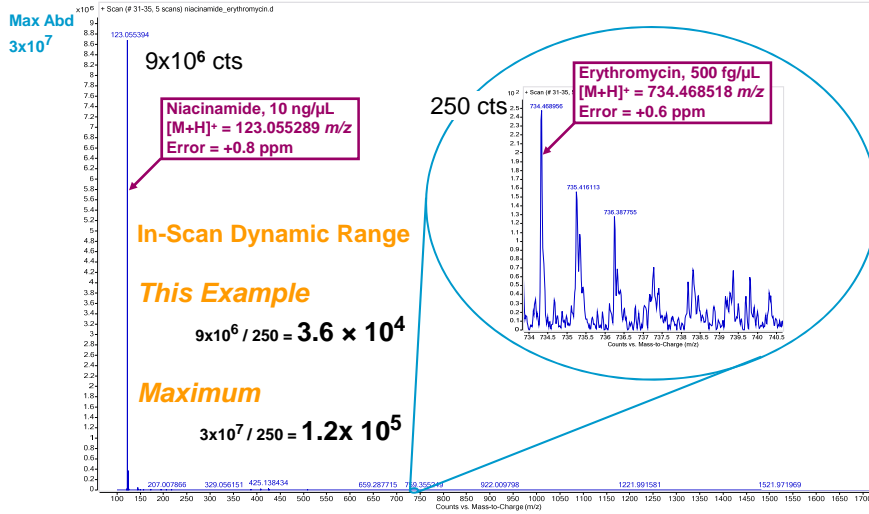

Agilent 6460 QQQ and 6530 QTOF What Else is New ?

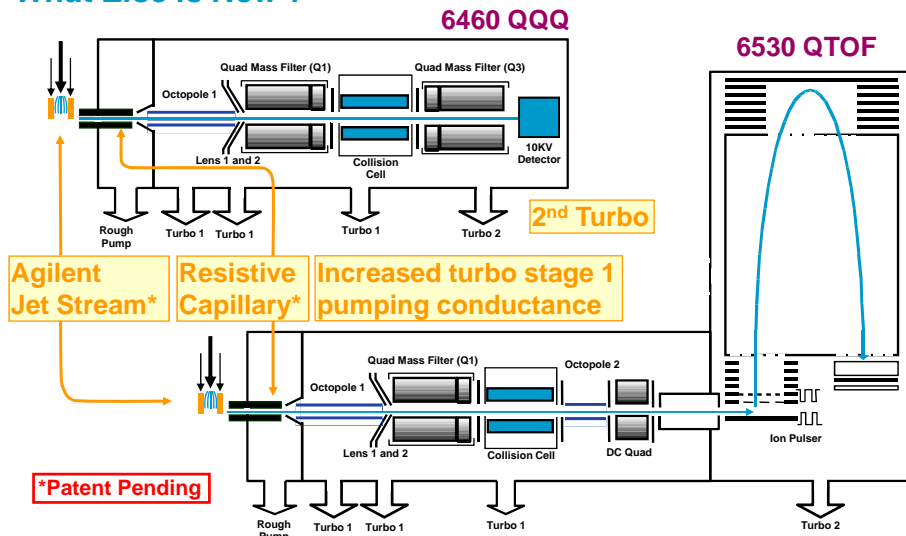

Our Agenda...

- Start with the Agilent R&D History
- New product specifications. They're fantastic!
- Learn about Agilent Jet Stream Technology
- Discover a new level of QTOF performance in the 6530 QTOF
- Find out how software innovation makes old workflows better and new workflows possible

Agilent 6530 QTOF Performance Agilent Jet Stream vs. ESI For 1 pmol BSA Digest – MS Mode Peptide Map

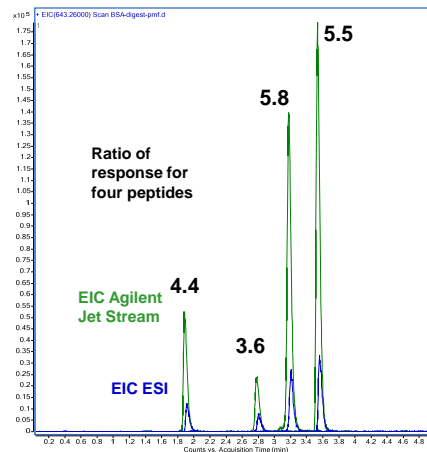
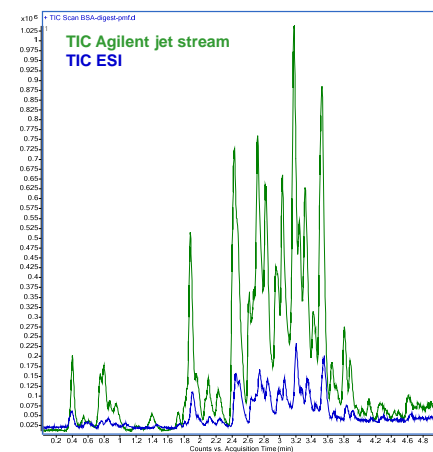

Protein Identification Summary

Sum Of Two Injections Per Condition, AutoMS/MS Mode

Significant gains at low concentrations

Amount Injected	# unique peptides		Protein Score		Sequence Coverage (%)	
	ESI	Agilent Jet Stream	ESI	Agilent Jet Stream	ESI	Agilent Jet Stream
100 fmol	9	21	111	282	15	45
200 fmol	17	28	209	399	31	51
500 fmol	26	31	374	476	44	57
1000 fmol	33	42	494	674	59	69

Agilent QTOF – Accelerating Data Dependent MS/MS

The intensity of the precursor ion is used to set the number of MS/MS transients

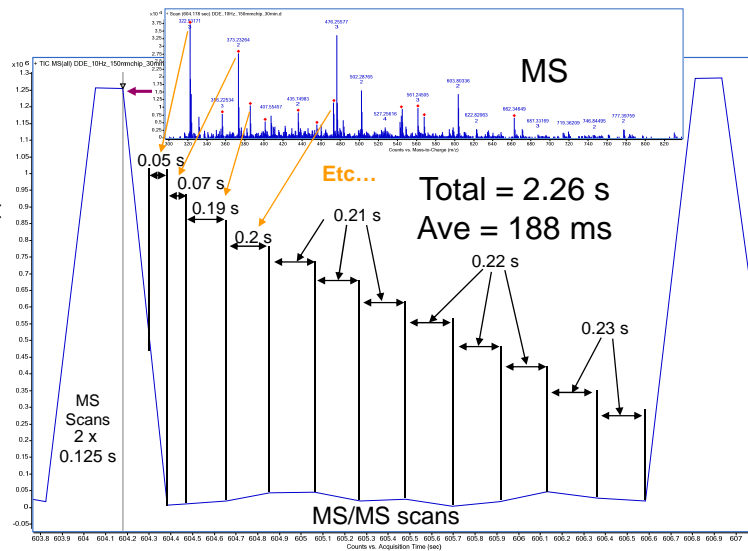

Agilent QTOF – Accelerating Data Dependent MS/MS

Initial
8 Hz MS
3 Hz MS/MS

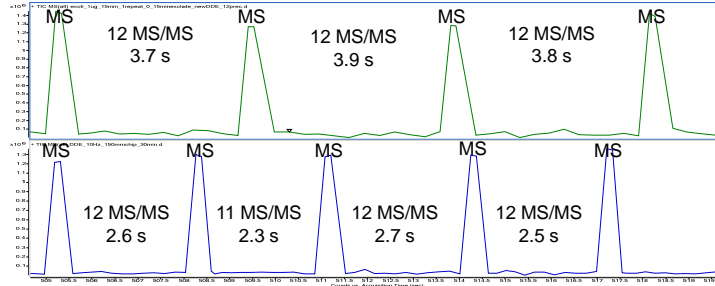

Auto MS/MS Parameter	Initial	Faster	Accelerated
MS/MS acquisition rate (spectra/s)	3	4	4.6
Excluded after __ spectra	2	1	1
Released after __ min	0.30	0.15	0.15
Valid ID's in a 20 min LC/MS/MS run of trypsin-digested <i>E. coli</i> proteins	693	1069	1162
	179	234	247

Page 33

Agilent Technologies

LCMS - ASMS 2008
Agilent Restricted

Triazines Spiked Into Tomato Matrix, 500 ppt 6530 QTOF, MS Mode, Extended Dynamic Range

2GHz Extended Dynamic range
Notice 4×10^6 signal

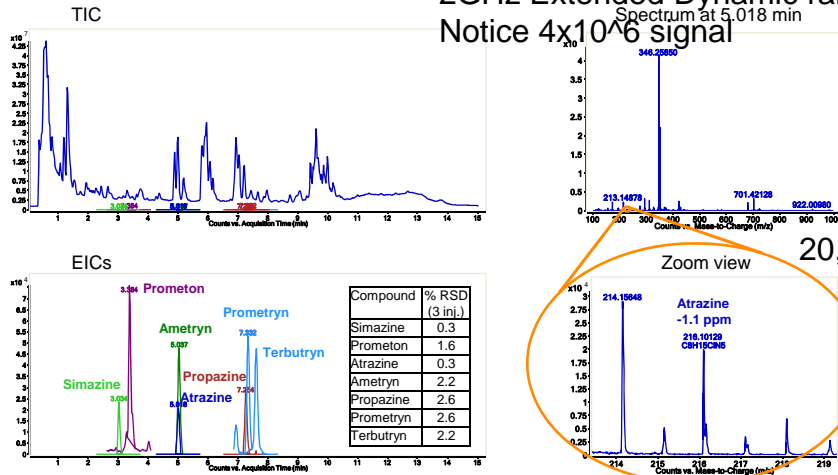

Note: on-column amount is 5 pg (10 μ L x 500 ppt).
Identification done by database searching

Page 34

Agilent Technologies

6530 QTOF Applications Overview
LCMS - ASMS 2008
Agilent Restricted

Triazines Spiked Into Tomato Matrix, 100 ppt 6530 QTOF, Targeted MS/MS Mode

On-column amount is 1 pg (10 µL x 100 ppt)

Compound	Precursor	Product Ion(s)	Collision energy, V	% RSD (3 inj.)
Simazine	202.0849	124.0868+132.0317	20	13.2
Prometon	226.1662	142.0717+184.1189	20	1.5
Atrazine	216.1010	174.0539	20	16.0
Ametryn	228.1277	186.0803	20	10.1
Propazine	242.1435	158.0487+200.0962	20	17.2
Prometryn	230.1177	146.0226+188.0692	25	14.2
Terbutryn	242.1435	186.0803	20	12.6

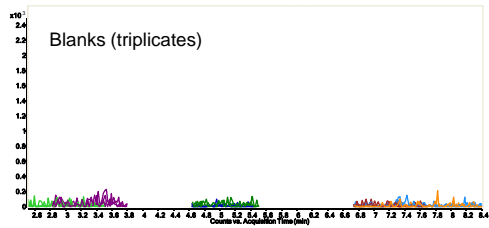
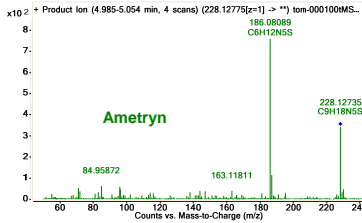
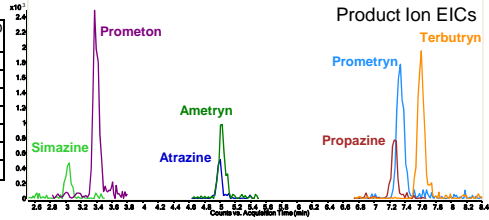

Page 385

Agilent Technologies

6530 QTOF Applications Overview
LCMS - ASMS 2008
Agilent Restricted

Ritonavir Microsomal Incubation Minor Metabolites Effect Of Agilent jet stream Sheath Gas Temperature

Demethyl hydroxy metabolites

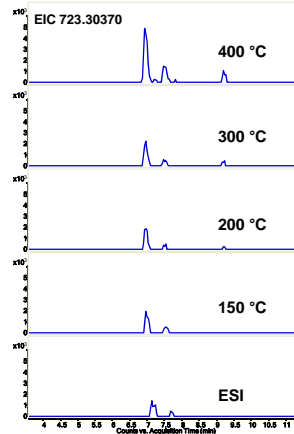

Dihydroxy metabolites

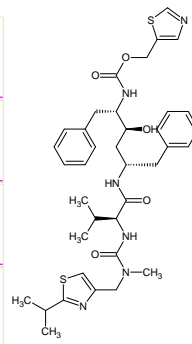
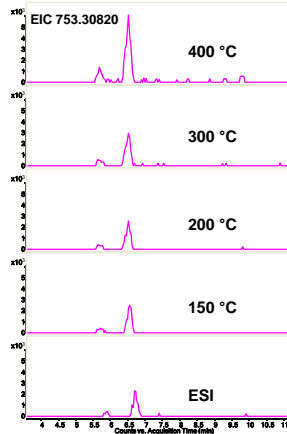

10 µL injection for all samples

Page 386

Agilent Technologies

6530 QTOF Applications Overview
LCMS - ASMS 2008
Agilent Restricted

Ritonavir Microsomal Incubation Minor Metabolites Metabolite ID Results

Name	RT	Mass	m/z	Qualified	Relevance	User Qual.	Qualified	Qualified	Qualified	Qualified
Ritonavir	11.509	720.3117	721.3193	☑	100.0	☑	☑	☑	☑	☑
Methylene to Ketone	11.366	734.2906	735.2979	☑	71.4	☑	☑	☑	☑	☑
Methylene to Ketone	12.695	734.2942	735.3015	☑	71.4	☑	☑	☑	☑	☑
Hydroxylation and Ketone Formation	8.861	750.2851	751.1901	☑	71.4	☑	☑	☑	☑	☑
Hydroxylation and Dehydration	8.260	719.3016	720.1561	☑	35.7	☑	☑	☑	☑	☑
Hydroxylation and Dehydration	11.609	719.2976	720.1561	☑	35.7	☑	☑	☑	☑	☑
Hydroxylation and Dehydration	11.613	719.2971	719.3044	☑	71.4	☑	☑	☑	☑	☑
Hydroxylation and Dehydration	12.709	719.2961	719.3034	☑	35.7	☑	☑	☑	☑	☑
Hydroxylation	7.930	736.3070	737.1610	☑	35.7	☑	☑	☑	☑	☑
Hydroxylation	8.270	736.3081	737.1614	☑	100.0	☑	☑	☑	☑	☑
Hydroxylation	9.980	736.3022	737.1615	☑	25.7	☑	☑	☑	☑	☑
Hydroxylation	10.101	736.3054	737.1727	☑	35.7	☑	☑	☑	☑	☑
Demethylation and two Hydroxylations	5.584	739.2959	740.1502	☑	35.7	☑	☑	☑	☑	☑
Demethylation and Methylene to Ketone	3.213	720.2752	721.2825	☑	71.4	☑	☑	☑	☑	☑
Demethylation and Hydroxylation	6.953	722.2919	723.1530	☑	100.0	☑	☑	☑	☑	☑
Demethylation and Hydroxylation	7.901	722.2961	723.1592	☑	71.4	☑	☑	☑	☑	☑
Demethylation	3.740	736.2967	737.1596	☑	77.8	☑	☑	☑	☑	☑
Hydroxylation	11.504	676.3223	677.1804	☑	64.9	☑	☑	☑	☑	☑
2α Hydroxylation	5.688	752.3009	753.3042	☑	71.4	☑	☑	☑	☑	☑
2α Hydroxylation	6.515	752.3022	753.1593	☑	100.0	☑	☑	☑	☑	☑

Agilent
jet stream

These are the minor metabolites
shown on the previous slide

Note! The literature reference shows
11 metabolites using 2X the injection
volume and 3X the gradient length.

ESI
No other minor
metabolites detected

Name	RT	Mass	m/z	Qualified	Relevance	User Qual.	Qualified	Qualified	Qualified	Qualified
Ritonavir	11.628	720.3140	721.3213	☑	100.0	☑	☑	☑	☑	☑
Hydroxylation and Dehydration	11.644	719.2974	719.3046	☑	71.4	☑	☑	☑	☑	☑
Hydroxylation	8.217	736.3084	737.1610	☑	100.0	☑	☑	☑	☑	☑
Demethylation	9.789	736.2956	737.3029	☑	71.4	☑	☑	☑	☑	☑

Page 377

Agilent Technologies

6530 QTOF Applications Overview
LCMS - ASMS 2008
Agilent Restricted

Ritonavir Minor Metabolite—MFG Improvements

- Modified detector gain adjustment and optimized MFG scoring algorithm
- [A+1]/[A] ratio improved from 87% of theoretical to 99%
- MFG score improved from 87 to 98
- MFG ranking improved from 8th place to 1st place on hit list



Page 380

Agilent Technologies

6530 QTOF Applications Overview
LCMS - ASMS 2008
Agilent Restricted

Diclofenac Microsomal Incubation Minor Metabolites Trapped With Glutathione

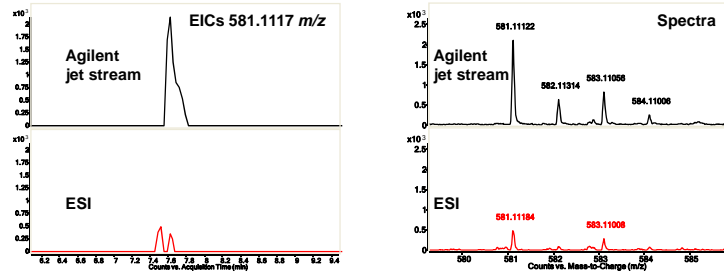

Metabolite ID results

Agilent
jet stream
Two glutathione
conjugates detected

ESI
No glutathione
conjugates detected

Name	RT	Mass	m/z	Qualified	Reference	User Qual	Qualified	Mass D.	Isotopic...
Hydrolyzation	11.726	311.0129	310.0049	<input checked="" type="checkbox"/>	100.0	<input checked="" type="checkbox"/>	<input checked="" type="checkbox"/>	<input checked="" type="checkbox"/>	<input checked="" type="checkbox"/>
Glutathione Conjugation, hydrolyzation-HCl	7.617	582.1190	581.1117	<input checked="" type="checkbox"/>	100.0	<input checked="" type="checkbox"/>	<input checked="" type="checkbox"/>	<input checked="" type="checkbox"/>	<input checked="" type="checkbox"/>
Glutathione Conjugation and hydrolyzation	8.950	616.0901	615.0726	<input checked="" type="checkbox"/>	98.2	<input checked="" type="checkbox"/>	<input checked="" type="checkbox"/>	<input checked="" type="checkbox"/>	<input checked="" type="checkbox"/>
Diclofenac	14.874	295.0746	294.0673	<input checked="" type="checkbox"/>	100.0	<input checked="" type="checkbox"/>	<input checked="" type="checkbox"/>	<input checked="" type="checkbox"/>	<input checked="" type="checkbox"/>

Name	RT	Mass	m/z	Qualified	Reference	User Qual	Qualified	Mass D.	Isotopic...
Hydrolyzation	11.576	311.0121	310.0049	<input checked="" type="checkbox"/>	100.0	<input checked="" type="checkbox"/>	<input checked="" type="checkbox"/>	<input checked="" type="checkbox"/>	<input checked="" type="checkbox"/>
Diclofenac	14.710	295.0716	294.0673	<input checked="" type="checkbox"/>	100.0	<input checked="" type="checkbox"/>	<input checked="" type="checkbox"/>	<input checked="" type="checkbox"/>	<input checked="" type="checkbox"/>

Page 39

Agilent Technologies

6530 QTOF Applications Overview
LCMS - ASMS 2008
Agilent Restricted

Our Agenda...

- Start with the Agilent R&D History
- New product specifications. They're fantastic!
- Learn about Agilent Jet Stream Technology
- Discover a new level of QTOF performance in the 6530 QTOF
- Find out how software innovation makes old workflows better and new workflows possible

Page 40

Agilent Technologies

LCMS - ASMS 2008
Agilent Restricted

Intact Protein MFE for Comprehensive Protein Mining in Chromatographic Separations

e. coli cytosolic proteins (intact)

Protein compound EIC's and TCC

Charge states for protein compound

Protein masses in compound list

Page 43

Agilent Technologies

LCMS - ASMS 2008
Agilent Restricted

MFE Results of Keller Mix in Mass Profiler

Currently under development, supported in future release

This should prove to be a powerful tool for analyzing batch to batch variations in the production of Biologics.

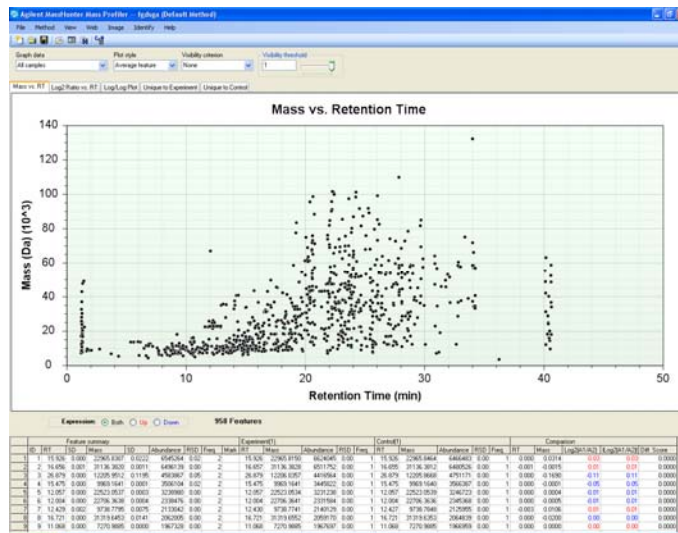



Page 46

 Agilent Technologies

LCMS - ASMS 2008
Agilent Restricted